



ULTRAHEAT

The Premier Range

Radiators and Towel Rails

2022 GBP





Klon Horizontal
KD628W White RAL 9016
£834.10^{+VAT}



Windsor Towel Rail
WIN5W8C Chrome
£240.17^{+VAT}

A warm welcome to Ultraheat and our stylish range of radiators and heated towel rails.

Our products represent a mix of traditional, timeless designs and bold, contemporary chic to match any interior décor trend.

We are dedicated to creating exactly what our customers want. Our talented teams stay ahead of the curve to design beautiful, affordable products to enhance any room.

At Ultraheat, we pride ourselves on our hard-earned reputation for quality engineering and exacting quality control.

We hope you enjoy browsing our stunning collections and look forward to helping you turn up the heat on your perfect radiator design.

Towel Rails	10
Tubular Radiators	22
Panel Radiators	41
Aluminium Radiators	55
RAL Colours	84
Exclusive Aluminium Finishes	86
Valves Compatibility	88
Valves & Accessories	90
Terms of Delivery	106
Terms and Conditions	107

Technical specifications are subject to change without prior notice. The colours shown in the imagery, while a good representation, may not be an exact match of the finished product.

© Pitacs Limited 2022

Ownership and intellectual property rights of the designs in this publication belong to Pitacs Limited and are registered in the UK and major trademark and design registry offices worldwide.

Please note: Pricing is stated; excluding VAT. Subject to change without prior notice. All mentioned products are subject to misprints. For consequences of misprints no liability is accepted. Prices published and updated May 2022.

ULTRAHEAT

THE BENEFITS



Fast delivery worldwide
Call 01908 271155



State-of-the-art distribution centre



Precision engineering
at the Ultraheat factory



For more information, visit
www.ultraheat.co.uk

PIT▲CS

Ultraheat is the heating division of The Pitacs Group

UK
CA

CE

EN **442**
EURO
NORM



Quality certified to British and European standards

TOWEL RAILS



11 Buckingham
Radiator with Heated Towel Rail
H



12 Chelmsford Arched
Heated Towel Rail
E H D



13 Chelmsford Straight
Heated Towel Rail
E H D



14 Devon
Radiator with Heated Towel Rail
H



15 Eco Rail
Heated Towel Rail
E H D



16 Hampton
Radiator with Heated Towel Rail
H



17 Karnak
Heated Towel Rail
E H D



18 Petit
Heated Towel Rail
E H D



19 Poplar
Heated Towel Rail
E H D



20 Portofino
Heated Towel Rail
E H D

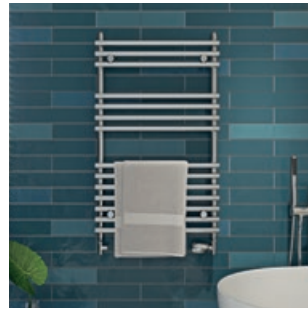

21 Windsor
Heated Towel Rail
E H D

E = Electric
H = Hot Water
D = Dual Fuel

TUBULAR RADIATORS



23 2 Column

Radiator
H



24 3 Column

Radiator
H



27 4 Column

Radiator
H



28 6 Column

Radiator
H



29 Imperium

Radiator
E H D



30 Klon Horizontal

Radiator
H



31 Klon Vertical

Radiator
E H D



32 Linear Horizontal

Radiator
H



32 Linear O

Radiator
H



33 Linear Vertical

Radiator
E H D



34 Sofi Horizontal

Radiator
H



35 Sofi Vertical

Radiator
E H D



36 Tian

Radiator
H



38 Tilbrook

Radiator
E H D



40 Trojan

Radiator
E H D

PANEL RADIATORS



42 **Compact 4**

Radiator
H



44 **New Panel Radiators**

Radiator
H



46 **Lanner Horizontal**

Radiator
H



47 **Lanner Vertical**

Radiator
H



48 **LSOrad**

Radiator
H



50 **Planal Horizontal**

Radiator
H



51 **Planal Vertical**

Radiator
H



52 **Sovran Horizontal**

Radiator
H



53 **Sovran Vertical**

Radiator
H



54 **Hypo**

Heat Exchange Convect
H

ALUMINIUM RADIATORS



56 Argus

Radiator
H



58 Banio

Heated Towel Rail
E H D



60 Bombe

Radiator
H



62 Diana

Heated Towel Rail
E H D



63 Heran

Radiator with Towel Bar
E H D



64 Hestia

Heated Towel Rail
E H D



66 Kavis

Radiator
H



68 Kupka

Heated Towel Rail
E H D



70 Kural

Radiator
H



72 Luvre

Radiator
H



74 Mira

Radiator with Towel Bar
E H D



75 Plateau

Radiator with Towel Bar
H



76 Porte

Radiator
H



78 Smyrna

Radiator
H



80 Virtu

Radiator
H



82 Visage

Radiator
H

VALVES, ACCESSORIES & INFORMATION

84	RAL Colours and Metallic Finishes	99	Stoke: Analogue Heating Elements
86	Exclusive Aluminium Finishes	100	Oswest: Wi-Fi Enabled Smart Heating Elements
88	Valves Compatibility	101	Enables Standard Element to be controlled
90	Manual Valves	101	Airvents and Accessories
92	Thermostatic Valves	102	Clip-on Accessories Compatibility
95	H Valves	103	Clip-on Accessories
96	Adapting Sets, Tube Connectors & Reducing Kits	104	Central Heating Treatments
97	Heating Elements	105	Floor Brackets
97	Heat Transfer Liquid	105	Concealed Wall Brackets
97	Dual Fuel Components	105	RAL Colours (Chelmsford)
98	Analogue Heating Elements	106	Terms of Delivery
98	Aquarius: Analogue Heating Elements	107	Terms and Conditions
99	Mobus: Analogue Heating Elements		

USEFUL INFORMATION

Symbol Guide

Material

- MS** Mild Steel
- SS** Stainless Steel
- AL** Aluminium
- BR** Brass

Working Temperature

- 95°C
- 120°C

Heating System

- O** Open System
- C** Closed System

Pricing

- £** Ex VAT

Working Pressure

- 3.5 bar
- 6 bar
- 8 bar
- 10 bar

Mounting Position

- V** Vertical
- H** Horizontal

Warranty

- 5 YEARS
- 10 YEARS

Price Guide

Prices quoted in **BLACK** are our in-stock range.

Prices quoted in **RED** are bespoke sizes with a lead time of up to 10 weeks.

Prices quoted in **BLUE** are stocked, but require some lead time to custom paint or custom build. Please enquire upon order regarding lead time.

E H D

The price quoted refers to a product suitable for Hot Water. Electric and Dual Fuel options require additional elements; please contact Ultraheat for a quotation.

Heat Outputs

Where multiple finishes are available, heat outputs are stated for painted finishes; for chrome finishes in these ranges, quoted heat outputs should be reduced by 20%. Where chrome is the only finish, the exact heat output is shown in the table.

Towel Rails

The Ultraheat range of heated towel rails has been created with simplicity, elegance and reliability at its core. From compact designs that work perfectly in smaller spaces to expansive rail and radiator combinations that become the focal point of any room.

They can be incorporated into an existing central heating system for optimum convenience. In addition, selected models are also available as a stand-alone, fully electric option for spaces without any nearby central heating outlet.

We offer the UK's largest 'in-stock' range of heated towel rails, available for immediate delivery.



Buckingham	11
Chelmsford Arched	12
Chelmsford Straight	13
Devon	14
Eco Rail	15
Hampton	16
Karnak	17
Petit	18
Poplar	19
Portofino	20
Windsor	21





5BEC
White RAL 9010 radiator
with chrome rails

£409.00^{+VAT}

A choice of valves
for this radiator:

TLB850MC
Manual Valve
£79.93
^{+VAT}

CHRVC
Manual Valve
£136.19
^{+VAT}







Chrome rails

Buckingham

Wrap up warm

Modern practicality to suit a period home. The timeless, compact design combines traditional charm with top heating performance.

White RAL 9010 mild steel column radiator with a choice of rail finishes.

Buckingham				Rail Finishes				
PRODUCT	DIMENSIONS		HEAT OUTPUT ΔT 50 BTU					
	Height mm	Length mm		While stocks last C	Polished Rails P	Polished Gold Rails GP	Brushed Matt Rails S	Satin Gold Rails GS
5BE	951	438	1287	£409.00	£871.20	£1,616.67	£855.36	£1,539.69
7BE	951	530	1492		£970.20	£1,805.91	£955.49	£1,719.91
9BE	951	620	1807		£1,188.00	£2,211.31	£1,169.99	£2,106.01
13BE	951	802	2438		£1,537.80	£2,862.39	£1,514.51	£2,726.08



Scan for full
technical
specification

Valves and
Accessories
from page 90

MS SS   C V  £
Material Working Pressure Working Temp. Closed System Mounting Pos. Warranty Prices Ex. VAT

CHELMSFORD

Arched

7MA11C
Chrome

£405.69^{+VAT}



CYL850MC
Manual Valve
£40.49
^{+VAT}

TPC
Dual Fuel Component
£13.07
^{+VAT}

HE400
Heating Element
£75.68
^{+VAT}

Chelmsford Arched

A warm welcome

Contemporary design meets premium quality in this spacious, curved rail that would look at home in any kitchen or bathroom.



Scan for full technical specification

Valves and Accessories from page 90

See page 102 for clip-on accessories compatibility

Chelmsford Arched

PRODUCT	DIMENSIONS		HEAT OUTPUT	Finishes	
	Height mm	Length mm		White RAL 9016 W	Chrome C
4MA7	700	420	1052	£124.95	£217.45
4MA9	900	420	1298	£144.43	£256.40
4MA12	1200	420	1783	£172.01	£292.10
5MA7	764	500	1264	£137.93	£230.43
5MA11	1172	500	1895	£175.26	£298.59
5MA15	1467	500	2350	£227.19	£386.22
5MA17	1750	500	2889	£272.62	£490.07
6MA7	764	600	1530	£144.43	£240.17
6MA11	1172	600	2295	£204.47	£318.06
6MA15	1467	600	2841	£238.54	£423.54
6MA17	1750	600	3497	£303.45	£516.04
7MA7	764	750	1865	£180.13	£301.83
7MA11	1172	750	2797	£246.66	£405.69
7MA17	1750	750	4262	£326.17	£595.55

MS Material
 8 Working Pressure
 95°C Working Temp.
 C Closed System
 V Mounting Pos.
 5 YEARS Warranty
 £ Prices Ex. VAT



White RAL 9016
Model shown for illustration purposes only



Chelmsford Straight

Practical, reliable
and beautiful

Our Chelmsford range offers contemporary craftsmanship and engineering excellence. Accessories available to complete the look. A fully electric-ready option is also available.

5M11C
Chrome

£287.23^{+VAT}

A choice of valves for this radiator:

CYH850MC
Manual Valve
£47.30^{+VAT}

CYH850TC
Thermostatic Valve
£57.80^{+VAT}



Chelmsford Straight

PRODUCT	DIMENSIONS		HEAT OUTPUT ΔT 50 BTU	Finishes		
	Height mm	Length mm		White RAL 9016 W	Chrome C	Metallic Micrograin Black RAL 9005 B
3M8	790	310	922	£118.46	£210.96	
3M12	1195	310	1383	£133.07	£293.72	
4M7	700	420	1052	£120.08	£212.58	
4M9	900	420	1294	£136.31	£245.04	
4M12	1200	420	1779	£160.65	£279.11	
4M15	1467	420	2104	£186.62	£337.53	
5M7	764	500	1250	£134.69	£222.32	£150.26
5M9	900	500	1427	£149.29	£262.89	
5M11	1172	500	1875	£172.01	£287.23	£190.82
5M15	1467	500	2322	£214.20	£369.99	
5M17	1750	500	2858	£264.51	£472.22	£294.50
6M7	764	600	1516	£142.80	£235.30	£159.27
6M9	900	600	1731	£157.41	£283.98	
6M11	1172	600	2274	£178.50	£303.45	£198.34
6M15	1467	600	2770	£233.68	£413.80	
6M17	1750	600	3463	£298.59	£503.05	£332.06
7M7	764	750	1844	£175.26	£288.85	
7M11	1172	750	2770	£235.30	£389.46	
7M17	1750	750	4218	£345.65	£580.95	



Scan for full technical specification
Valves and Accessories from page 90
See page 102 for clip-on accessories
compatibility



**AVAILABLE AS
FULLY ELECTRIC
READY**
Scan for more on the
fully electric range



5M11W
White RAL 9016
£172.01^{+VAT}

CYL850MC
Manual Valve
£40.49^{+VAT}

CYH850TW
Thermostatic Valve
£70.66^{+VAT}

MS Working Pressure 8 Working Temp. 95°C Closed System C Mounting Pos. V Warranty 5 YEARS Prices Ex. VAT £



DE695P
Polished Stainless Steel Bars
with White RAL 9016
Mild Steel Column Radiator

£1,197.54 ^{+VAT}

CYH850MC
Manual Valve
£47.30 ^{+VAT}

CYH850TC
Thermostatic Valve
£57.80 ^{+VAT}

Devon

Industrially inspired

This mild steel column radiator (White RAL 9016) with a choice of stainless-steel looping towel rail options gives off definite art deco vibes. Stunning.



Scan for full technical specification

Valves and Accessories from page 90

Devon PRODUCT	DIMENSIONS		HEAT OUTPUT ΔT 50 BTU	Rail Finishes			
	Height mm	Length mm		Stainless Steel Polished Rails P	Stainless Steel Polished Gold Rails GP	Stainless Steel Brushed Matt Rails S	Stainless Steel Satin Gold Rails GS
DE665	910	560	1772	£1,128.97	£2,201.49	£1,111.89	£2,001.39
DE695	995	560	1803	£1,197.54	£2,335.22	£1,179.39	£2,122.90



DE695GP
Polished Gold Stainless Steel Rails
with White RAL 9016
Mild Steel Column Radiator

£2,335.22 ^{+VAT}

MS SS 8 95°C C V 5 YEARS £
Material Working Pressure Working Temp. Closed System Mounting Pos. Warranty Prices Ex. VAT



Eco Rail

Stylish and affordable

An affordable, versatile choice that fits into any bathroom effortlessly and stylishly. Choose from mirror chrome or anthracite. A fully electric-ready option is also available.

PRODUCT	DIMENSIONS		HEAT OUTPUT ΔT 50 BTU	Finishes	
	Height mm	Length mm		Chrome C	Anthracite RAL 7016 A
4E8	801	400	731	£146.05	
5E8	801	500	915	£159.03	£159.03
6E8	801	600	1093	£191.48	
4E10	950	400	844	£172.79	
5E10	950	500	1055	£201.22	
6E10	950	600	1260	£219.07	
4E12	1175	400	1069	£204.47	
5E12	1175	500	1335	£215.83	£215.82
6E12	1175	600	1598	£232.05	
4E15	1585	400	1462	£271.00	
5E15	1585	500	1827	£282.35	£282.37
6E15	1585	600	2186	£306.70	
5E17	1700	500	1967	£311.57	
6E17	1700	600	2353	£340.78	



Scan for full technical specification

Valves and Accessories from page 90

See page 102 for clip-on accessories compatibility



AVAILABLE AS FULLY ELECTRIC READY

Scan for more on the fully electric range

MS Material Working Pressure 8 Working Temp. 95°C Closed System C Mounting Pos. V

5 YEARS Warranty Prices Ex. VAT



5E15C
Chrome
£282.35
+VAT

CYL850MC
Manual Valve
£40.49+VAT

5E15A
Anthracite RAL 7016
£282.37+VAT

CYL850MA
Manual Valve
£40.11+VAT



5PHSP
Polished Stainless Steel rail with
White RAL 9016 Planal radiator

£376.30^{+VAT}

CYL850MC
Manual Valve
£40.49^{+VAT}



CYH850TW
Thermostatic Valve
£70.66^{+VAT}





Scan for full technical specification
Valves and Accessories from page 90

Hampton

Stand out from the crowd with this striking White RAL 9016 mild steel panel radiator and stainless steel or brass mitred towel rail combination. Powerful performance; flawless design.

Hampton with Compact 4				Rail Finishes		
PRODUCT	DIMENSIONS		HEAT OUTPUT ΔT 50 BTU			
	Height mm	Length mm		Stainless Steel Brushed Matt S	Stainless Steel Polished P	Brass Mitred *Polished Gold GP
4HS	400	734	1341	£256.05	£284.87	£283.11
5HS	500	734	1570	£270.99	£299.82	£296.11
6HS	600	734	1784	£281.65	£310.48	£305.38
7HS	700	734	1996	£292.89	£321.71	£315.14
9HS	900	734	2405	£338.48	£367.30	£354.79
4HH	400	734	1928	£293.74	£322.56	£315.89
5HH	500	734	2293	£311.54	£340.36	£331.37
6HH	600	734	2620	£329.05	£357.87	£346.59
7HH	700	734	2934	£361.22	£390.04	£374.57
9HH	900	734	3542	£413.29	£442.11	£419.84

Hampton with Planal				Rail Finishes		
PRODUCT	DIMENSIONS		HEAT OUTPUT ΔT 50 BTU			
	Height mm	Length mm		Stainless Steel Brushed Matt S	Stainless Steel Polished P	Brass Mitred *Polished Gold GP
4PHS	400	734	1341	£322.24	£351.06	£379.88
5PHS	500	734	1570	£347.48	£376.30	£405.12
6PHS	600	734	1784	£357.41	£386.23	£415.05
7PHS	700	734	1996	£390.93	£419.75	£448.57
9PHS	900	734	2405	£447.21	£476.03	£504.85
4PHH	400	734	1928	£364.53	£393.35	£422.17
5PHH	500	734	2293	£398.88	£427.70	£456.52
6PHH	600	734	2620	£431.98	£460.80	£489.62

Prices in **BLUE** are stocked, but require some lead time to custom paint or custom build. Please enquire upon order regarding lead time.

*Hampton Polished Gold Rails in Brass are available In Stock in a Mitred style; Polished Gold Rails in the curved style are a Made To Order item. Please discuss your requirements with your Ultraheat representative.

MS SS BR Working Pressure Working Temp. 95°C C V 5 YEARS Prices Ex. VAT

ULTRAHEAT

PREMIER RANGE

T: +44 (0)1908 010333 F: +44 (0)1908 640017 E: heating-sales@pitacs.com W: www.ultraheat.co.uk



5K10C
Chrome

£399.15^{+VAT}

CUL850MC
Manual Valve
£61.77^{+VAT}

CUH850MC
Manual Valve
£102.35^{+VAT}

Karnak

Spa luxury for all

Elegance in simplicity, this satisfyingly linear design offers quality heating and lots of room to keep towels cosy and warm. A fully electric-ready option is also available.

Karnak PRODUCT	DIMENSIONS		HEAT OUTPUT ΔT 50 BTU	Finishes	
	Height mm	Length mm		White RAL 9016 W	Chrome C
3K10	1000	310	678		£320.27
3K14	1440	310	960		£384.95
4K5	480	420	495	£153.04	£233.50
4K14	1440	420	1096		£462.26
5K10	1000	500	1124	£251.59	£399.15
5K14	1440	500	1246		£490.66
5K17	1700	500	1882	£332.90	£519.06



Scan for full technical specification

Valves and Accessories from page 90

See page 102 for clip-on accessories compatibility



AVAILABLE AS FULLY ELECTRIC READY

Scan for more on the fully electric range



4K5W
White RAL 9016

£153.04^{+VAT}

CUL850MC
Manual Valve
£61.77^{+VAT}

MS Working Pressure Working Temp. 95°C Closed System Mounting Pos. V 5 YEARS Warranty Prices Ex. VAT £

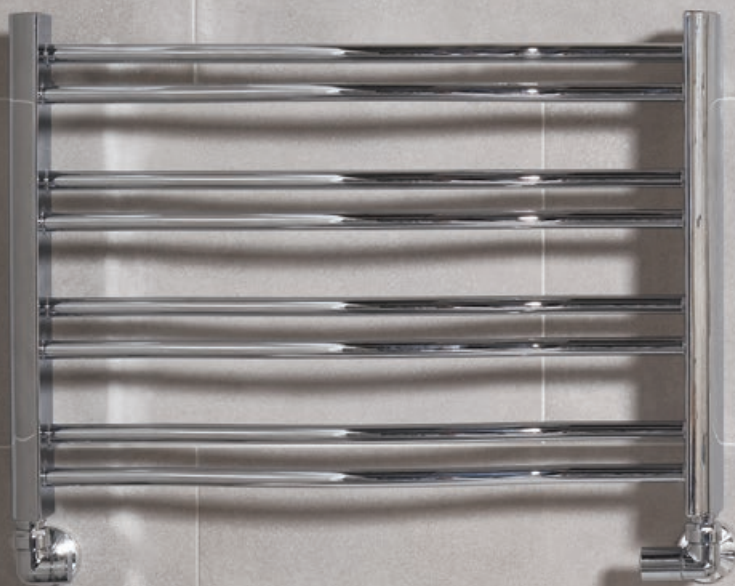

PETC46A
Chrome

£146.49^{+VAT}

CYH853MC
Manual Valve
£56.76^{+VAT}



Petit

Small is beautiful

Small is beautiful with this attractive, space-saving design that is practical and perfect for en suites, cloakrooms and compact areas.



Scan for full technical specification

Valves and Accessories from page 90

Petit			Finish	
PRODUCT	DIMENSIONS		HEAT OUTPUT	
	Height mm	Length mm	ΔT 50 BTU	Chrome
PETC46A	420	600	716	C £146.49

MS 6 95°C C V 5 YEARS £
 Material Working Pressure Working Temp. Closed System Mounting Pos. Warranty Prices Ex. VAT





5PO17W
White RAL 9016
£647.48^{+VAT}

CYH853MS
Manual Valve
£66.60^{+VAT}

Poplar

A touch of class

The sleek, tactile bars embrace the vertical columns in a contemporary design to complement any bathroom.

5PO11B
Metallic Micrograin
Black RAL 9005
£493.32
^{+VAT}



Poplar			Finishes			
PRODUCT	DIMENSIONS		HEAT OUTPUT	White	Chrome	Metallic Micrograin
	Height mm	Length mm		White RAL 9016 W	Chrome C	Metallic Micrograin Black RAL 9005 B
5PO7	788	500	1755	£387.84	£486.83	£402.44
5PO11	1106	500	2295	£473.84	£611.78	£493.32
5PO17	1742	500	3374	£647.48	£790.28	£673.44



Scan for full technical specification
Valves and Accessories from
page 90
See page 102 for clip-on
accessories compatibility

MS 6 95°C C V 5 YEARS £
 Material Working Pressure Working Temp. Closed System Mounting Pos. Warranty Prices Ex. VAT

POR6P12C
Chrome

£748.09 +VAT

CYH853MC
Manual Valve
£56.76 +VAT

Portofino

Curvaceous and fun

Add a fun, fashionable talking point to your bathroom with this curvy towel rail with convenient top towel storage rack.



Scan for full technical specification

Valves and Accessories from page 90

Portofino		DIMENSIONS		HEAT OUTPUT	Finish
PRODUCT	Height mm	Length mm	ΔT 50 BTU	Chrome	
POR5P12	1200	500	622	C	£694.53
POR6P12	1200	600	806		£748.09

MS Material
 6 Working Pressure
 95°C Working Temp.
 C Closed System
 V Mounting Pos.
 5 YEARS Warranty
 £ Prices Ex. VAT



POR5P12C
Chrome

£694.53 +VAT

WIN5W8C
Chrome
£240.17
+VAT



UDC851
Thermostatic Valve
£63.65+VAT

UDC109L
Sensor
£42.85+VAT

CYL851MC
Manual Valve
£41.28+VAT

Windsor

Exquisitely finished

This practical ladder rail would look at home in a contemporary bathroom, adding generous storage space and sleek, modern style.



WIN5W11W
White RAL 9016
£196.35
+VAT



Scan for full technical specification
Valves and Accessories from page 90
See page 102 for clip-on accessories compatibility

Windsor			Finishes		
PRODUCT	DIMENSIONS		HEAT OUTPUT ΔT 50 BTU	White	Chrome
	Height mm	Length mm		RAL 9016	C
WIN5W8	798	500	1287	£157.41	£240.17
WIN5W11	1150	500	1837	£196.35	£301.83
WIN5W16	1612	500	2848	£277.49	£443.01
WINE (pair)	Mild steel airvent caps			£12.02	£13.52

MS 6 95°C C V 5 YEARS £
 Material Working Pressure Working Temp. Closed System Mounting Pos. Warranty Prices Ex. VAT

Tubular Radiators

Tubular radiators from Ultraheat offer that enviable combination of sophisticated, stunning design with highly efficient and reliable heat performance.

Our wide range of designs span the gamut from chunky, traditional comfort to sharp, industrial chic. Whatever your perfect room looks like, we have the right tubular radiator for you.

2 Column	23
3 Column	24
Column Radiator Feet	26
4 Column	27
6 Column	28
Imperium	29
Klon Horizontal	30
Klon Vertical	31
Linear O	32
Linear Horizontal	32
Linear Vertical	33
Sofi Horizontal	34
Sofi Vertical	35
Tian	36
Tilbrook	38
Trojan	40



C2180408W
White RAL 9016

£396.78^{+VAT}

BHC
Chrome
Button Robe Hanger (Pair)
£28.27^{+VAT}

2 Column

Effective heating

Efficient, reliable and smart enough to look good at home or work. This practical design fits seamlessly into any room.

TLB850MC
Manual Valve
£79.93^{+VAT}

2 Column			Finishes				
PRODUCT	DIMENSIONS		HEAT OUTPUT ΔT 50 BTU				
	Height mm	Length mm		White RAL 9016 W	Anthracite RAL 7016 A	Other Solid RAL Colour R	Metallic Micrograin T
C2050613	500	598	1628	£320.76		£526.05	£589.17
C2050716	500	731	2003	£418.97		£691.30	£774.25
C2050922	500	997	2755	£532.99		£879.43	£984.96
C2051125	500	1130	3130	£618.26		£1,020.13	£1,142.55
C2051432	500	1440	4007	£842.00		£1,389.31	£1,556.02
C2060306	600	288	902	£163.42	£179.29	£236.96	£265.39
C2060408	600	376	1202	£216.15	£237.14	£315.58	£353.45
C2060409	600	421	1352	£243.75	£267.41	£358.31	£401.30
C2060613	600	598	1953	£330.59	£362.69	£545.48	£610.93
C2060716	600	731	2404	£419.29	£460.00	£670.86	£751.37
C2060919	600	864	2855	£474.99	£521.11	£759.98	£851.18
C2060922	600	997	3306	£594.64		£981.16	£1,098.89
C2061125	600	1130	3757	£669.48	£734.48	£1,104.64	£1,237.20
C2061432	600	1440	4808	£863.08	£946.87	£1,320.51	£1,478.97
C2061636	600	1617	5409	£971.92		£1,496.76	£1,676.37
C2061640	600	1794	6010	£1,200.70		£1,861.09	£2,084.42
C2070409	750	421	1690	£306.23		£450.16	£504.18
C2070613	750	598	2442	£442.48		£654.88	£733.46
C2070716	750	731	3005	£544.41		£811.17	£908.51
C2070919	750	864	3569	£646.49		£963.26	£1,078.86
C2070922	750	997	4132	£748.56		£1,122.84	£1,257.59

2 Column			Finishes				
PRODUCT	DIMENSIONS		HEAT OUTPUT ΔT 50 BTU				
	Height mm	Length mm		White RAL 9016 W	Anthracite RAL 7016 A	Other Solid RAL Colour R	Metallic Micrograin T
C2090408	900	376	1776	£263.68	£289.27	£390.24	£437.07
C2090510	900	465	2220	£329.59		£491.10	£550.03
C2120408	1200	376	2377	£315.80		£473.70	£530.54
C2120510	1200	465	2971	£461.47		£696.82	£780.44
C2150408	1500	376	2951	£367.92		£555.56	£622.22
C2150510	1500	465	3688	£459.90		£699.05	£782.93
C2180204	1800	199	1762	£225.35		£349.29	£391.21
C2180306	1800	288	2643	£320.40	£351.50	£499.82	£559.80
C2180408	1800	376	3524	£396.78	£435.31	£587.24	£657.71
C2180510	1800	465	4542	£499.54	£548.04	£734.32	£822.44
C2180613	1800	598	5905	£664.19		£989.65	£1,108.40
C2200408	2000	376	3907	£427.71		£684.33	£766.45
C2200510	2000	465	4883	£535.02		£877.43	£982.72
C2200613	2000	598	6348	£703.54		£1,125.66	£1,260.74
C2FT	202	30		£39.86	£43.73	£66.96	£75.00

Scan for full technical specification

Valves and Accessories from page 90

See page 102 for clip-on accessories compatibility



C2061125SR
Sulfur Yellow RAL 1016

£1,104.64^{+VAT}

- Material
- Working Pressure
- Working Temperature
- Closed System
- Mounting Position
- Warranty
- Prices Ex. VAT

C3180408W
White RAL 9016
£520.97
+VAT



C3060919A
Anthracite RAL 7016
£627.09+VAT



C3FTA
Anthracite RAL 7016
Column Feet (Pair)
£60.63+VAT

CYL850MA
Anthracite RAL 7016
Manual Valve
£40.11+VAT

3 Column

Simple and elegant

Pleasingly tactile; efficiently warm. A powerful radiator that will heat up the home from any position.



Scan for full technical specification
Valves and Accessories from page 90
See page 102 for clip-on accessories compatibility

3 Column			Finishes				
PRODUCT	DIMENSIONS		HEAT OUTPUT ΔT 50 BTU				
	Height mm	Length mm		White RAL 9016 W	Anthracite RAL 7016 A	Other Solid RAL Colour R	Metallic Micrograin T
C3030919	300	864	2141	£465.13		£781.42	£875.19
C3031125	300	1130	2817	£580.10		£974.56	£1,091.51
C3031432	300	1440	3606	£691.39		£1,133.88	£1,269.95
C3031636	300	1617	4057	£837.57		£1,381.99	£1,547.83
C3040409	400	421	1291	£242.33		£375.62	£420.69
C3040613	400	598	1865	£330.24	£426.14	£544.90	£610.29
C3040716	400	731	2295	£406.42	£505.83	£625.89	£701.00
C3040919	400	864	2725	£482.60	£569.92	£752.86	£843.20
C3040922	400	997	3155	£558.83	£659.91	£882.95	£988.91
C3041125	400	1130	3586	£635.07	£750.08	£1,016.12	£1,138.05
C3041432	400	1440	4590	£812.83	£959.69	£1,316.79	£1,474.80
C3041636	400	1617	5163	£914.42		£1,499.65	£1,679.61
C3041640	400	1794	5737	£1,028.94		£1,708.03	£1,913.00
C3050409	500	421	1567	£245.23		£372.75	£417.48
C3050613	500	598	2264	£353.46		£583.21	£653.20
C3050716	500	731	2787	£431.34		£711.72	£797.13
C3050919	500	864	3309	£512.24	£604.57	£845.19	£946.62
C3050922	500	997	3832	£593.26	£681.55	£949.22	£1,063.13
C3051125	500	1130	4354	£685.67	£796.85	£1,062.79	£1,190.32
C3051432	500	1440	5573	£880.73	£1,018.58	£1,409.16	£1,578.26
C3051636	500	1617	6270	£1,027.59		£1,644.15	£1,841.44
C3051640	500	1794	6967	£1,155.75		£1,906.98	£2,135.82
C3060306	600	288	1250	£180.89		£271.34	£303.90
C3060408	600	377	1667	£240.68		£365.83	£409.73
C3060409	600	421	1875	£263.68		£408.70	£457.74
C3060613	600	598	2708	£380.18	£429.61	£608.29	£681.29
C3060716	600	731	3333	£470.63	£531.81	£757.71	£848.64
C3060919	600	864	3958	£547.29	£627.09	£875.67	£980.75
C3060922	600	997	4583	£644.12	£728.10	£998.38	£1,118.19
C3061125	600	1130	5208	£720.20	£824.57	£1,152.33	£1,290.61
C3061432	600	1440	6666	£921.79	£1,054.96	£1,474.86	£1,651.84
C3061636	600	1617	7499	£1,049.07		£1,678.50	£1,879.93
C3061640	600	1794	8333	£1,260.74		£1,930.23	£2,161.86

3 Column			Finishes				
PRODUCT	DIMENSIONS		HEAT OUTPUT ΔT 50 BTU				
	Height mm	Length mm		White RAL 9016 W	Anthracite RAL 7016 A	Other Solid RAL Colour R	Metallic Micrograin T
C3070306	750	288	1865	£210.98		£333.35	£373.36
C3070408	750	377	2486	£281.31		£450.10	£504.11
C3070409	750	421	2797	£316.48		£512.69	£574.21
C3070613	750	598	4040	£457.13		£749.70	£839.66
C3070716	750	731	4972	£562.62		£933.95	£1,046.03
C3070919	750	864	5905	£643.26		£1,080.68	£1,210.37
C3070922	750	997	6837	£742.54		£1,262.32	£1,413.80
C3071125	750	1130	7769	£879.10		£1,512.05	£1,693.50
C3071432	750	1440	9944	£1,111.21		£1,933.51	£2,165.53
C3071636	750	1617	11188	£1,206.20		£2,122.92	£2,377.67
C3180306	1800	288	3668	£385.23	£419.21	£616.37	£690.34
C3180408	1800	377	4890	£520.97	£559.53	£833.56	£933.58
C3180409	1800	421	5502	£622.42		£1,014.55	£1,136.30
C3180510	1800	465	6113	£699.20	£698.11	£1,160.67	£1,299.95
C3180613	1800	598	7947	£914.91	£907.72	£1,408.97	£1,578.04
C3200306	2000	288	4055	£417.33		£688.60	£771.23
C3200408	2000	377	5406	£564.39		£931.24	£1,042.99
C3200409	2000	421	6082	£674.29		£1,112.58	£1,246.09
C3200510	2000	465	6758	£757.46		£1,249.81	£1,399.79
C3200613	2000	598	8786	£991.16		£1,635.41	£1,831.66
C3FT	202	30		£53.65	£60.63	£88.53	£99.15





- Material
- Working Pressure
- Working Temperature
- Closed System
- Mounting Position
- Warranty
- Prices Ex. VAT



2 Column Feet

C2FT

Feet for 2 Column Radiator
(Pair)



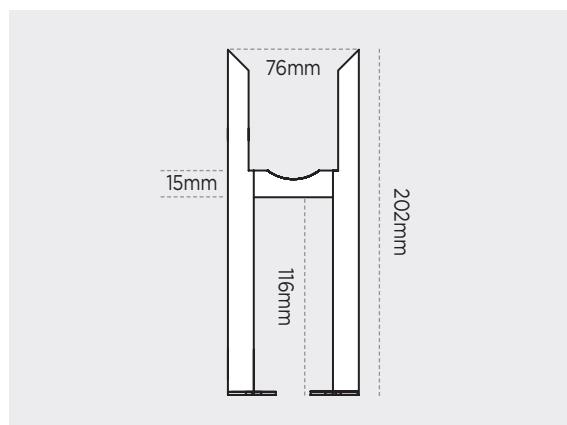

	White RAL 9016	£39.86
	Anthracite RAL 7016	£43.73
	Other RAL Colours	£66.96
	Metallic Micrograin	£75.00



3 Column Feet

C3FT

Feet for 3 Column Radiator
(Pair)

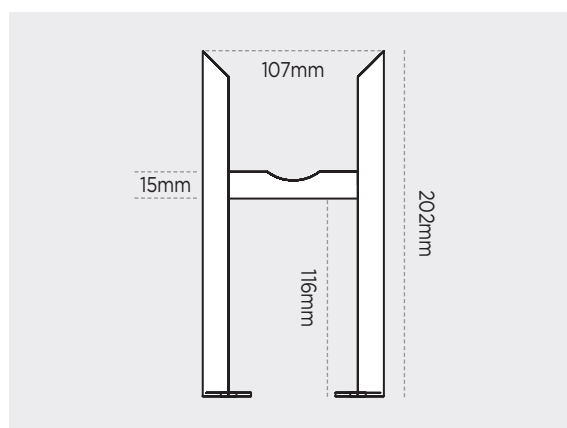

	White RAL 9016	£53.65
	Anthracite RAL 7016	£60.63
	Other RAL Colours	£88.53
	Metallic Micrograin	£99.15



4 Column Feet

C4FT

Feet for 4 Column Radiator
(Pair)

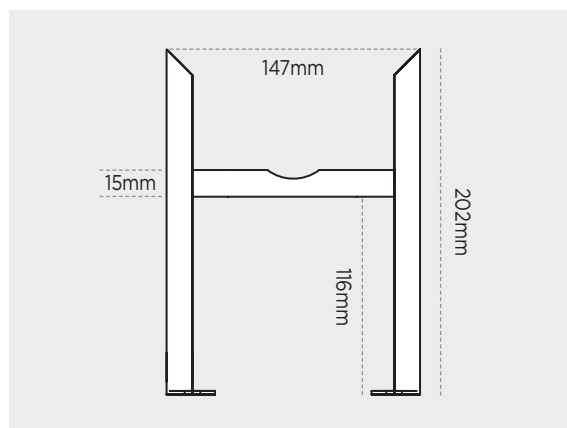

	White RAL 9016	£65.92
	Other RAL Colours	£115.36
	Metallic Micrograin	£129.20



6 Column Feet

C6FT

Feet for 6 Column Radiator
(Pair)

	White RAL 9016	£93.61
	Other RAL Colours	£163.81
	Metallic Micrograin	£183.47

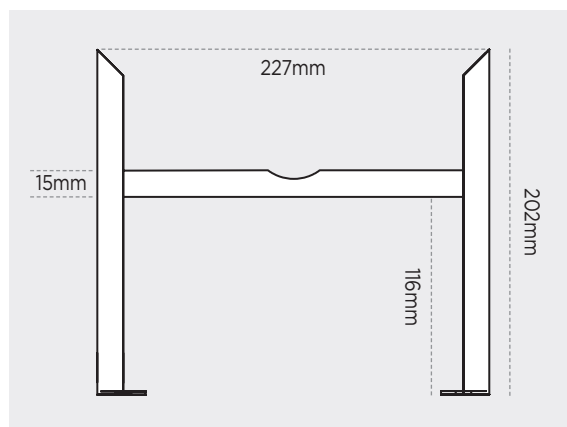



C4060919W
White RAL 9016
£630.07^{+VAT}

TLB850MC
Manual Valve
£79.93^{+VAT}

4 Column

This timeless classic really means it when it comes to providing excellent heat output, along with unmistakable, iconic style.



Scan for full technical specification

Valves and Accessories from page 90

See page 102 for clip-on accessories compatibility



4 Column			Finishes			
PRODUCT	DIMENSIONS		HEAT OUTPUT ΔT 50 BTU	White	Other Solid	Metallic
	Height mm	Length mm		RAL 9016 W	RAL Colour R	Micrograin T
C4030919	300	864	2855	£643.68	£862.53	£966.03
C4031125	300	1130	3757	£771.46	£1,033.76	£1,157.81
C4031432	300	1440	4808	£929.26	£1,245.20	£1,394.63
C4040613	400	598	2575	£398.26	£637.21	£713.68
C4040716	400	731	3169	£515.04	£824.07	£922.96
C4040919	400	864	3763	£596.75	£895.12	£1,002.54
C4040922	400	997	4358	£690.84	£1,036.26	£1,160.61
C4041125	400	1130	4952	£785.06	£1,193.30	£1,336.49
C4041432	400	1440	6338	£1,029.36	£1,564.63	£1,752.38
C4050613	500	598	3196	£430.27	£623.90	£698.76
C4050716	500	731	3934	£588.60	£888.78	£995.44
C4050919	500	864	4672	£622.95	£921.97	£1,032.61
C4050922	500	997	5409	£768.82	£1,153.23	£1,291.61
C4051125	500	1130	6147	£877.57	£1,298.80	£1,454.66
C4051432	500	1440	7868	£1,015.38	£1,502.77	£1,683.10

4 Column			Finishes			
PRODUCT	DIMENSIONS		HEAT OUTPUT ΔT 50 BTU	White	Other Solid	Metallic
	Height mm	Length mm		RAL 9016 W	RAL Colour R	Micrograin T
C4060409	600	421	2643	£301.69	£467.63	£523.74
C4060613	600	598	3818	£432.59	£692.14	£775.19
C4060716	600	731	4699	£549.33	£851.47	£953.64
C4060919	600	864	5580	£630.07	£976.61	£1,093.81
C4060922	600	997	6461	£773.97	£1,199.65	£1,343.61
C4061125	600	1130	7342	£883.76	£1,369.82	£1,534.20
C4061432	600	1440	9398	£1,094.62	£1,641.93	£1,838.97
C4070409	750	421	3289	£375.05	£581.32	£651.08
C4070613	750	598	4750	£581.36	£901.11	£1,009.25
C4070716	750	731	5846	£715.67	£1,109.29	£1,242.40
C4070919	750	864	6943	£849.69	£1,359.50	£1,522.64
C4070922	750	997	8039	£984.06	£1,574.49	£1,763.43
C4071125	750	1130	9135	£1,118.02	£1,788.83	£2,003.49
C4FT	202	30		£65.92	£115.36	£129.20

- Material
- Working Pressure
- Working Temperature
- Closed System
- Mounting Position
- Warranty
- Prices Ex. VAT

C6050716R
Anthracite RAL 7016

£1,582.44^{+VAT}

QUA850MC
Manual Valve
£66.97
^{+VAT}



6 Column

Warmth with charm

We're getting serious now, with this chunky, charming radiator that's king of the heaters and prince of the period home.



Scan for full technical specification
Valves and Accessories from page 90
See page 102 for clip-on accessories compatibility



C6030919W White RAL 9016
£953.04^{+VAT}

6 Column

PRODUCT	DIMENSIONS		HEAT OUTPUT ΔT 50 BTU	Finishes		
	Height mm	Length mm		White RAL 9016 W	Other Solid RAL Colour R	Metallic Micrograin T
C6030919	300	864	4282	£953.04	£1,534.39	£1,718.51
C6031125	300	1130	5635	£1,254.21	£2,019.27	£2,261.59
C6031632	300	1440	7212	£1,788.04	£2,878.75	£3,224.20
C6031636	300	1617	8114	£1,969.80	£3,171.39	£3,551.95
C6050409	500	421	3350	£552.83	£890.05	£996.86
C6050613	500	598	4839	£799.06	£1,286.48	£1,440.86
C6050716	500	731	5956	£982.88	£1,582.44	£1,772.33
C6050919	500	864	7072	£1,167.38	£1,879.49	£2,105.03
C6051225	500	1130	9306	£1,535.71	£2,472.49	£2,769.19
C6051636	500	1617	13400	£2,190.96	£3,527.45	£3,950.74
C6060409	600	421	3996	£552.83	£890.05	£996.86
C6060613	600	598	5771	£799.06	£1,286.48	£1,440.86
C6060716	600	731	7103	£982.88	£1,582.44	£1,772.33
C6060919	600	864	8435	£1,167.38	£1,879.49	£2,105.03
C6060922	600	997	9767	£1,351.71	£2,176.25	£2,437.41
C6061225	600	1130	11099	£1,535.71	£2,472.49	£2,769.19
C6061632	600	1440	14206	£2,190.96	£3,527.45	£3,950.74
C6FT	202	227		£93.61	£163.81	£183.47

MS

Material

6

Working
Pressure

95°C

Working
Temperature

C

Closed
System

V

Mounting
Position

5 YEARS

Warranty

£

Prices
Ex. VAT



Imperium

Warm with style

Who says radiators have to be boring? Turn your heat source into an eye-catching display with this tall, contemporary design.



Scan for full technical specification

Valves and clip-on accessories from page 90

See page 102 for clip-on accessories compatibility

Imperium				Finish
PRODUCT	DIMENSIONS		HEAT OUTPUT	Chrome
	Height mm	Length mm	ΔT 50 BTU	
5IM13	1300	260	1786	£473.85
5IM18	1800	260	2456	£600.41

- MS
Material
- 6
Working Pressure
- 95°C
Working Temperature
- C
Closed System
- V
Mounting Position
- 5 YEARS
Warranty
- £
Prices Ex. VAT

5IM18C Chrome
£600.41^{+VAT}

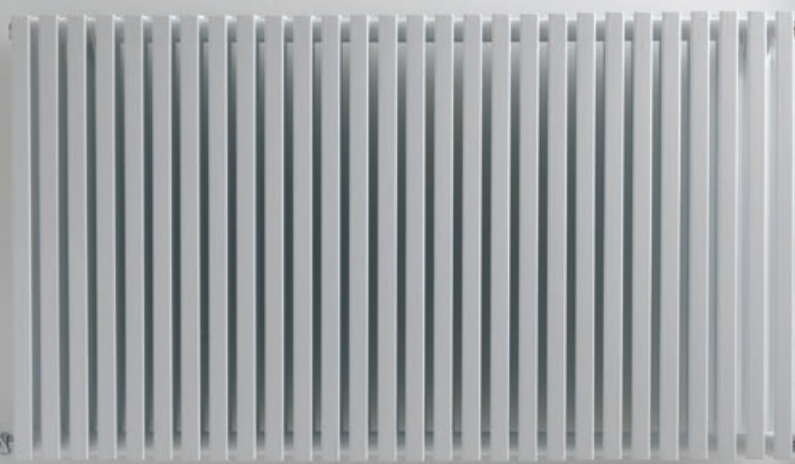
KD628W
 White RAL 9016
£834.10^{+VAT}

 CYH850TW
 Thermostatic Valve
£70.66^{+VAT}

Klon Horizontal

D-shaped profile

Give your walls a design twist with this unusual, D-shaped radiator that is sturdy, simple, yet utterly stunning.



Scan for full technical specification

Valves and Accessories from page 90

See page 102 for clip-on accessories compatibility

Klon Horizontal

PRODUCT	DIMENSIONS		HEAT OUTPUT ΔT 50 BTU	Finishes					
	Height mm	Length mm		White RAL 9016 W	Metallic Micrograin Black RAL 9005 B	Grey RAL 7015 GY	Other Solid RAL Colour R	Metallic Micrograin T	
KD416	420	611	2623	£399.62	£455.56	£455.56	£631.40	£694.54	
KD422	420	839	3607	£535.06	£609.97	£609.97	£845.39	£929.93	
KD428	420	1067	4591	£674.52	£768.96	£768.96	£1,065.75	£1,172.32	
KD432	420	1219	5246	£771.07	£879.03	£879.03	£1,218.30	£1,340.13	
KD436	420	1371	5902	£870.31	£992.15	£992.15	£1,375.09	£1,512.60	
KD614	600	535	3200	£423.76		£460.57	£669.53	£736.49	
KD616	600	611	3658	£486.78	£554.93	£617.78	£769.12	£846.03	
KD622	600	839	5031	£661.11	£753.67	£784.20	£1,044.56	£1,149.01	
KD628	600	1067	6408	£834.10	£950.88	£950.88	£1,317.88	£1,449.67	
KD632	600	1219	7323	£942.72	£1,074.70	£1,074.70	£1,489.50	£1,638.45	
KD636	600	1371	8238	£1,133.14	£1,291.78	£1,291.78	£1,790.37	£1,969.41	
KD642	600	1599	9611	£1,308.82			£2,094.10	£2,316.81	



KD628B
 Metallic Micrograin
 Matt Black RAL 9005

£950.88
^{+VAT}

Material
 Working Pressure
 Working Temp.
 Closed System
 Mounting Pos.
 Warranty
 Prices Ex. VAT

KS1510B
Metallic Micrograin
Matt Black RAL 9005
£366.90^{+VAT}

CYH850TS
Thermostatic Valve
£70.00^{+VAT}







Klon Vertical

Standing tall

Go big or go home... to this striking radiator that will turn heads and warm hearts. Suitable for any room.



KS1806C Chrome
£639.49^{+VAT}

Klon Vertical				Finishes					
PRODUCT	DIMENSIONS		HEAT OUTPUT						
	Height mm	Length mm		White RAL 9016 W	Chrome C	Metallic Micrograin Black RAL 9005 B	Grey RAL 7015 GY	Other Solid RAL Colour R	Metallic Micrograin T
KS1506	1500	231	1411		£527.18				
KS1510	1500	383	2937	£321.84	£655.38	£366.90	£366.90	£508.51	£559.36
KS1512	1500	459	2821		£794.61				
KS1806	1800	231	1691		£639.49				
KS1810	1800	383	3483	£358.05	£781.44	£408.17	£408.17	£565.71	£622.29
KS1816	1800	611	5573	£557.86	£1,167.08	£635.96	£635.96	£881.41	£969.55
KS2006	2000	231	1879		£709.13				
KS2014	2000	535	4047		£1,024.35				
KD1506	1500	231	2879	£325.86				£514.86	£566.35
KD1510	1500	383	4798	£532.36		£606.90	£606.90	£841.14	£925.25
KD1514	1500	535	6717	£732.19				£1,156.85	£1,272.54
KD1806	1800	231	3719	£372.80		£424.99	£424.99	£589.02	£647.92
KD1810	1800	383	6198	£624.91		£712.39	£712.39	£987.35	£1,086.09
KD1812	1800	459	7438	£744.25				£1,175.92	£1,293.51
KD1814	1800	535	8678	£859.58		£979.92	£979.92	£1,358.14	£1,493.95
KD2014	2000	535	9611	£942.72					



Scan for full technical specification

Valves and Accessories from page 90

See page 102 for clip-on accessories compatibility

MS Working Pressure Working Temp. Closed System Mounting Pos. Warranty 5 YEARS Prices Ex. VAT

Linear O

Simply red,
simply beautiful

Who's succumbed to 'scarlet' fever? We know we have with this bright red beauty.

Available while stocks last.



Scan for full technical specification

Valves and Accessories from page 90

See page 102 for clip-on accessories compatibility



Linear O			Finish		
PRODUCT	DIMENSIONS		HEAT OUTPUT	Metallic Micrograin	
	Height mm	Length mm		ΔT 50 BTU	Matt Red R
Linear 5L18	1800	252	2380	£172.00	

While stocks last

Material
 Working Pressure
 Working Temp.
 Closed System
 Mounting Pos.
 Warranty
 Prices Ex. VAT

Linear 5L18R
Red

£172.00^{+VAT}



LD606W
White RAL 9016
£274.26^{+VAT}

Linear Horizontal

Compact cosiness

Great for smaller rooms, or when you simply want your radiator to produce reliable, reassuring heat. Simply beautiful.



Scan for full technical specification

Valves and Accessories from page 90

See page 102 for clip-on accessories compatibility

Linear Horizontal				Finishes				
PRODUCT	DIMENSIONS		HEAT OUTPUT					
	Height mm	Length mm		White RAL 9016 W	Metallic Micrograin Black RAL 9005 B	Grey RAL 7015 GY	Other Solid RAL Colour R	Metallic Micrograin T
LD606	600	321	1476	£274.26			£452.52	£497.78
LD608	600	427	1967	£365.68	£473.72	£473.72	£603.37	£663.70
LD610	600	533	2459	£426.11			£703.07	£773.38
LD612	600	639	2951	£491.18	£636.31	£636.31	£810.45	£891.50
LD614	600	745	3443	£557.81			£920.39	£1,012.43
LD616	600	851	3935	£607.39	£786.84	£786.84	£1,002.20	£1,102.42
LD618	600	957	4427	£691.30	£895.56	£895.56	£1,140.64	£1,254.71
LD620	600	1063	4918	£757.69	£981.56	£981.56	£1,250.19	£1,375.21
LD623	600	1222	5656	£882.01	£1,142.60	£1,142.60	£1,455.31	£1,600.84
LD627	600	1434	6640	£1,047.68			£1,728.67	£1,901.53
LD631	600	1646	7624	£1,203.94			£1,986.50	£2,185.15
LD635	600	1858	8607	£1,366.64			£2,254.95	£2,480.44
LD638	600	2017	9345	£1,485.95			£2,451.81	£2,696.99

Material
 Working Pressure
 Working Temp.
 Closed System
 Mounting Pos.
 Warranty
 Prices Ex. VAT



Linear Vertical

Feel the heat







A sleek, shimmering design that stands tall to reflect light and radiate heat just the way you want it to.



Scan for full technical specification

Valves and Accessories from page 90

See page 102 for clip-on accessories compatibility

Linear Vertical				Finishes					
PRODUCT	DIMENSIONS		HEAT OUTPUT ΔT 50 BTU						
	Height mm	Length mm		White RAL 9016 W	Chrome C	Metallic Micrograin Black RAL 9005 B	Grey RAL 7015 GY	Other Solid RAL Colour R	Metallic Micrograin Paint T
LS1505	1500	268	1486	£255.66	£618.03			£421.84	£464.03
LS1507	1500	374	2080	£348.63	£747.07	£451.64	£478.74	£575.24	£632.77
LS1509	1500	480	2674	£424.56	£874.41			£700.52	£770.57
LS1805	1800	268	1810	£309.89	£699.53	£401.45	£425.54	£511.33	£562.46
LS1807	1800	374	2534	£388.92	£848.94	£503.83	£534.06	£641.71	£705.89
LS1809	1800	480	3258	£480.34	£1,008.54	£622.25	£659.59	£792.56	£871.81
LS2005	2000	268	2015	£388.25	£764.05			£640.61	£704.67
LS2007	2000	374	2258		£928.74				
LS2009	2000	480	2903		£1,100.23				
LD1505	1500	268	2579	£467.26				£770.97	£848.07
LD1507	1500	374	3921	£545.13		£722.62	£765.97	£899.47	£989.42
LD1805	1800	268	3381	£455.79		£604.19	£640.44	£752.06	£827.26
LD1807	1800	374	4734	£616.30		£824.63		£1,016.90	£1,118.59
LD1809	1800	480	6087	£790.44		£1,047.80	£1,110.66	£1,304.23	£1,434.65
LD1811	1800	586	7439	£946.41				£1,561.58	£1,717.74
LD2005	2000	268	3723	£498.19				£822.02	£904.22
LD2009	2000	480	6701	£838.90		£1,112.03	£1,178.75	£1,384.18	£1,522.60

MS 6 95°C C V 5 YEARS £
 Material Working Pressure Working Temp. Closed System Mounting Pos. Warranty Prices Ex. VAT

LD1805W
White RAL 9016
£455.79^{+VAT}

UDW850
Thermostatic Valve
£63.65^{+VAT}

TWU850TW
Thermostatic Valve
£127.33^{+VAT}





LS2005C
Chrome
£764.05^{+VAT}







Sofi Horizontal

Beauty in simplicity

Elegant, exquisite elliptical tubes. Soft and sensual, this radiator is as luxurious to the touch as it is warm.



Sofi Horizontal			Finishes			
PRODUCT	DIMENSIONS		HEAT OUTPUT ΔT 50 BTU			
	Height mm	Length mm		White RAL 9016 W	Other Solid RAL Colour R	Metallic Micrograin T
SD608	600	475	2268	£311.38	£507.55	£558.31
SD610	600	593	2835	£406.85	£663.17	£729.49
SD612	600	711	3402	£484.70	£790.06	£869.06
SD614	600	829	3969	£546.39	£890.61	£979.68
SD616	600	947	4536	£621.30	£1,012.72	£1,113.99
SD618	600	1065	5103	£697.67	£1,102.33	£1,212.56
SD620	600	1183	5670	£765.24	£1,247.34	£1,372.08
SD622	600	1301	6237	£834.27	£1,359.86	£1,495.85
SD624	600	1419	6804	£970.26	£1,581.52	£1,739.67
SD626	600	1537	7371	£1,042.83	£1,699.81	£1,869.80
SD628	600	1655	7938	£1,116.97	£1,820.66	£2,002.73

 Material
  Working Pressure
  Working Temp.
  Closed System
  Mounting Pos.
  Warranty
  Prices Ex. VAT



Scan for full technical specification
Valves and Accessories from page 90
See page 102 for clip-on accessories
compatibility

SD616W
White RAL 9016

£621.30^{+VAT}



SS1804C
Chrome

£393.91^{+VAT}



Sofi Vertical

Sheer confidence

A long, versatile radiator that will look at home in both modern and traditional surroundings. Unfussy design with elliptical tubes.



Scan for full technical specification

Valves and Accessories from page 90

See page 102 for clip-on accessories compatibility

Sofi Vertical

Finishes

PRODUCT	DIMENSIONS		HEAT OUTPUT ΔT 50 BTU	Finishes					
	Height mm	Length mm		White RAL 9016 W	Chrome C	Metallic Micrograin Black RAL 9005 B	Grey RAL 7015 GY	Other Solid RAL Colour R	Metallic Micrograin T
SS1504	1500	239	1503	£202.54	£361.65	£223.21	£223.21	£364.57	£401.03
SS1506	1500	357	2254	£278.30	£497.48	£306.69	£306.69	£500.93	£551.03
SS1804	1800	239	1803	£220.08	£393.91	£264.10		£396.15	£435.76
SS1806	1800	357	2705	£303.03	£578.98	£333.96		£545.46	£600.01
SS1809	1800	534	4057	£432.28	£787.82	£466.86		£778.10	£855.90
SS2004	2000	239	1605		£414.28				
SS2006	2000	357	2405		£609.54				
SD1505	1500	298	3108	£416.50		£449.82	£449.82	£749.70	£824.67
SD1507	1500	416	4351	£561.64		£606.57	£606.57	£1,010.96	£1,112.05
SD1805	1800	298	3706	£444.90		£480.49	£480.49	£800.81	£880.89
SD1807	1800	416	5188	£586.88		£633.84	£633.84	£1,056.39	£1,162.03
SD1809	1800	534	6671	£750.96		£811.04	£811.04	£1,351.73	£1,486.90
SD2005	2000	298	4338	£466.98		£504.34	£504.34	£840.57	£924.63
SD2007	2000	416	6073	£637.37		£688.36	£688.36	£1,147.26	£1,261.99
SD2009	2000	534	7808	£807.75		£872.38	£872.38	£1,453.96	£1,599.35

MS Material
 6 Working Pressure
 95°C Working Temp.
 C Closed System
 V Mounting Pos.
 5 YEARS Warranty
 £ Prices Ex. VAT



SD1805GY
Grey RAL 7015
£480.49
^{+VAT}



ND1505W
White RAL 9016
£463.10^{+VAT}
Price excludes valves

UDW927
Thermostatic Valve
£157.95^{+VAT}

Tian

Timeless elegance

Modern design meets timeless elegance in this versatile radiator with an unusual design and high heat output.

The Tian comes in white or grey with the choice of any RAL colour or metallic paint finish for full customisation.

Choose from a full range of sizes and enjoy five years' warranty for complete peace of mind.

Tian	Finishes						
	DIMENSIONS		HEAT OUTPUT	White	Grey	Other Solid	Metallic
	Height mm	Length mm		RAL 9016 W	RAL 7015 GY	RAL Colour R	Micrograin T
			ΔT 50 BTU				
NS1505	1500	390	1803	£297.80		£506.26	£556.88
NS1507	1500	544	2524	£391.40		£665.37	£731.91
NS1804	1800	313	1731	£279.22	£298.76	£474.67	£522.13
NS1805	1800	390	2162	£332.39	£355.67	£565.07	£621.58
NS1806	1800	467	2595	£385.10	£412.06	£654.67	£720.14
NS1807	1800	544	3029	£437.55	£468.18	£743.84	£818.22
NS2004	2000	313	1919	£298.31	£319.19	£507.14	£557.85
ND1504	1500	313	2595		£419.92		
ND1505	1500	390	3244	£463.10	£495.52	£787.27	£866.00
ND1804	1800	313	3114	£434.97	£465.42	£739.45	£813.39
ND1805	1800	390	3893	£526.18	£563.01	£894.51	£983.96
ND1806	1800	467	4672	£617.52	£660.75	£1,049.78	£1,154.75
ND1807	1800	544	5450	£708.85	£758.47	£1,205.05	£1,325.55
ND2004	2000	313	3456	£482.54		£820.31	£902.34
ND2005	2000	390	4320	£586.90		£997.73	£1,097.50
ND2006	2000	467	5184	£691.47	£739.87	£1,175.50	£1,293.05



Scan for full technical specification

Valves and Accessories from page 90



ND1804GY
Grey RAL 7015

£465.42
+VAT

MS 3.5 95°C C V 5 YEARS £
 Material Working Pressure Working Temp. Closed System Mounting Pos. Warranty Prices Ex. VAT



TS1806W
White RAL 9016
£301.33^{+VAT}

Tilbrook

Spacial economy

Can't choose between stunning design and reassuringly efficient heating? Why not have both with this stand-out vertical model?

Tilbrook PRODUCT	DIMENSIONS		HEAT OUTPUT ΔT 50 BTU	Finishes		
	Height mm	Length mm		White RAL 9016 W	Other Solid RAL Colour R	Metallic Micrograin T
TS1504	1500	106	1148	£211.40	£359.39	£395.33
TS1506	1500	156	1721	£269.78	£458.62	£504.48
TS1508	1500	206	2295	£336.04	£571.27	£628.39
TS1510	1500	256	2869	£425.96	£724.14	£796.55
TS1512	1500	306	3443	£506.42	£860.92	£947.01
TS1514	1500	356	4017	£586.88	£997.70	£1,097.47
TS1516	1500	406	4591	£668.92	£1,137.17	£1,250.88
TS1518	1500	456	5164	£725.72	£1,233.72	£1,357.09
TS1520	1500	506	5738	£780.93	£1,327.59	£1,460.35
TS1804	1800	106	1407	£239.80	£407.66	£448.43
TS1806	1800	156	2111	£301.33	£512.26	£563.49
TS1808	1800	206	2814	£394.41	£670.50	£737.55
TS1810	1800	256	3518	£465.41	£791.19	£870.31
TS1812	1800	306	4222	£556.91	£946.75	£1,041.42
TS1814	1800	356	4925	£642.10	£1,091.57	£1,200.73
TS1816	1800	406	5629	£730.45	£1,241.77	£1,365.94
TS1818	1800	456	6333	£818.80	£1,391.96	£1,531.15
TS1820	1800	506	7036	£907.15	£1,542.15	£1,696.36
TS2006	2000	156	2254	£321.84	£547.13	£601.84
TS2008	2000	206	3006	£407.03	£691.96	£761.15
TS2010	2000	256	3757	£503.27	£855.56	£941.11
TS2012	2000	306	4509	£597.93	£1,016.48	£1,118.13
TS2014	2000	356	5260	£694.16	£1,180.08	£1,298.09
TS2016	2000	406	6011	£790.40	£1,343.68	£1,478.05
TS2018	2000	456	6763	£886.64	£1,507.28	£1,658.01
TS2020	2000	506	7514	£981.30	£1,668.20	£1,835.02



Scan for full technical specification

Valves and Accessories from page 90

See page 102 for clip-on accessories



TS1806W
White RAL 9016

£301.33
+VAT

MS Material Working Pressure 6 Working Temp. 95°C Closed System C Mounting Pos. V 5 YEARS Warranty Prices Ex. VAT £

TR4T18C
Chrome
£725.37 +VAT

Trojan

Create a comfort zone

This ultra-modern, svelte radiator combines unforgettable design credentials with unmistakable, top-quality heat performance. Will look amazing anywhere.



Scan for full technical specification

Valves and Accessories from page 90

Trojan			Finishes		
PRODUCT	DIMENSIONS		HEAT OUTPUT	Chrome	Metallic Micrograin
	Height mm	Length mm		ΔT 50 BTU	Black RAL 9005 B
TR4T13	1300	390	3815	£564.72	£358.63
TR4T18	1760	390	5163	£725.37	£436.52
TRTH	Towel Hooks			£21.10	£16.23

MS	6	95°C	C	V	5 YEARS	£
Material	Working Pressure	Working Temperature	Closed System	Mounting Position	Warranty	Prices Ex. VAT



CYL850MC
Manual Valve
£40.49 +VAT

CYH850TC
Thermostatic Valve
£57.80 +VAT



TR4T13B
Metallic Micrograin
Black RAL 9005

£358.63
+VAT

Panel Radiators

Panel radiators have enduring appeal and excellent heat output – a winning combination in anyone’s book. We invite you to browse the Ultraheat collection of panel radiators to see for yourself the versatile choice and impressive specs that our products all have to offer.

Compact 4	42
New Panel Radiators	44
Lanner Horizontal	46
Lanner Vertical	47
LSOrad	48
Planal Horizontal	50
Planal Vertical	51
Sovran Horizontal	52
Sovran Vertical	53
Hypo (Heat Exchange Convector)	54



The largest range of in-stock steel panel radiators in the UK

400+ different items available for immediate delivery

10-year guarantee



Compact 4

The professionals' choice

Durable and versatile, Compact 4 offers a range of cost-effective, rapid heating solutions for homes and working environments.

- Perfect combination of efficient heating, reliability, quality and value
- Easy-fit, high efficiency radiators - with a wide choice of sizes and shapes to suit any room at home or in the workplace
- Quick and simple and inexpensive to fit
- The most popular choice of heating solution amongst professional fitters of domestic radiators
- UK's largest range of "in stock" steel panel radiators
- Each radiator is individually tested and supplied complete with a 10-year guarantee against any defects as a result of a manufacturing or a material fault.



Compact 4 DF

Double Panel
Double Convector
4 connections
(67mm deep)

Anthracite RAL 7016
mild steel radiators
available in 24 size options

- All radiators are pressure tested at 13 Bars before despatch to guarantee a working pressure of 10 Bars.
- Heights: 200, 300, 400, 500, 600, 700 & 900mm
- Lengths: 200, 300, 400, 500, 600, 700, 800, 900, 1000, 1100, 1200, 1300, 1400, 1600, 1800, 2000, 2200, 2400, 2700 & 3000mm



Material



Working Pressure



Warranty



Scan to request the
Ultraheat Compact 4 catalogue

Ultraheat Compact 4 radiators are available in four types:



Scan for prices and full technical specification

Compact 4 SF
 Single Panel Single Convector
 4 connections (52mm deep)
 White RAL 9016 mild steel radiators available in 116 size options



Scan for prices and full technical specification

Compact 4 DF
 Double Panel Double Convector
 4 connections (100mm deep)
 White RAL 9016 mild steel radiators available in 118 size options



Scan for prices and full technical specification

Compact 4 HF
 Double Panel Single Convector
 4 connections (67mm deep)
 White RAL 9016 mild steel radiators available in 84 size options



Scan for prices and full technical specification

Compact 4 TS
 Triple Panel Triple Convector
 6 connections (160mm deep)
 White RAL 9016 mild steel radiators available in 94 size options

Valves and Accessories from page 90



Lanner Horizontal LDS

Smooth and stylish double panel radiator with subtle lines
6 connections (50mm pipe centres)
4LDS1000

White RAL 9016 mild steel radiators
available in 30 size options

New additions to the Ultraheat convector panel radiator range

Ultraheat panel radiators have been the professionals' choice for over 30 years. It is a comprehensive range of durable radiators in Compact 4, Planal and Lanner models.

This range now extends to quadruple panel, single convector with six connections, the Compact 6 QS, the Planal PQS and the Lanner LQS.

Ultraheat is proud to have set the standard:

- The first 900mm high radiators in the country
- The first 200mm high radiators
- The first six tap, the Compact 6
- The first triple radiator
- Now the first quadruple radiator

These quadruple radiators (Q) solve the output challenge for 40°C to 50°C input. They work on a low temperature input from environmental, solar, thermal heat pumps and maximise the output. They are the ideal product for heat emission and are available as low and deep models.

Types available are:

- Compact 4 and Compact 6: SF HF DF DS QS
- Lanner: LSS LHS LDS LTS LQS LQS-T
- Planal: PSS PHS PDS PTS PQS PQS-T

The double-sided options (-T) are available for rooms with full-height windows.

Quadruple panel radiators (Q) are floor mounted only.

Please refer to Compact 4/6, Planal and Lanner catalogue for full details.

MS

10

10 YEARS

Material Working Pressure Warranty

Ultraheat panel radiators are available in numerous models, including:



Compact 6 QS

Quadruple Panel Single Convactor
6 connections (50mm pipe centres)
2QS1000

White RAL 9016 mild steel radiators
available in 18 size options



Lanner Horizontal LQS

Smooth and stylish quadruple
panel radiator
6 connections (50mm pipe centres)
2LQS1000

White RAL 9016 mild steel radiators
available in 18 size options



Lanner Horizontal LDS

Smooth and stylish double
panel radiator with subtle lines
6 connections (50mm pipe centres)
5LDS1000

White RAL 9016 mild steel radiators
available in 30 size options



Planal Horizontal PDS

Double Panel Single Convactor
4 connections (50mm pipe centres)
5PDS1000

White RAL 9016 mild steel radiators
available in 200 size options



Lanner

Contemporary panels

Ideal for open-plan home styling, Lanner radiators offer the option of tall, vertical panels, as well as a large range of horizontal sizes and finishes.

They are powerful, reliable and highly versatile, with subtle lines across the radiator.

A choice of finishes

- White RAL 9016
- Any RAL Colour
- Any Metallic Finish



Scan to request the
Ultraheat Planal & Lanner catalogue

Lanner Horizontal

Minimalism in a radiator; the smooth, stylish panel offers understated elegance. Available in a range of sizes as single, double and triple panel radiators to fit all installations.

- **Height:** 200mm - 900mm
- **Length:** 400mm - 2400mm
- **Depth:** 52mm - 164mm



Scan for prices and full technical specification

Valves and Accessories from page 90

Lanner Vertical

This eye-catching radiator will turn heads and heat both period and contemporary homes. The perfect partner for open-plan living. Available in a range of sizes as single and double panel radiators to fit all installations.

- **Height:** 1200mm - 2000mm
- **Length:** 200mm - 900mm
- **Depth:** 52mm - 104mm



Scan for prices and full technical specification

Valves and Accessories from page 90

     
 Material Working Pressure Working Temp. Closed System Mounting Pos. Warranty





RTAVW
Thermostatic Valve
£204.21^{+VAT}

LSO6D10W
White RAL 9016
£730.05^{+VAT}





LSO6D07W
White RAL 9016
£613.49^{+VAT}

LSOrad

One-piece radiator casing

This practical model combines excellent heat output (from a Compact 4 radiator) with safety, flexibility and a classically timeless design. Ideal for special projects.

LSOrad Type D				Finish 
PRODUCT	CASING DIMENSIONS		CASING + RAD HEAT OUTPUT	
	Height mm	Length mm	ΔT 50 BTU	White RAL 9016 W
LSO5D07	700	700	2545	£637.77
LSO5D10	700	1000	4069	£799.50
LSO5D12	700	1200	5087	£929.97
LSO5D14	700	1400	6105	£1,062.07
LSO5D16	700	1600	7122	£1,187.21
LSO5D18	700	1800	8137	£1,238.58
LSO5D20	700	2000	9155	£1,296.82
LSO5D22	700	2200	10173	£1,433.63
LSO6D07	800	700	2938	£697.59
LSO6D10	800	1000	4697	£961.07
LSO6D12	800	1200	5872	£1,015.45
LSO6D14	800	1400	7047	£1,099.45
LSO6D16	800	1600	8222	£1,235.47
LSO6D18	800	1800	9394	£1,321.90
LSO6D20	800	2000	10569	£1,390.38
LSO6D22	800	2200	11744	£1,530.72
LSO7D07	900	700	3299	£808.32
LSO7D10	900	1000	5278	£961.91
LSO7D12	900	1200	6598	£1,110.81
LSO7D14	900	1400	7917	£1,187.10
LSO7D16	900	1600	9237	£1,371.74
LSO7D18	900	1800	10556	£1,438.96
LSO7D20	900	2000	11876	£1,535.05
LSO7D22	900	2200	13196	£1,693.77
RTAVW	Close Coupled TRV with W/H & L/S Valves & 2m Capillary Tube			£204.21

LSOrad Type H				Finish 
PRODUCT	CASING DIMENSIONS		CASING + RAD HEAT OUTPUT	
	Height mm	Length mm	ΔT 50 BTU	White RAL 9016 W
LSO5H07	700	700	1976	£632.12
LSO5H10	700	1000	3161	£780.12
LSO5H12	700	1200	3949	£911.01
LSO5H14	700	1400	4738	£1,041.69
LSO5H16	700	1600	5530	£1,078.55
LSO5H18	700	1800	6318	£1,209.54
LSO5H20	700	2000	7110	£1,265.72
LSO5H22	700	2200	7898	£1,317.25
LSO6H07	800	700	2290	£689.57
LSO6H10	800	1000	3663	£856.36
LSO6H12	800	1200	4578	£986.52
LSO6H14	800	1400	5492	£1,073.69
LSO6H16	800	1600	6409	£1,142.59
LSO6H18	800	1800	7324	£1,279.24
LSO6H20	800	2000	8241	£1,338.69
LSO6H22	800	2200	9155	£1,396.98
LSO7H07	900	700	2589	£792.05
LSO7H10	900	1000	4141	£932.92
LSO7H12	900	1200	5175	£993.43
LSO7H14	900	1400	6208	£1,153.94
LSO7H16	900	1600	7245	£1,239.27
LSO7H18	900	1800	8279	£1,391.07
LSO7H20	900	2000	9315	£1,481.78
RTAVW	Close Coupled TRV with W/H & L/S Valves & 2m Capillary Tube			£204.21



Scan for full technical specification

Valves and Accessories from page 90

 Material
  Working Pressure
  Working Temp.
  Closed System
  Mounting Pos.
  Warranty
  Prices Ex. VAT



6PDS900W
 White RAL 9016

£551.89^{+VAT}

UDW927
 Thermostatic Valve
£157.95^{+VAT}

TWU850TW
 Thermostatic Valve
£127.33^{+VAT}

VHS-str
 Thermostatic Valve
£161.60^{+VAT}



Planal

Smooth heating

The ultimate, flat-fronted radiators have a minimalist style, ideal for your modern living room, bedroom or office. Planal radiators offer the option of tall, vertical panels, as well as a large range of horizontal sizes and finishes.

A choice of finishes

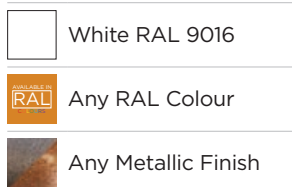

Scan to request the
 Ultraheat Planal & Lanner catalogue

Planal Horizontal

Smooth and seamless, this discreet, minimalist design will look the part in any bedroom, kitchen or hallway. Available in a range of sizes as single, double and triple panel radiators to fit all installations.

- **Height:** 200mm - 900mm
- **Length:** 400mm - 2400mm
- **Depth:** 52mm - 164mm



Scan for prices and full technical specification

Valves and Accessories from page 90

Planal Vertical

Attention-grabbing modern design and excellent heat performance. What more do you need in a radiator? Available in a range of sizes as single and double panel radiators to fit all installations.

- **Height:** 1200mm - 2000mm
- **Length:** 200mm - 900mm
- **Depth:** 52mm - 104mm



Scan for prices and full technical specification

Valves and Accessories from page 90



Material



Working Pressure



Working Temp.



Closed System



Mounting Pos.



Warranty

16VPH500W
White RAL 9016

£860.45^{+VAT}

CYH850TW
Thermostatic Valve
£70.66^{+VAT}





UDS927
Thermostatic Valve
£181.20^{+VAT}

SOVD605HS
Brushed Matt

TWU850TS
Thermostatic Valve
£127.23^{+VAT}

£523.98^{+VAT}

Sovran Horizontal

High heat output

This mild steel panel radiator has a stainless steel cover and a minimalist, modern style with just a hint of fun. Go for something different!



Scan for full technical specification

Valves and Accessories from page 90

Sovran Horizontal

DISCONTINUED - Available while stocks last

PRODUCT	DIMENSIONS		HEAT OUTPUT	Finish
	Height mm	Length mm		
SOVD608h	605	805	ΔT 50 BTU 4655	Brushed Matt S £523.98

SS
Material

10
Working Pressure

120°C
Working Temperature

O C
Open/Closed System

V
Mounting Position

5 YEARS
Warranty

£
Prices Ex. VAT



SOVD605HS
Brushed Matt
£523.98
^{+VAT}



SOVD186VS
Brushed Matt
£996.41
+VAT

P926
H Valve
£40.55+VAT

UDS927
Thermostatic Valve
£181.20+VAT

TWU850TS
Thermostatic Valve
£127.23+VAT



SOVS186VS
Brushed Matt
£928.02
+VAT

Sovran Vertical

Visual delight

Worthy of any feature wall, this towering design turns a practical heating source into a crowd-pleasing piece of art. It is a mild steel radiator with a stainless steel cover.

Sovran Vertical
DISCONTINUED - Available while stocks last

PRODUCT	DIMENSIONS		HEAT OUTPUT	Finish
	Height mm	Length mm		
SOVD167v	1605	705	5772	Brushed Matt S £1,055.33 £996.41 £1,152.13 £728.10 £822.80 £952.22 £1,077.43 £928.02 £860.88 £996.41
SOVD186v	1805	605	5505	
SOVD187v	1805	705	6300	
SOVD203v	2005	305	3231	
SOVD204v	2005	405	4162	
SOVD205v	2005	505	5064	
SOVD206v	2005	605	5947	
SOVS186v	1805	605	2615	
SOVS205v	2005	505	2803	
SOVS206v	2005	605	3273	



Scan for full technical specification

Valves and Accessories from page 90

- Material
- Working Pressure
- Working Temperature
- Open/Closed System
- Mounting Position
- Warranty
- Prices Ex. VAT



HP212W
White RAL 9016

£1,045.08^{+VAT}

Hypo

Heat Exchange Convector

Reduced water and lower energy usage are just two of the many benefits of this efficient, low-slung panel radiator.



HP212W
White RAL 9016
£1,045.08
^{+VAT}



Scan for full technical specification

Valves and Accessories from page 90

PRODUCT	DIMENSIONS		HEAT OUTPUT	Finishes	
	Height mm	Length mm		White RAL 9016 W	Any RAL Colour R
HP208	200	800	1485	£795.14	£914.41
HP209	200	900	1670	£845.10	£971.87
HP210	200	1000	1855	£894.15	£1,028.27
HP211	200	1100	2042	£952.75	£1,095.66
HP212	200	1200	2227	£1,045.08	£1,201.84
HP214	200	1400	2599	£1,130.03	£1,299.54
HP216	200	1600	2969	£1,242.60	£1,428.99
HP218	200	1800	3340	£1,340.48	£1,541.55
HP220	200	2000	3712	£1,431.69	£1,646.44

MS Material
 6 Working Pressure
 95°C Working Temp.
 C Closed System
 H Mounting Pos.
 5 YEARS Warranty
 £ Prices Ex. VAT

Aluminium Radiators

Lightweight, durable and attractive, aluminium is the ideal material for producing radiators and heated towel rails that perform at every level. Top quality performance adds dependable warmth and comfort to the home or office.

Argus	56
Banio	58
Bombe	60
Diana	62
Heran	63
Hestia	64
Kavis	66
Kupka	68
Kural	70
Luvre	72
Mira	74
Plateau	75
Porte	76
Smyrna	78
Virtu	80
Visage	82



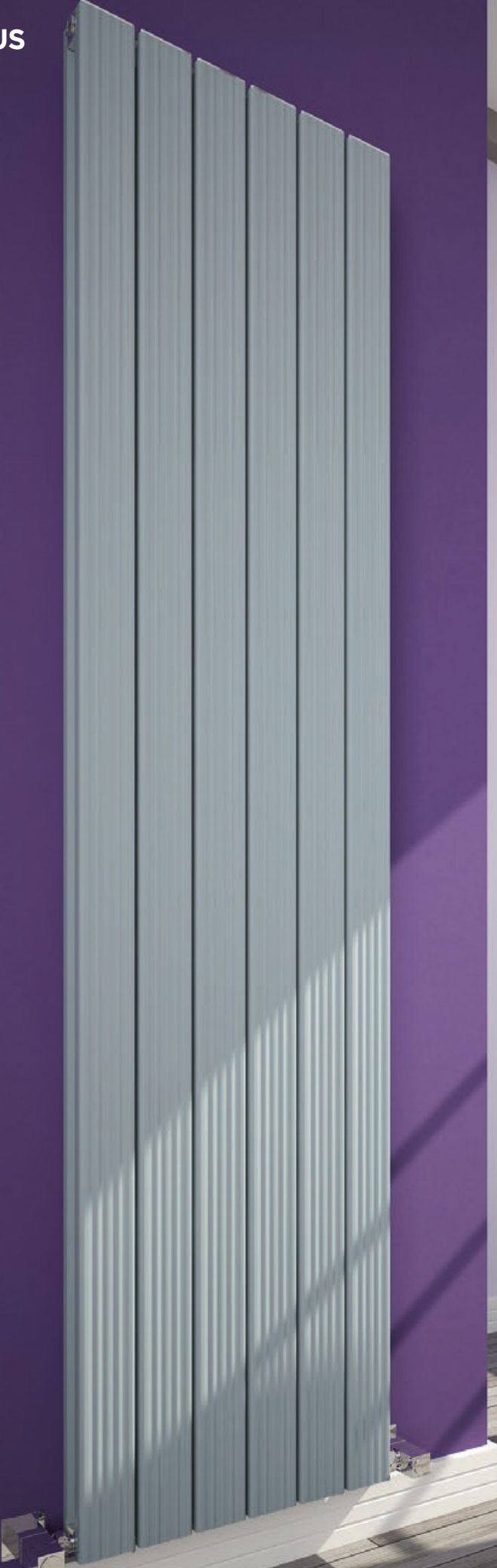

Window Grey RAL 7040
Image for illustration purposes

CUH840MC
Manual Valve
£192.40^{+VAT}

CUH850MC
Manual Valve
£102.35^{+VAT}

CUH853MC
Manual Valve
£90.43^{+VAT}



ARG0614AO
Other Anodised
Black RAL 9005
£1,090.72 +VAT

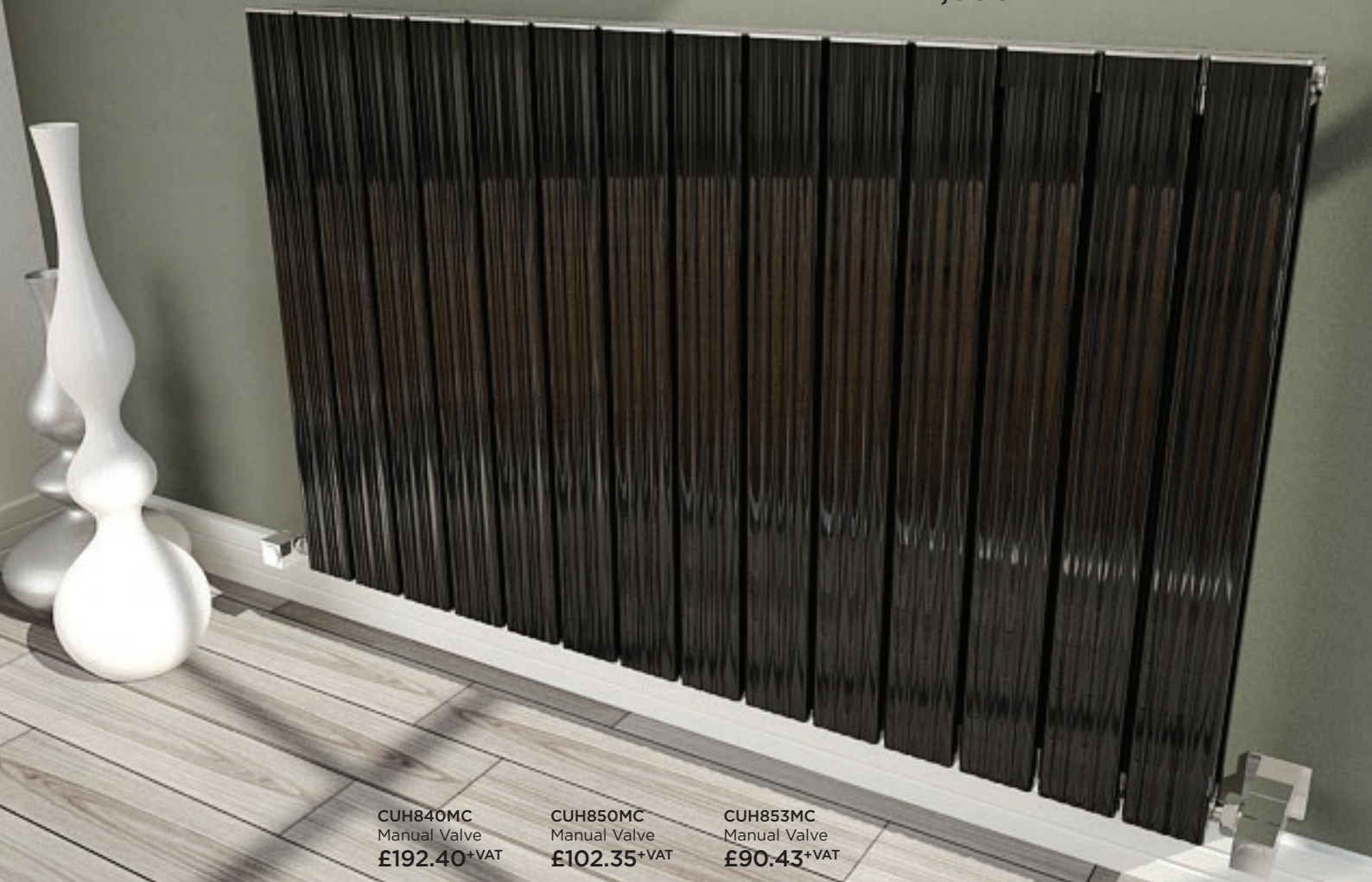

CUH840MC
Manual Valve
£192.40 +VAT

CUH850MC
Manual Valve
£102.35 +VAT

CUH853MC
Manual Valve
£90.43 +VAT

Argus

In the groove

Scan for full technical specification
Valves and Accessories from page 90



If industrial chic is your thing, then you will love this sleek design with its unusually striking, shallow, vertical grooves.

Argus				Finishes								
PRODUCT	DIMENSIONS		HEAT OUTPUT	White	RAL	Matt	Gloss	Dupont	Any	Other	Wood	Crocodile
	Height mm	Length mm		White RAL 9010 W	9016 / 9001 / 1013 OW	Anodised MA	Anodised GA	Micrograin DX	Any RAL Colour RAL	Anodised AO	Effect WE	Textured CR
			ΔT 50 BTU									
ARG0608	600	555	3091	£468.28	£491.69	£491.69	£538.52	£533.84	£585.35	£632.18	£632.18	£655.59
ARG0610	600	695	3863	£583.69	£612.88	£612.88	£671.25	£665.41	£729.62	£787.99	£787.99	£817.17
ARG0612	600	835	4638	£692.53	£727.15	£727.15	£796.40	£789.48	£865.66	£934.91	£934.91	£969.54
ARG0614	600	975	5410	£807.94	£848.34	£848.34	£929.13	£921.05	£1,009.92	£1,090.72	£1,090.72	£1,131.11
ARG0616	600	1115	6182	£910.17	£955.68	£955.68	£1,046.70	£1,037.60	£1,137.72	£1,228.73	£1,228.73	£1,274.24
ARG1804	1800	275	3573	£532.58	£559.21	£559.21	£612.46	£607.14	£665.72	£718.98	£718.98	£745.61
ARG1805	1800	345	4464	£664.50	£697.72	£697.72	£764.17	£757.53	£830.62	£897.07	£897.07	£930.30
ARG1807	1800	485	6251	£918.41	£964.33	£964.33	£1,056.17	£1,046.99	£1,148.02	£1,239.86	£1,239.86	£1,285.78

AL Material
 10 Working Pressure
 95°C Working Temp.
 C Closed System
 V Mounting Pos.
 10 YEARS Warranty
 £ Prices Ex. VAT



BN515W
White RAL 9010
£651.41
+VAT

UDW850
Thermostatic Valve
£63.65+VAT

CYH850TW
Thermostatic Valve
£70.66+VAT



BN510W
White RAL 9010
£463.67
+VAT

CYH850MC
Manual Valve
£47.30+VAT

CYL850MC
Manual Valve
£40.49+VAT

Banio

Beautifully engineered

A stunning towel rail with an elegant, versatile design and practical, expansive storage space.



Scan for full technical specification

Valves and Accessories from page 90

See page 102 for clip-on accessories compatibility

Banio			Finishes									
PRODUCT	DIMENSIONS		HEAT OUTPUT	White	AVAILABLE IN RAL	Matt	Gloss	Dupont	Any	Other	Wood	Crocodile
	Height mm	Length mm		White RAL 9010 W	9016 / 9001 / 1013 OW	Anodised MA	Anodised GA	Micrograin DX	Any RAL Colour RAL	Anodised AO	Effect WE	Textured CR
BN407	700	425	1489	£285.58	£299.86	£299.86	£328.42	£325.57	£356.98	£385.54	£385.54	£399.82
BN410	1000	425	1888	£431.99	£453.59	£453.59	£496.79	£492.47	£539.99	£583.18	£583.18	£604.78
BN415	1500	425	2315	£600.19	£630.20	£630.20	£690.22	£684.21	£750.24	£810.25	£810.25	£840.26
BN417	1700	425	2391	£699.11	£734.07	£734.07	£803.98	£796.99	£873.89	£943.80	£943.80	£978.76
BN507	700	525	1752	£315.27	£331.03	£331.03	£362.56	£359.40	£394.08	£425.61	£425.61	£441.37
BN510	1000	525	2206	£463.67	£486.85	£486.85	£533.22	£528.58	£579.59	£625.95	£625.95	£649.14
BN515	1500	525	2677	£651.41	£683.98	£683.98	£749.12	£742.61	£814.26	£879.41	£879.41	£911.98
BN517	1700	525	2790	£755.18	£792.94	£792.94	£868.46	£860.91	£943.98	£1,019.49	£1,019.49	£1,057.25

AL Material
 10 Working Pressure
 95°C Working Temp.
 C Closed System
 V Mounting Pos.
 10 YEARS Warranty
 £ Prices Ex. VAT



Matt Anodised
Image for illustration purposes

UDW850
Thermostatic Valve
£63.65+VAT

CYH850TW
Thermostatic Valve
£70.66+VAT

BLU607W
White RAL 9010
£482.21
+VAT

Bombe

Convex curves

Sumptuous, convex curves shimmer as the light plays and bounces across the surface of this graceful, tactile radiator.



Scan for full technical specification

Valves and Accessories from page 90



Bombe			Finishes									
PRODUCT	DIMENSIONS		HEAT OUTPUT ΔT 50 BTU									
	Height mm	Length mm		White RAL 9010 W	RAL 9016 / 9001 / 1013 OW	Matt Anodised MA	Gloss Anodised GA	Dupont Micrograin DX	Any RAL Colour RAL	Other Anodised AO	Wood Effect WE	Crocodile Textured CR
BLU607	600	485	2104	£482.21	£506.32	£506.32	£554.54	£549.72	£602.76	£650.99	£650.99	£675.10
BLU609	600	625	2705	£606.38	£636.70	£636.70	£697.34	£691.28	£757.98	£818.62	£818.62	£848.94
BLU611	600	765	3306	£742.47	£779.59	£779.59	£853.84	£846.41	£928.08	£1,002.33	£1,002.33	£1,039.45
BLU613	600	905	3907	£877.89	£921.78	£921.78	£1,009.57	£1,000.79	£1,097.36	£1,185.15	£1,185.15	£1,229.04
BLU614	600	975	4207	£943.29	£990.45	£990.45	£1,084.78	£1,075.35	£1,179.11	£1,273.44	£1,273.44	£1,320.61
BLU615	600	1045	4508	£1,010.65	£1,061.18	£1,061.18	£1,162.25	£1,152.14	£1,263.31	£1,364.38	£1,364.38	£1,414.91
BLU618	600	1255	5409	£1,211.12	£1,271.68	£1,271.68	£1,392.79	£1,380.68	£1,513.90	£1,635.01	£1,635.01	£1,695.57
BLU621	600	1465	6311	£1,416.24	£1,487.05	£1,487.05	£1,628.67	£1,614.51	£1,770.30	£1,911.92	£1,911.92	£1,982.73
BLU625	600	1745	7513	£1,681.79	£1,765.87	£1,765.87	£1,934.05	£1,917.24	£2,102.23	£2,270.41	£2,270.41	£2,354.50
BLU628	600	1955	8415	£1,885.92	£1,980.21	£1,980.21	£2,168.81	£2,149.95	£2,357.40	£2,545.99	£2,545.99	£2,640.28
BLU1505	1500	345	3087	£689.64	£724.12	£724.12	£793.08	£786.19	£862.05	£931.01	£931.01	£965.49
BLU1507	1500	485	4320	£961.13	£1,009.19	£1,009.19	£1,105.30	£1,095.69	£1,201.41	£1,297.52	£1,297.52	£1,345.58
BLU1509	1500	625	5553	£1,237.90	£1,299.79	£1,299.79	£1,423.58	£1,411.21	£1,547.37	£1,671.16	£1,671.16	£1,733.06
BLU1510	1500	695	6171	£1,373.31	£1,441.97	£1,441.97	£1,579.30	£1,565.57	£1,716.63	£1,853.96	£1,853.96	£1,922.63
BLU1803	1800	205	2418	£502.68	£527.82	£527.82	£578.09	£573.06	£628.36	£678.62	£678.62	£703.76
BLU1804	1800	275	3224	£657.92	£690.81	£690.81	£756.60	£750.02	£822.40	£888.19	£888.19	£921.08
BLU1805	1800	345	4030	£825.05	£866.30	£866.30	£948.80	£940.55	£1,031.31	£1,113.81	£1,113.81	£1,155.06
BLU1806	1800	415	4836	£986.88	£1,036.23	£1,036.23	£1,134.91	£1,125.04	£1,233.60	£1,332.29	£1,332.29	£1,381.63
BLU1807	1800	485	5642	£1,154.00	£1,211.70	£1,211.70	£1,327.10	£1,315.56	£1,442.50	£1,557.90	£1,557.90	£1,615.60
BLU1809	1800	625	7253	£1,482.96	£1,557.11	£1,557.11	£1,705.41	£1,690.58	£1,853.70	£2,002.00	£2,002.00	£2,076.15
BLU2005	2000	345	4559	£908.93	£954.38	£954.38	£1,045.27	£1,036.19	£1,136.17	£1,227.06	£1,227.06	£1,272.51
BLU2007	2000	485	6383	£1,268.93	£1,332.38	£1,332.38	£1,459.27	£1,446.58	£1,586.16	£1,713.06	£1,713.06	£1,776.50
BLU2009	2000	625	8206	£1,628.94	£1,710.39	£1,710.39	£1,873.28	£1,857.00	£2,036.18	£2,199.07	£2,199.07	£2,280.52

Material
 Working Pressure
 Working Temp.
 Closed System
 Mounting Pos.
 Warranty
 Prices Ex. VAT



Matt Anodised
Image for illustration purposes

DN105W
White RAL 9010
£253.68
+VAT



CYL850MC
Manual Valve
£40.49+VAT

Diana

Slim and sleek

Heating fit for a goddess. This dramatic design holds a pleasingly large number of towels, while remaining practical and lightweight.

Scan for full technical specification

Valves and Accessories from page 90

See page 102 for clip-on accessories compatibility



Diana				Finishes								
PRODUCT	DIMENSIONS		HEAT OUTPUT ΔT 50 BTU									
	Height mm	Length mm		White RAL 9010 W	RAL 9016 / 9001 / 1013 OW	Matt Anodised MA	Gloss Anodised GA	Dupont Micrograin DX	Any RAL Colour RAL	Other Anodised AO	Wood Effect WE	Crocodile Textured CR
DN075	690	525	1076	£201.88	£211.97	£211.97	£232.16	£230.14	£252.35	£272.54	£272.54	£282.63
DN105	920	525	1383	£253.68	£266.36	£266.36	£291.73	£289.19	£317.10	£342.47	£342.47	£355.15
DN125	1150	525	1690	£303.71	£318.89	£318.89	£349.26	£346.22	£379.63	£410.00	£410.00	£425.19
DN076	690	625	1291	£217.96	£228.86	£228.86	£250.65	£248.47	£272.45	£294.24	£294.24	£305.14
DN106	920	625	1660	£269.76	£283.25	£283.25	£310.22	£307.52	£337.20	£364.17	£364.17	£377.66
DN126	1150	625	2029	£334.08	£350.78	£350.78	£384.19	£380.85	£417.60	£451.00	£451.00	£467.71



Material Working Pressure



Working Temp.



Closed System



Mounting Pos.



Warranty



Prices Ex. VAT

ULTRAHEAT

PREMIER RANGE

T: +44 (0)1908 010333 F: +44 (0)1908 640017 E: heating-sales@pitacs.com W: www.ultraheat.co.uk



HR412TMB
Matt Black RAL 9005

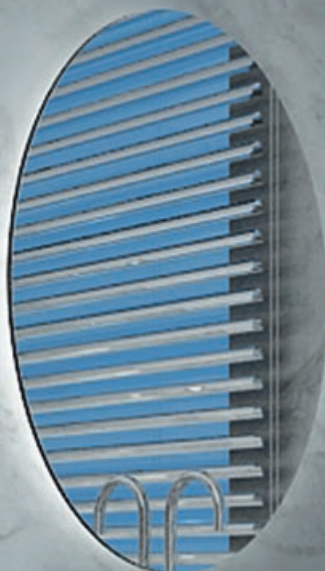

£618.01
+VAT



Heran

Simple and stylish

This model comes with a moveable towel bar for the last word in convenience and flexibility. One towel bar is included and additional bars are available to order separately.

Heran			Finishes			
PRODUCT	DIMENSIONS		HEAT OUTPUT			
	Height mm	Length mm		White RAL 9016 W	Matt Black RAL 9005 MB	Anthracite RAL 7016 AN
HR412T	1200	450	1476	£618.01	£618.01	£618.01
HR415T	1500	450	1844	£741.60	£741.60	£741.60
HR418T	1800	450	2213	£865.21	£865.21	£865.21
HR4T	50	380	Towel Rail	£67.16	£67.16	£67.16



Scan for full
technical specification

Valves and Accessories
from page 90



AVAILABLE AS FULLY
ELECTRIC READY

Scan for more on the
fully electric range

       
 Material Working Pressure Working Temp. Closed System Mounting Pos. Warranty Prices Ex. VAT



HES106MA
Matt Anodised

£425.79^{+VAT}

OSW300CL1-W
Oswest Smart Heating Element
£122.00^{+VAT}

STCN-1W
Stoke Control Box
£160.27^{+VAT}

ST400-1
Stoke Heating Element Rod
£46.55^{+VAT}



Hestia

Minimalism in action

The clean lines on this beautiful model will warm your soul as surely as it will heat up your towels.



Scan for full technical specification
Valves and Accessories from page 90
See page 102 for clip-on accessories compatibility

Hestia				Finishes								
PRODUCT	DIMENSIONS		HEAT OUTPUT ΔT 50 BTU W	White	RAL	Matt	Gloss	Dupont	Any	Other	Wood	Crocodile
	Height mm	Length mm		RAL 9010 W	9016 / 9001 / 1013 OW	Anodised MA	Anodised GA	Micrograin DX	RAL Colour RAL	Anodised AO	Effect WE	Textured CR
HES075	779	500	1127	£281.56	£295.64	£295.64	£323.79	£320.98	£351.95	£380.10	£380.10	£394.18
HES105	995	500	1503	£366.56	£384.89	£384.89	£421.54	£417.88	£458.20	£494.85	£494.85	£513.18
HES125	1288	500	1878	£451.56	£474.14	£474.14	£519.29	£514.78	£564.45	£609.61	£609.61	£632.18
HES165	1581	500	2254	£547.19	£574.55	£574.55	£629.27	£623.80	£683.99	£738.71	£738.71	£766.07
HES076	779	600	1352	£313.43	£329.11	£329.11	£360.45	£357.32	£391.79	£423.14	£423.14	£438.81
HES106	995	600	1803	£405.52	£425.79	£425.79	£466.35	£462.29	£506.90	£547.45	£547.45	£567.73
HES126	1288	600	2254	£501.15	£526.21	£526.21	£576.32	£571.31	£626.44	£676.55	£676.55	£701.61
HES166	1581	600	2705	£605.62	£635.90	£635.90	£696.47	£690.41	£757.03	£817.59	£817.59	£847.87

AL 10 95°C C V 10 YEARS £
 Material Working Pressure Working Temp. Closed System Mounting Pos. Warranty Prices Ex. VAT



HES125MA
Black Matt Anodised
£474.14
+VAT



KAV204-29MA
Matt Anodised

£1,477.62^{+VAT}

UDC850
Thermostatic Valve
£63.65^{+VAT}

CYL850MC
Manual Valve
£40.49^{+VAT}

CYH850TC
Thermostatic Valve
£57.80^{+VAT}

Metallic Micrograin Matt Gold in Crocodile Texture



Kavis

Venetian elegance

Dance the light fantastic with this elegant radiator that plays with light as it bounces off each individual bar.



Scan for full technical specification
Valves and Accessories from page 90

Kavis PRODUCT	DIMENSIONS		HEAT OUTPUT ΔT 50 BTU	Finishes								
	Height mm	Length mm		White RAL 9010 W	RAL 9016 / 9001 / 1013 OW	Matt Anodised MA	Gloss Anodised GA	Dupont Micrograin DX	Any RAL Colour RAL	Other Anodised AO	Wood Effect WE	Crocodile Textured CR
KAV405-6	415	450	1332	£316.56	£332.38	£332.38	£364.04	£360.87	£395.69	£427.35	£427.35	£443.18
KAV406-6	415	600	1783	£358.87	£376.81	£376.81	£412.70	£409.11	£448.58	£484.47	£484.47	£502.41
KAV408-6	415	825	2336	£452.89	£475.54	£475.54	£520.83	£516.30	£566.12	£611.41	£611.41	£634.05
KAV410-6	415	1000	2705	£499.91	£524.90	£524.90	£574.89	£569.89	£624.88	£674.87	£674.87	£699.87
KAV412-6	415	1250	3443	£565.72	£594.01	£594.01	£650.58	£644.93	£707.16	£763.73	£763.73	£792.01
KAV415-6	415	1500	4119	£639.38	£671.35	£671.35	£735.29	£728.89	£799.22	£863.16	£863.16	£895.13
KAV417-6	415	1750	4488	£744.37	£781.59	£781.59	£856.03	£848.59	£930.47	£1,004.91	£1,004.91	£1,042.12
KAV420-6	415	2000	4611	£818.03	£858.93	£858.93	£940.73	£932.55	£1,022.54	£1,104.34	£1,104.34	£1,145.24
KAV603-9	625	375	1691	£427.82	£449.21	£449.21	£491.99	£487.71	£534.77	£577.56	£577.56	£598.95
KAV604-9	625	450	1998	£463.86	£487.06	£487.06	£533.44	£528.80	£579.83	£626.21	£626.21	£649.41
KAV606-9	625	600	2674	£514.01	£539.71	£539.71	£591.11	£585.97	£642.51	£693.91	£693.91	£719.61
KAV607-9	625	750	3258	£579.83	£608.82	£608.82	£666.80	£661.00	£724.79	£782.77	£782.77	£811.76
KAV608-9	625	825	3504	£658.18	£691.09	£691.09	£756.91	£750.33	£822.73	£888.55	£888.55	£921.46
KAV610-9	625	1000	4058	£727.14	£763.49	£763.49	£836.21	£828.94	£908.92	£981.63	£981.63	£1,017.99
KAV612-9	625	1250	5164	£824.30	£865.51	£865.51	£947.94	£939.70	£1,030.37	£1,112.80	£1,112.80	£1,154.02
KAV615-9	625	1500	6179	£932.43	£979.05	£979.05	£1,072.29	£1,062.97	£1,165.53	£1,258.78	£1,258.78	£1,305.40
KAV617-9	625	1750	6732	£1,101.67	£1,156.76	£1,156.76	£1,266.93	£1,255.91	£1,377.09	£1,487.26	£1,487.26	£1,542.34
KAV620-9	625	2000	6917	£1,209.80	£1,270.29	£1,270.29	£1,391.27	£1,379.18	£1,512.26	£1,633.24	£1,633.24	£1,693.73
KAV154-22	1535	450	4884	£1,071.90	£1,125.49	£1,125.49	£1,232.68	£1,221.97	£1,339.87	£1,447.06	£1,447.06	£1,500.66
KAV156-22	1535	600	6537	£1,191.00	£1,250.55	£1,250.55	£1,369.65	£1,357.74	£1,488.75	£1,607.85	£1,607.85	£1,667.40
KAV183-26	1815	375	4884	£1,164.36	£1,222.58	£1,222.58	£1,339.01	£1,327.37	£1,455.45	£1,571.88	£1,571.88	£1,630.10
KAV184-26	1815	450	5772	£1,264.65	£1,327.89	£1,327.89	£1,454.35	£1,441.70	£1,580.82	£1,707.28	£1,707.28	£1,770.51
KAV186-26	1815	600	7726	£1,404.13	£1,474.33	£1,474.33	£1,614.74	£1,600.70	£1,755.16	£1,895.57	£1,895.57	£1,965.78
KAV187-26	1815	750	9413	£1,585.91	£1,665.20	£1,665.20	£1,823.80	£1,807.94	£1,982.39	£2,140.98	£2,140.98	£2,220.27
KAV203-29	2025	375	5448	£1,296.00	£1,360.79	£1,360.79	£1,490.39	£1,477.43	£1,619.99	£1,749.59	£1,749.59	£1,814.39
KAV204-29	2025	450	6438	£1,407.26	£1,477.62	£1,477.62	£1,618.35	£1,604.28	£1,759.07	£1,899.80	£1,899.80	£1,970.16
KAV206-29	2025	600	8618	£1,562.40	£1,640.52	£1,640.52	£1,796.76	£1,781.14	£1,953.00	£2,109.24	£2,109.24	£2,187.36

AL Material
 10 Working Pressure
 95°C Working Temp.
 C Closed System
 V Mounting Pos.
 10 YEARS Warranty
 £ Prices Ex. VAT



KP507W
White RAL 9010

£367.64^{+VAT}

Kupka

All-round performer

A graceful towel rail with lots of space to play with. Its rounded bars will enhance any room.

This versatile design comes in a broad range of finishes and sizes to fill available space.









Lightweight, practical design can be installed easily onto any wall for instant, welcoming warmth.



Scan for full technical specification

Valves and Accessories from page 90

See page 102 for clip-on accessories compatibility

Kupka				Finishes								
PRODUCT	DIMENSIONS		HEAT OUTPUT ΔT 50 BTU									
	Height mm	Length mm		White RAL 9010 W	RAL 9016 / 9001 / 1013 OW	Matt Anodised MA	Gloss Anodised GA	Dupont Micrograin DX	Any RAL Colour RAL	Other Anodised AO	Wood Effect WE	Crocodile Textured CR
KP407	720	425	1308	£327.99	£344.39	£344.39	£377.19	£373.91	£409.99	£442.79	£442.79	£459.19
KP410	1000	425	1772	£432.52	£454.15	£454.15	£497.40	£493.08	£540.65	£583.91	£583.91	£605.53
KP412	1200	425	1957	£502.81	£527.95	£527.95	£578.23	£573.20	£628.51	£678.79	£678.79	£703.94
KP416	1600	425	2158	£674.01	£707.71	£707.71	£775.11	£768.37	£842.51	£909.91	£909.91	£943.61
KP507	700	525	1537	£367.64	£386.03	£386.03	£422.79	£419.11	£459.55	£496.32	£496.32	£514.70
KP510	1000	525	2087	£472.17	£495.78	£495.78	£543.00	£538.28	£590.22	£637.43	£637.43	£661.04
KP512	1200	525	2312	£544.25	£571.46	£571.46	£625.89	£620.44	£680.31	£734.74	£734.74	£761.95
KP516	1600	525	2537	£719.07	£755.02	£755.02	£826.93	£819.73	£898.83	£970.74	£970.74	£1,006.69

 Material
  Working Pressure
  Working Temp.
  Closed System
  Mounting Pos.
  Warranty
  Prices Ex. VAT

Kural

Tactile aluminium tubes

A strong, tubular look leads the eye directly to this distinguished statement piece. Sleek, undeniable sophistication for any space.

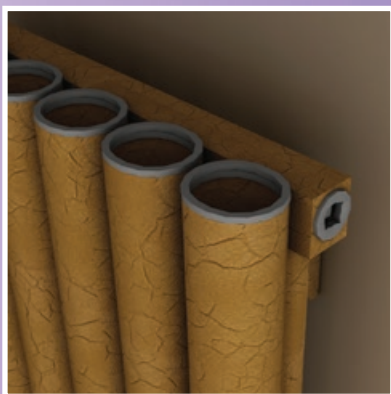

Crocodile Textured



KUR1812MA
Matt Anodised

£1,621.26^{+VAT}

CYL850MC
Manual Valve
£40.49^{+VAT}

CYH850TC
Thermostatic Valve
£57.80^{+VAT}





Scan for full technical specification

Valves and Accessories from page 90

The tactile feel of the long, aluminium tubes make this striking radiator appeal to the senses in more ways than one.

Excellent heating capacities add effortless warmth and comfort to your home whenever and wherever you want.

Kural PRODUCT	DIMENSIONS		HEAT OUTPUT	Finishes								
				White	RAL	Matt	Gloss	Dupont	Any	Other	Wood	Crocodile
				RAL 9010 W	9016 / 9001 / 1013 OW	Anodised MA	Anodised GA	Micrograin DX	RAL Colour RAL	Anodised AO	Effect WE	Textured CR
Height mm	Length mm	ΔT 50 BTU										
KUR409	450	445	1906	£440.16	£462.17	£462.17	£506.19	£501.78	£550.20	£594.22	£594.22	£616.23
KUR412	450	595	2541	£576.41	£605.23	£605.23	£662.87	£657.11	£720.51	£778.15	£778.15	£806.97
KUR415	450	745	3177	£712.64	£748.28	£748.28	£819.54	£812.41	£890.81	£962.07	£962.07	£997.70
KUR418	450	895	3812	£852.39	£895.00	£895.00	£980.24	£971.72	£1,065.48	£1,150.72	£1,150.72	£1,193.34
KUR421	450	1045	4447	£992.11	£1,041.72	£1,041.72	£1,140.93	£1,131.01	£1,240.14	£1,339.35	£1,339.35	£1,388.96
KUR425	450	1245	5294	£1,173.78	£1,232.46	£1,232.46	£1,349.84	£1,338.10	£1,467.22	£1,584.60	£1,584.60	£1,643.29
KUR429	450	1445	6141	£1,358.92	£1,426.86	£1,426.86	£1,562.76	£1,549.17	£1,698.65	£1,834.54	£1,834.54	£1,902.49
KUR435	450	1745	7412	£1,634.89	£1,716.64	£1,716.64	£1,880.13	£1,863.78	£2,043.62	£2,207.10	£2,207.10	£2,288.85
KUR440	450	1995	8471	£1,865.45	£1,958.72	£1,958.72	£2,145.27	£2,126.61	£2,331.81	£2,518.36	£2,518.36	£2,611.63
KUR609	600	445	2428	£503.04	£528.19	£528.19	£578.50	£573.47	£628.80	£679.10	£679.10	£704.26
KUR612	600	595	3238	£660.24	£693.26	£693.26	£759.28	£752.68	£825.30	£891.33	£891.33	£924.34
KUR615	600	745	4047	£820.94	£861.99	£861.99	£944.08	£935.87	£1,026.17	£1,108.27	£1,108.27	£1,149.31
KUR618	600	895	4857	£953.69	£1,001.38	£1,001.38	£1,096.75	£1,087.21	£1,192.12	£1,287.49	£1,287.49	£1,335.17
KUR621	600	1045	5666	£1,124.87	£1,181.11	£1,181.11	£1,293.60	£1,282.35	£1,406.08	£1,518.57	£1,518.57	£1,574.81
KUR625	600	1245	6746	£1,334.46	£1,401.18	£1,401.18	£1,534.62	£1,521.28	£1,668.07	£1,801.52	£1,801.52	£1,868.24
KUR629	600	1445	7825	£1,544.06	£1,621.26	£1,621.26	£1,775.67	£1,760.23	£1,930.08	£2,084.48	£2,084.48	£2,161.68
KUR635	600	1745	9444	£1,858.47	£1,951.39	£1,951.39	£2,137.24	£2,118.65	£2,323.08	£2,508.93	£2,508.93	£2,601.85
KUR640	600	1995	10793	£2,120.47	£2,226.49	£2,226.49	£2,438.54	£2,417.34	£2,650.59	£2,862.64	£2,862.64	£2,968.66
KUR1510	1500	495	5977	£1,068.97	£1,122.42	£1,122.42	£1,229.32	£1,218.63	£1,336.22	£1,443.11	£1,443.11	£1,496.56
KUR1512	1500	595	7173	£1,278.56	£1,342.49	£1,342.49	£1,470.35	£1,457.56	£1,598.20	£1,726.06	£1,726.06	£1,789.99
KUR1808	1800	395	5438	£1,041.02	£1,093.07	£1,093.07	£1,197.17	£1,186.76	£1,301.27	£1,405.38	£1,405.38	£1,457.43
KUR1810	1800	495	6797	£1,292.55	£1,357.17	£1,357.17	£1,486.43	£1,473.50	£1,615.68	£1,744.94	£1,744.94	£1,809.57
KUR1812	1800	595	8156	£1,544.06	£1,621.26	£1,621.26	£1,775.67	£1,760.23	£1,930.08	£2,084.48	£2,084.48	£2,161.68
KUR2008	2000	395	5984	£1,121.37	£1,177.44	£1,177.44	£1,289.58	£1,278.37	£1,401.72	£1,513.86	£1,513.86	£1,569.92
KUR2010	2000	495	7480	£1,390.36	£1,459.88	£1,459.88	£1,598.92	£1,585.02	£1,737.96	£1,876.99	£1,876.99	£1,946.51
KUR2012	2000	595	8976	£1,662.85	£1,745.99	£1,745.99	£1,912.27	£1,895.65	£2,078.56	£2,244.84	£2,244.84	£2,327.99

AL Material
 10 Working Pressure
 95°C Working Temp.
 C Closed System
 V Mounting Pos.
 10 YEARS Warranty
 £ Prices Ex. VAT

Luvre

Concave curves

Solid and stylish, this curved panel radiator packs a powerful punch, both aesthetically and when it comes to heat performance.

White RAL 9010
Image for illustration purposes

UDW850
Thermostatic Valve
£63.65+VAT

CYH850TW
Thermostatic Valve
£70.66+VAT





Scan for full technical specification

Valves and Accessories from page 90

This model has been designed for maximum durability to withstand life in a busy household or office.

Available in a wide range of colours and finishes, including wood effect, to match existing interior design or to inspire a whole new look.

Luvre	DIMENSIONS		HEAT OUTPUT	Finishes								
	Height mm	Length mm		White RAL 9010 W	RAL 9016 / 9001 / 1013 OW	Matt Anodised MA	Gloss Anodised GA	Dupont Micrograin DX	Any RAL Colour RAL	Other Anodised AO	Wood Effect WE	Crocodile Textured CR
BLU607	600	485	2104	£482.21	£506.32	£506.32	£554.54	£549.72	£602.76	£650.99	£650.99	£675.10
BLU609	600	625	2705	£606.38	£636.70	£636.70	£697.34	£691.28	£757.98	£818.62	£818.62	£848.94
BLU611	600	765	3306	£742.47	£779.59	£779.59	£853.84	£846.41	£928.08	£1,002.33	£1,002.33	£1,039.45
BLU613	600	905	3907	£877.89	£921.78	£921.78	£1,009.57	£1,000.79	£1,097.36	£1,185.15	£1,185.15	£1,229.04
BLU614	600	975	4207	£943.29	£990.45	£990.45	£1,084.78	£1,075.35	£1,179.11	£1,273.44	£1,273.44	£1,320.61
BLU615	600	1045	4508	£1,010.65	£1,061.18	£1,061.18	£1,162.25	£1,152.14	£1,263.31	£1,364.38	£1,364.38	£1,414.91
BLU618	600	1255	5409	£1,211.12	£1,271.68	£1,271.68	£1,392.79	£1,380.68	£1,513.90	£1,635.01	£1,635.01	£1,695.57
BLU621	600	1465	6311	£1,416.24	£1,487.05	£1,487.05	£1,628.67	£1,614.51	£1,770.30	£1,911.92	£1,911.92	£1,982.73
BLU625	600	1745	7513	£1,681.79	£1,765.87	£1,765.87	£1,934.05	£1,917.24	£2,102.23	£2,270.41	£2,270.41	£2,354.50
BLU628	600	1955	8415	£1,885.92	£1,980.21	£1,980.21	£2,168.81	£2,149.95	£2,357.40	£2,545.99	£2,545.99	£2,640.28
BLU1505	1500	345	3087	£689.64	£724.12	£724.12	£793.08	£786.19	£862.05	£931.01	£931.01	£965.49
BLU1507	1500	485	4320	£961.13	£1,009.19	£1,009.19	£1,105.30	£1,095.69	£1,201.41	£1,297.52	£1,297.52	£1,345.58
BLU1509	1500	625	5553	£1,237.90	£1,299.79	£1,299.79	£1,423.58	£1,411.21	£1,547.37	£1,671.16	£1,671.16	£1,733.06
BLU1510	1500	695	6171	£1,373.31	£1,441.97	£1,441.97	£1,579.30	£1,565.57	£1,716.63	£1,853.96	£1,853.96	£1,922.63
BLU1803	1800	205	2418	£502.68	£527.82	£527.82	£578.09	£573.06	£628.36	£678.62	£678.62	£703.76
BLU1804	1800	275	3224	£657.92	£690.81	£690.81	£756.60	£750.02	£822.40	£888.19	£888.19	£921.08
BLU1805	1800	345	4030	£825.05	£866.30	£866.30	£948.80	£940.55	£1,031.31	£1,113.81	£1,113.81	£1,155.06
BLU1806	1800	415	4836	£986.88	£1,036.23	£1,036.23	£1,134.91	£1,125.04	£1,233.60	£1,332.29	£1,332.29	£1,381.63
BLU1807	1800	485	5642	£1,154.00	£1,211.70	£1,211.70	£1,327.10	£1,315.56	£1,442.50	£1,557.90	£1,557.90	£1,615.60
BLU1809	1800	625	7253	£1,482.96	£1,557.11	£1,557.11	£1,705.41	£1,690.58	£1,853.70	£2,002.00	£2,002.00	£2,076.15
BLU2005	2000	345	4559	£908.93	£954.38	£954.38	£1,045.27	£1,036.19	£1,136.17	£1,227.06	£1,227.06	£1,272.51
BLU2007	2000	485	6383	£1,268.93	£1,332.38	£1,332.38	£1,459.27	£1,446.58	£1,586.16	£1,713.06	£1,713.06	£1,776.50
BLU2009	2000	625	8206	£1,628.94	£1,710.39	£1,710.39	£1,873.28	£1,857.00	£2,036.18	£2,199.07	£2,199.07	£2,280.52

AL 10 95°C C V 10 YEARS £
 Material Working Pressure Working Temp. Closed System Mounting Pos. Warranty Prices Ex. VAT

BLU621W
 White RAL 9010
£1,416.24
 +VAT



MIR1802W
White RAL 9010
£524.44 +VAT

MTBRALW
White RAL 9010
Towel Bar
£84.72
+VAT

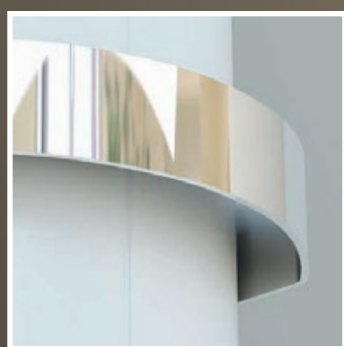

MTBP
Polished Stainless Steel
Towel Bar
£173.61 +VAT

CYL850MC
Manual Valve
£40.49 +VAT

TWU850TC
Thermostatic Valve
£107.46 +VAT



Mira

Smart and slender arc

A flexible design that you can customise with several accessories, including towel bars and hooks. One towel bar is included and additional bars are available to order separately.



Scan for full technical specification

Valves and Accessories from page 90

Mira				Finishes								
PRODUCT	DIMENSIONS		HEAT OUTPUT ΔT 50 BTU	White	RAL	Matt	Gloss	Dupont	Any	Other	Wood	Crocodile
	Height mm	Length mm		White RAL 9010 W	9016 / 9001 / 1013 OW	Anodised MA	Anodised GA	Micrograin DX	Any RAL Colour RAL	Anodised AO	Wood Effect WE	Crocodile Textured CR
MIR1202	1200	210	1639	£463.85	£487.04	£487.04	£533.43	£528.79	£579.81	£626.20	£626.20	£649.39
MIR1502	1500	210	2049	£491.01	£515.56	£515.56	£564.66	£559.75	£613.76	£662.87	£662.87	£687.42
MIR1802	1800	210	2459	£524.44	£550.66	£550.66	£603.10	£597.86	£655.55	£707.99	£707.99	£734.21
MTBRAL	Towel Bar Attachment (Mild Steel)			£84.72	£88.96	£88.96	£97.43	£96.58	£105.90	£114.37	£114.37	£118.61
MTBP	Towel Bar Attachment (Polished Stainless Steel)			£173.61								

AL Working Pressure Working Temp. 95°C C Closed System V Mounting Pos. 10 YEARS Warranty £ Prices Ex. VAT



Plateau

Sophisticated style

Climb to the very top of sophisticated style with this modern towel rail that looks great and feels even better. One towel bar is included and additional bars are available to order separately.

PLT1806MA
Matt Anodised
£736.12^{+VAT}

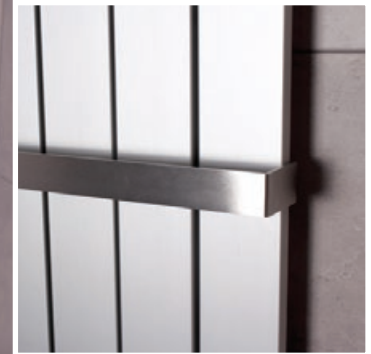

PLTTB5P
Polished Towel Bar
£126.72
^{+VAT}

UAW853TS
Thermostatic Valve
£92.88^{+VAT}

TWU850TC
Thermostatic Valve
£107.46^{+VAT}



Scan for full technical specification

Valves and Accessories from page 90

Plateau				Finishes										
PRODUCT	DIMENSIONS		HEAT OUTPUT											
	Height mm	Length mm		ΔT 50 BTU	White RAL 9010 W	9016 / 9001 / 1013 OW	Anodised MA	Anodised GA	Dupont Micrograin DX	Any RAL Colour RAL	Other Anodised AO	Wood Effect WE	Crocodile Textured CR	Brushed Matt S
PLT1203	1200	265	1106	£313.42	£329.09	£329.09	£360.43	£357.30	£391.78	£423.12	£423.12	£438.79		
PLT1503	1500	265	1383	£329.09	£345.55	£345.55	£378.46	£375.16	£411.36	£444.27	£444.27	£460.73		
PLT1803	1800	265	1537	£371.25	£389.81	£389.81	£426.93	£423.22	£464.06	£501.18	£501.18	£519.75		
PLT1804	1800	355	2049	£481.20	£505.26	£505.26	£553.38	£548.57	£601.50	£649.62	£649.62	£673.68		
PLT1805	1800	445	2558	£592.94	£622.58	£622.58	£681.88	£675.95	£741.17	£800.46	£800.46	£830.11		
PLT1806	1800	535	3070	£701.07	£736.12	£736.12	£806.23	£799.22	£876.34	£946.45	£946.45	£981.50		
PLT2003	2000	265	1708	£407.53	£427.91	£427.91	£468.66	£464.59	£509.41	£550.17	£550.17	£570.54		
PLT2004	2000	355	2277	£523.96	£550.16	£550.16	£602.55	£597.31	£654.95	£707.34	£707.34	£733.54		

Plateau Towel Bar

PLTTB3	40	277		£70.40	£73.92	£73.92	£80.96	£80.26	£88.00	£95.04	£95.04	£98.56	£77.44	£91.52
PLTTB4	40	370		£84.48	£88.70	£88.70	£97.15	£96.31	£105.60	£114.05	£114.05	£118.27	£98.56	£112.64
PLTTB5	40	457		£98.56	£103.49	£103.49	£113.34	£112.36	£123.20	£133.06	£133.06	£137.98	£112.64	£126.72
PLTTB6	40	547		£112.64	£118.27	£118.27	£129.54	£128.41	£140.80	£152.06	£152.06	£157.70	£140.80	£168.96

Material
 Working Pressure
 Working Temp.
 Closed System
 Mounting Pos.
 Warranty
 Prices Ex. VAT

Porte

Contemporary chic

Open the door to contemporary beauty and charm with this chic, unobtrusive radiator that will suit any space.



POR607WE
 Natural Oak Wood Effect
£1,151.61^{+VAT}



UDC860
 Thermostatic Valve
£110.20^{+VAT}

UAW853TS
 Thermostatic Valve
£92.88^{+VAT}



Scan for full technical specification

Valves and Accessories from page 90

Available in striking finishes, including crocodile texture and wood effect to fulfil any interior designer's dream.

Slimline and lightweight, this radiator is easy to install and maintain for years to come.

PRODUCT	DIMENSIONS		HEAT OUTPUT ΔT 50 BTU	Finishes								
				White RAL 9010 W	RAL 9016 / 9001 / 1013 OW	Matt Anodised MA	Gloss Anodised GA	Dupont Micrograin DX	Any RAL Colour RAL	Other Anodised AO	Wood Effect WE	Crocodile Textured CR
	Height mm	Length mm		White RAL 9010 W	RAL 9016 / 9001 / 1013 OW	Matt Anodised MA	Gloss Anodised GA	Dupont Micrograin DX	Any RAL Colour RAL	Other Anodised AO	Wood Effect WE	Crocodile Textured CR
POR602	600	278	1018	£251.52	£264.10	£264.10	£289.25	£286.73	£314.40	£339.55	£339.55	£352.13
POR603	600	418	1527	£373.29	£391.95	£391.95	£429.28	£425.55	£466.61	£503.94	£503.94	£522.61
POR604	600	558	2035	£495.72	£520.51	£520.51	£570.08	£565.13	£619.66	£669.23	£669.23	£694.01
POR605	600	698	2544	£618.16	£649.07	£649.07	£710.88	£704.70	£772.70	£834.51	£834.51	£865.42
POR606	600	838	3053	£740.59	£777.62	£777.62	£851.68	£844.28	£925.74	£999.80	£999.80	£1,036.83
POR607	600	978	3562	£853.05	£895.70	£895.70	£981.00	£972.47	£1,066.31	£1,151.61	£1,151.61	£1,194.26
POR609	600	1258	4580	£1,095.25	£1,150.01	£1,150.01	£1,259.54	£1,248.59	£1,369.06	£1,478.59	£1,478.59	£1,533.35
POR610	600	1398	4986	£1,203.05	£1,263.20	£1,263.20	£1,383.50	£1,371.47	£1,503.81	£1,624.11	£1,624.11	£1,684.27
POR612	600	1678	6106	£1,442.59	£1,514.72	£1,514.72	£1,658.98	£1,644.55	£1,803.24	£1,947.50	£1,947.50	£2,019.63
POR613	600	1818	6615	£1,561.70	£1,639.78	£1,639.78	£1,795.95	£1,780.34	£1,952.12	£2,108.29	£2,108.29	£2,186.38
POR614	600	1958	7124	£1,515.12	£1,590.88	£1,590.88	£1,742.39	£1,727.24	£1,893.90	£2,045.41	£2,045.41	£2,121.17
POR1502	1500	278	2042	£459.79	£482.78	£482.78	£528.76	£524.16	£574.74	£620.72	£620.72	£643.71
POR1503	1500	418	3060	£711.31	£746.88	£746.88	£818.01	£810.90	£889.14	£960.27	£960.27	£995.84
POR1505	1500	698	5102	£1,167.78	£1,226.17	£1,226.17	£1,342.95	£1,331.27	£1,459.73	£1,576.50	£1,576.50	£1,634.89
POR1803	1800	418	3289	£840.40	£882.42	£882.42	£966.46	£958.06	£1,050.50	£1,134.54	£1,134.54	£1,176.56
POR1804	1800	558	4385	£1,121.87	£1,177.96	£1,177.96	£1,290.15	£1,278.93	£1,402.33	£1,514.52	£1,514.52	£1,570.61
POR1805	1800	698	5481	£1,398.01	£1,467.91	£1,467.91	£1,607.71	£1,593.73	£1,747.51	£1,887.31	£1,887.31	£1,957.21
POR2003	2000	418	3504	£926.90	£973.25	£973.25	£1,065.94	£1,056.67	£1,158.63	£1,251.32	£1,251.32	£1,297.67
POR2004	2000	558	4672	£1,201.05	£1,261.10	£1,261.10	£1,381.21	£1,369.20	£1,501.31	£1,621.42	£1,621.42	£1,681.47
POR2005	2000	698	5840	£1,499.82	£1,574.81	£1,574.81	£1,724.79	£1,709.79	£1,874.77	£2,024.75	£2,024.75	£2,099.74

AL Material
 10 Working Pressure
 95°C Working Temp.
 C Closed System
 V Mounting Pos.
 10 YEARS Warranty
 £ Prices Ex. VAT



White RAL 9010

SMY616W
White RAL 9010

£843.29^{+VAT}



TWU850TW
Thermostatic Valve
£127.33^{+VAT}

Smyrna

Fair and square

Fall in love with this fun, chunky design that lies flat against the wall and exudes playfulness and practicality.

White RAL 9010
Image for illustration purposes only



Scan for full technical specification
Valves and Accessories from page 90



Smyrna				Finishes								
PRODUCT	DIMENSIONS		HEAT OUTPUT ΔT 50 BTU									
	Height mm	Length mm		White RAL 9010 W	RAL 9016 / 9001 / 1013 OW	Matt Anodised MA	Gloss Anodised GA	Dupont Micrograin DX	Any RAL Colour RAL	Other Anodised AO	Wood Effect WE	Crocodile Textured CR
SMY608	600	555	1953	£421.30	£442.37	£442.37	£484.50	£480.28	£526.63	£568.76	£568.76	£589.82
SMY610	600	695	2442	£523.31	£549.48	£549.48	£601.81	£596.57	£654.14	£706.47	£706.47	£732.64
SMY612	600	835	2930	£632.30	£663.92	£663.92	£727.15	£720.83	£790.38	£853.61	£853.61	£885.23
SMY613	600	905	3176	£683.30	£717.47	£717.47	£785.80	£778.96	£854.13	£922.46	£922.46	£956.62
SMY614	600	975	3418	£733.61	£770.29	£770.29	£843.65	£836.32	£917.01	£990.37	£990.37	£1,027.05
SMY616	600	1115	3907	£843.29	£885.46	£885.46	£969.79	£961.35	£1,054.12	£1,138.45	£1,138.45	£1,180.61
SMY619	600	1325	4641	£995.61	£1,045.39	£1,045.39	£1,144.95	£1,135.00	£1,244.51	£1,344.07	£1,344.07	£1,393.86
SMY622	600	1535	5372	£1,155.60	£1,213.38	£1,213.38	£1,328.94	£1,317.39	£1,444.50	£1,560.06	£1,560.06	£1,617.84
SMY625	600	1745	6106	£1,307.92	£1,373.32	£1,373.32	£1,504.11	£1,491.03	£1,634.90	£1,765.69	£1,765.69	£1,831.09
SMY628	600	1955	6837	£1,467.91	£1,541.31	£1,541.31	£1,688.10	£1,673.42	£1,834.89	£1,981.68	£1,981.68	£2,055.07
SMY1505	1500	345	2619	£530.98	£557.53	£557.53	£610.63	£605.32	£663.73	£716.83	£716.83	£743.38
SMY1507	1500	485	3668	£721.02	£757.07	£757.07	£829.18	£821.97	£901.28	£973.38	£973.38	£1,009.43
SMY1509	1500	625	4716	£923.65	£969.83	£969.83	£1,062.20	£1,052.96	£1,154.56	£1,246.92	£1,246.92	£1,293.11
SMY1510	1500	695	5242	£1,024.95	£1,076.20	£1,076.20	£1,178.70	£1,168.45	£1,281.19	£1,383.69	£1,383.69	£1,434.94
SMY1805	1800	345	3026	£658.85	£691.79	£691.79	£757.67	£751.08	£823.56	£889.44	£889.44	£922.38
SMY1807	1800	485	4235	£899.90	£944.89	£944.89	£1,034.88	£1,025.88	£1,124.87	£1,214.86	£1,214.86	£1,259.85
SMY1808	1800	555	4839	£1,019.36	£1,070.33	£1,070.33	£1,172.27	£1,162.07	£1,274.20	£1,376.14	£1,376.14	£1,427.11
SMY1809	1800	625	5444	£1,143.03	£1,200.18	£1,200.18	£1,314.48	£1,303.05	£1,428.79	£1,543.09	£1,543.09	£1,600.24
SMY2005	2000	345	3313	£705.66	£740.94	£740.94	£811.51	£804.45	£882.08	£952.64	£952.64	£987.93
SMY2007	2000	485	4638	£964.17	£1,012.38	£1,012.38	£1,108.80	£1,099.15	£1,205.21	£1,301.63	£1,301.63	£1,349.84
SMY2008	2000	555	5300	£1,099.01	£1,153.97	£1,153.97	£1,263.87	£1,252.88	£1,373.77	£1,483.67	£1,483.67	£1,538.62
SMY2009	2000	625	5963	£1,239.45	£1,301.42	£1,301.42	£1,425.37	£1,412.97	£1,549.31	£1,673.26	£1,673.26	£1,735.23

Material
 Working Pressure
 Working Temp.
 Closed System
 Mounting Pos.
 Warranty
 Prices Ex. VAT

VRT621W
White RAL 9010

£1,470.71^{+VAT}



UDW850
Thermostatic Valve
£63.65^{+VAT}

CYH850TW
Thermostatic Valve
£70.66^{+VAT}

Virtu

A visual delight

Don't wait too long for this beautiful design. Convex and concave panels complement intricate patterns running along the top.

Smooth, curvaceous design that produces excellent heat that more than matches its beguiling beauty.

Easily customisable with several different colour options, finishes, textures and sizes available.



Scan for full technical specification

Valves and Accessories from page 90

Virtu	DIMENSIONS		HEAT OUTPUT	Finishes								
	Height mm	Length mm		White RAL 9010 W	RAL 9016 / 9001 / 1013 OW	Matt Anodised MA	Gloss Anodised GA	Dupont Micrograin DX	Any RAL Colour RAL	Other Anodised AO	Wood Effect WE	Crocodile Textured CR
VRT607	600	485	2104	£500.77	£525.81	£525.81	£575.88	£570.88	£625.96	£676.04	£676.04	£701.08
VRT609	600	625	2705	£629.71	£661.20	£661.20	£724.17	£717.87	£787.14	£850.11	£850.11	£881.60
VRT611	600	765	3306	£771.02	£809.57	£809.57	£886.67	£878.96	£963.78	£1,040.88	£1,040.88	£1,079.43
VRT613	600	905	3907	£912.07	£957.68	£957.68	£1,048.89	£1,039.76	£1,140.09	£1,231.30	£1,231.30	£1,276.90
VRT614	600	975	4207	£979.57	£1,028.55	£1,028.55	£1,126.51	£1,116.71	£1,224.47	£1,322.42	£1,322.42	£1,371.40
VRT615	600	1045	4508	£1,049.52	£1,102.00	£1,102.00	£1,206.95	£1,196.46	£1,311.90	£1,416.86	£1,416.86	£1,469.33
VRT618	600	1255	5409	£1,258.75	£1,321.69	£1,321.69	£1,447.56	£1,434.98	£1,573.44	£1,699.32	£1,699.32	£1,762.25
VRT621	600	1465	6311	£1,470.71	£1,544.25	£1,544.25	£1,691.32	£1,676.61	£1,838.39	£1,985.46	£1,985.46	£2,059.00
VRT625	600	1745	7513	£1,746.48	£1,833.81	£1,833.81	£2,008.46	£1,990.99	£2,183.10	£2,357.75	£2,357.75	£2,445.08
VRT628	600	1955	8415	£1,958.46	£2,056.38	£2,056.38	£2,252.23	£2,232.64	£2,448.07	£2,643.92	£2,643.92	£2,741.84
VRT1505	1500	345	3087	£716.15	£751.96	£751.96	£823.57	£816.41	£895.19	£966.80	£966.80	£1,002.61
VRT1507	1500	485	4320	£998.09	£1,047.99	£1,047.99	£1,147.80	£1,137.82	£1,247.61	£1,347.42	£1,347.42	£1,397.32
VRT1509	1500	625	5553	£1,285.50	£1,349.78	£1,349.78	£1,478.33	£1,465.47	£1,606.88	£1,735.43	£1,735.43	£1,799.71
VRT1510	1500	695	6171	£1,426.12	£1,497.43	£1,497.43	£1,640.04	£1,625.78	£1,782.65	£1,925.26	£1,925.26	£1,996.57
VRT1803	1800	205	2418	£522.02	£548.12	£548.12	£600.32	£595.10	£652.52	£704.72	£704.72	£730.82
VRT1804	1800	275	3224	£683.23	£717.39	£717.39	£785.72	£778.88	£854.04	£922.36	£922.36	£956.52
VRT1805	1800	345	4030	£856.77	£899.61	£899.61	£985.28	£976.72	£1,070.96	£1,156.64	£1,156.64	£1,199.48
VRT1806	1800	415	4836	£1,024.81	£1,076.05	£1,076.05	£1,178.53	£1,168.29	£1,281.02	£1,383.50	£1,383.50	£1,434.74
VRT1807	1800	485	5642	£1,198.38	£1,258.30	£1,258.30	£1,378.13	£1,366.15	£1,497.97	£1,617.81	£1,617.81	£1,677.73
VRT1809	1800	625	7253	£1,540.00	£1,617.00	£1,617.00	£1,771.00	£1,755.60	£1,925.00	£2,079.00	£2,079.00	£2,156.00
VRT2005	2000	345	4559	£943.90	£991.09	£991.09	£1,085.48	£1,076.04	£1,179.87	£1,274.26	£1,274.26	£1,321.45
VRT2007	2000	485	6383	£1,317.75	£1,383.63	£1,383.63	£1,515.41	£1,502.23	£1,647.18	£1,778.96	£1,778.96	£1,844.85
VRT2009	2000	625	8206	£1,691.60	£1,776.18	£1,776.18	£1,945.34	£1,928.42	£2,114.50	£2,283.66	£2,283.66	£2,368.24

AL 10 95°C C V 10 YEARS £
 Material Working Pressure Working Temp. Closed System Mounting Pos. Warranty Prices Ex. VAT



Matt Anodised
Image for illustration
purposes only

UDC850
Thermostatic Valve
£63.65^{+VAT}

CYL850MC
Manual Valve
£40.49^{+VAT}

CYH850TC
Thermostatic Valve
£57.80^{+VAT}

Visage

Designer elegance

Turn your face towards this elegant, curved model that is worthy of any show home. Designer style at affordable prices.



Scan for full technical specification

Valves and Accessories from page 90

Metallic Micrograin Matt Black in Crocodile Texture



PRODUCT	DIMENSIONS		HEAT OUTPUT ΔT 50 BTU	Finishes									
	Height mm	Length mm		White RAL 9010 W	RAL 9016 / 9001 / 1013 OW	Matt Anodised MA	Gloss Anodised GA	Dupont Micrograin DX	Any RAL Colour RAL	Other Anodised AO	Wood Effect WE	Crocodile Textured CR	
VSG411	450	545	2141	£506.85	£532.19	£532.19	£582.88	£577.81	£633.56	£684.25	£684.25	£709.59	
VSG414	450	695	2725	£645.57	£677.85	£677.85	£742.40	£735.95	£806.96	£871.52	£871.52	£903.80	
VSG416	450	795	3114	£736.27	£773.09	£773.09	£846.71	£839.35	£920.34	£993.97	£993.97	£1,030.78	
VSG418	450	895	3504	£832.98	£874.63	£874.63	£957.93	£949.60	£1,041.22	£1,124.52	£1,124.52	£1,166.17	
VSG420	450	995	3893	£923.68	£969.87	£969.87	£1,062.23	£1,053.00	£1,154.60	£1,246.97	£1,246.97	£1,293.16	
VSG424	450	1195	4672	£1,104.42	£1,159.64	£1,159.64	£1,270.08	£1,259.03	£1,380.52	£1,490.96	£1,490.96	£1,546.18	
VSG428	450	1395	5450	£1,291.81	£1,356.40	£1,356.40	£1,485.58	£1,472.66	£1,614.76	£1,743.94	£1,743.94	£1,808.54	
VSG432	450	1595	6229	£1,472.54	£1,546.17	£1,546.17	£1,693.43	£1,678.70	£1,840.68	£1,987.94	£1,987.94	£2,061.56	
VSG436	450	1795	7008	£1,640.60	£1,722.63	£1,722.63	£1,886.69	£1,870.29	£2,050.75	£2,214.81	£2,214.81	£2,296.84	
VSG440	450	1995	7786	£1,819.35	£1,910.31	£1,910.31	£2,092.25	£2,074.05	£2,274.18	£2,456.12	£2,456.12	£2,547.08	
VSG607	600	345	1796	£419.48	£440.46	£440.46	£482.40	£478.21	£524.35	£566.30	£566.30	£587.28	
VSG609	600	445	2309	£533.54	£560.21	£560.21	£613.57	£608.23	£666.92	£720.27	£720.27	£746.95	
VSG611	600	545	2821	£652.24	£684.86	£684.86	£750.08	£743.56	£815.31	£880.53	£880.53	£913.14	
VSG614	600	695	3589	£830.31	£871.83	£871.83	£954.86	£946.56	£1,037.89	£1,120.92	£1,120.92	£1,162.44	
VSG616	600	795	4101	£949.02	£996.47	£996.47	£1,091.38	£1,081.89	£1,186.28	£1,281.18	£1,281.18	£1,328.63	
VSG618	600	895	4617	£1,067.06	£1,120.41	£1,120.41	£1,227.12	£1,216.44	£1,333.82	£1,440.53	£1,440.53	£1,493.88	
VSG620	600	995	5129	£1,186.44	£1,245.76	£1,245.76	£1,364.40	£1,352.54	£1,483.05	£1,601.69	£1,601.69	£1,661.01	
VSG624	600	1195	6154	£1,423.86	£1,495.05	£1,495.05	£1,637.43	£1,623.19	£1,779.82	£1,922.20	£1,922.20	£1,993.40	
VSG628	600	1395	7178	£1,660.61	£1,743.64	£1,743.64	£1,909.71	£1,893.10	£2,075.77	£2,241.83	£2,241.83	£2,324.86	
VSG632	600	1595	8206	£1,898.05	£1,992.95	£1,992.95	£2,182.75	£2,163.77	£2,372.56	£2,562.36	£2,562.36	£2,657.26	
VSG636	600	1795	9231	£2,134.79	£2,241.53	£2,241.53	£2,455.01	£2,433.66	£2,668.48	£2,881.96	£2,881.96	£2,988.70	
VSG640	600	1995	10255	£2,372.22	£2,490.83	£2,490.83	£2,728.05	£2,704.33	£2,965.27	£3,202.50	£3,202.50	£3,321.11	
VSG1506	1500	295	3173	£690.92	£725.47	£725.47	£794.56	£787.65	£863.65	£932.74	£932.74	£967.29	
VSG1508	1500	395	4228	£917.68	£963.56	£963.56	£1,055.33	£1,046.16	£1,147.10	£1,238.87	£1,238.87	£1,284.75	
VSG1510	1500	495	5286	£1,143.75	£1,200.94	£1,200.94	£1,315.31	£1,303.88	£1,429.69	£1,544.06	£1,544.06	£1,601.25	
VSG1512	1500	595	6345	£1,370.51	£1,439.04	£1,439.04	£1,576.09	£1,562.38	£1,713.14	£1,850.19	£1,850.19	£1,918.72	
VSG1805	1800	245	3060	£690.92	£725.47	£725.47	£794.56	£787.65	£863.65	£932.74	£932.74	£967.29	
VSG1807	1800	345	4286	£965.02	£1,013.27	£1,013.27	£1,109.78	£1,100.13	£1,206.28	£1,302.78	£1,302.78	£1,351.03	
VSG1809	1800	445	5508	£1,239.12	£1,301.08	£1,301.08	£1,424.99	£1,412.60	£1,548.91	£1,672.82	£1,672.82	£1,734.77	
VSG1810	1800	495	6120	£1,375.84	£1,444.63	£1,444.63	£1,582.21	£1,568.46	£1,719.80	£1,857.38	£1,857.38	£1,926.17	
VSG1812	1800	595	7346	£1,649.94	£1,732.44	£1,732.44	£1,897.43	£1,880.93	£2,062.43	£2,227.42	£2,227.42	£2,309.92	
VSG1814	1800	695	8568	£1,918.72	£2,014.65	£2,014.65	£2,206.52	£2,187.34	£2,398.39	£2,590.27	£2,590.27	£2,686.20	
VSG2003	2000	145	2015	£471.51	£495.09	£495.09	£542.24	£537.52	£589.39	£636.54	£636.54	£660.11	
VSG2007	2000	345	4702	£1,059.72	£1,112.71	£1,112.71	£1,218.68	£1,208.08	£1,324.65	£1,430.63	£1,430.63	£1,483.61	
VSG2009	2000	445	6048	£1,360.51	£1,428.54	£1,428.54	£1,564.59	£1,550.98	£1,700.64	£1,836.69	£1,836.69	£1,904.72	
VSG2010	2000	495	6120	£1,513.23	£1,588.89	£1,588.89	£1,740.21	£1,725.08	£1,891.53	£2,042.86	£2,042.86	£2,118.52	
VSG2012	2000	595	8063	£1,813.34	£1,904.01	£1,904.01	£2,085.34	£2,067.21	£2,266.68	£2,448.01	£2,448.01	£2,538.68	
VSG2014	2000	695	9405	£2,114.12	£2,219.82	£2,219.82	£2,431.23	£2,410.09	£2,642.65	£2,854.06	£2,854.06	£2,959.76	

AL 10 95°C C V 10 YEARS £
 Material Working Pressure Working Temp. Closed System Mounting Pos. Warranty Prices Ex. VAT

RAL COLOURS & METALLIC FINISHES



C6050716R
6 Column Radiator
Anthracite RAL 7016

ULTRAHEAT RAL COLOURS

Discover the vibrant world of RAL colours, designed to complement your existing interior décor and add some visual appeal to your newly installed heated towel rails and radiators. A huge range of custom colours is available to individualise your favourite designs.

Choose from soothing pastels, popping primary colours and sleek, shiny metallic finishes. Colour options available wherever you see the 'Available in RAL Colours' icon inside this catalogue.

Custom RAL colours come in a gloss finish as standard, unless stated differently. The finish options are gloss, semi-gloss and matt.

Bespoke metallic finishes are available in gloss and semi-gloss. Please contact us for further information.



Scan for more on RAL Colours

					
RAL 9010 Pure White	RAL 9016 Traffic White	RAL 9001 Cream	RAL 1013 Oyster White	RAL 9022 Pearl Light Grey	RAL 7003 Moss Grey
					
RAL 5005 Signal Blue	RAL 5002 Ultramarine	RAL 7016 Anthracite	RAL 5013 Cobalt Blue	RAL 9004 Signal Black	RAL 9005 Jet Black
					
RAL 6019 Pastel Green	RAL 6011 Reseda Green	RAL 1016 Sulfur Yellow	RAL 2004 Pure Orange	RAL 3000 Flame Red	RAL 4006 Traffic Purple

The RAL colours shown in the chart and photography, while a good representation, may not be an exact match of the finished product. Please allow 10-14 days delivery lead time for a bespoke painted radiator. In special cases some products may have a longer lead time. Please contact us for further information.



KD628R Klön Horizontal in RAL 5005 Signal Blue



C2061125R 2 Column Radiator in RAL 1016 Sulfur Yellow



EXCLUSIVE ALUMINIUM FINISHES



KAV420-6MA
Kavis
Matt Anodised

ULTRAHEAT ALUMINIUM FINISHES

Our range of aluminium finishes adds style, heating performance and personality to your newly designed home. Choose anodisation for a hard-wearing layer that is as durable as it is beautiful. It helps prevent corrosion and keeps your radiators and towel rails looking new for longer.

AVAILABLE IN RAL Add any RAL colour to your aluminium finish to add aesthetic appeal. Different textures offer different effects, including our popular textured crocodile skin, sandy Dupont

micrograin finish and the fully reflective, sleek and oxidised gloss anodised finish.

All aluminium RAL colours come in high-gloss as standard. If you prefer matt, this can also be provided as a special order.

Bring the outdoors in with our unusual, beautiful wood effect finish. We apply computer aided paint onto your chosen aluminium radiator. Choose between Teak, Mahogany, Walnut and Oak.



Matt Anodised
MA



Gloss Anodised
GA

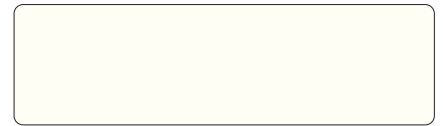

Pure White RAL 9010
Hi-Gloss / Gloss / Matt



Traffic White RAL 9016
Hi-Gloss / Gloss / Matt



Wood Effect
WE
Teak / Mahogany / Walnut / Oak



Crocodile Texture
CR
Available in any RAL colour



Dupont Micrograin
DX
Matt Sandy Texture



Other Anodised
AO

Scan for more on
aluminium finishes



POR607WE Porte in Natural Oak Wood Effect finish



HES106MA Hestia in Matt Anodised finish

VALVES COMPATIBILITY

Ultraheat valves come in a range of styles, designs and finishes, giving you an excellent choice to accessorise your radiators. Valves may perform very different functions, but that doesn't mean they can't be stylish as well.



Scan for more on valves and accessories

VALVES	ARGUS	BANIO	BOMBE/LUVRE	BUCKINGHAM	CHELMSFORD STRAIGHT	CHELMSFORD ARCHED	2 COLUMN	3 COLUMN	4 COLUMN	6 COLUMN	DEVON	DIANA	ECO-RAIL	HAMPTON COMPACT 4	HAMPTON PLANAL	HERAN	HESTIA	HYPO	IMPERIUM	KARNAK	KAVIS	KLON HORIZONTAL	KLON VERTICAL	KUPKA	KURAL
UD850	✓	✓	✓	✓	✓	✓	✓	✓	✓	✓	✓	✓	✓	✓	✓	✓	✓	✓	✓	✓	✓	✓	✓	✓	✓
UD851	✓	✓	✓	✓	✓	✓	✓	✓	✓	✓	✓	✓	✓	✓	✓	✓	✓	✓	✓	✓	✓	✓	✓	✓	✓
UD860	✓	✓	✓	✓	✓	✓	✓	✓	✓	✓	✓	✓	✓	✓	✓	✓	✓	✓	✓	✓	✓	✓	✓	✓	✓
UD927	✓	✓	✓	✓	✓	✓	✓	✓	✓	✓	✓	✓	✓	✓	✓	✓	✓	✓	✓	✓	✓	✓	✓	✓	✓
CUH841	✓	✓	✓	✓	✓	✓	✓	✓	✓	✓	✓	✓	✓	✓	✓	✓	✓	✓	✓	✓	✓	✓	✓	✓	✓
CUH840	✓	✓	✓	✓	✓	✓	✓	✓	✓	✓	✓	✓	✓	✓	✓	✓	✓	✓	✓	✓	✓	✓	✓	✓	✓
MIN840	✓	✓	✓	✓	✓	✓	✓	✓	✓	✓	✓	✓	✓	✓	✓	✓	✓	✓	✓	✓	✓	✓	✓	✓	✓
ONE851	✓	✓	✓	✓	✓	✓	✓	✓	✓	✓	✓	✓	✓	✓	✓	✓	✓	✓	✓	✓	✓	✓	✓	✓	✓
TWI850	✓	✓	✓	✓	✓	✓	✓	✓	✓	✓	✓	✓	✓	✓	✓	✓	✓	✓	✓	✓	✓	✓	✓	✓	✓
TWI851	✓	✓	✓	✓	✓	✓	✓	✓	✓	✓	✓	✓	✓	✓	✓	✓	✓	✓	✓	✓	✓	✓	✓	✓	✓
COR850	✓	✓	✓	✓	✓	✓	✓	✓	✓	✓	✓	✓	✓	✓	✓	✓	✓	✓	✓	✓	✓	✓	✓	✓	✓
CYL840	✓	✓	✓	✓	✓	✓	✓	✓	✓	✓	✓	✓	✓	✓	✓	✓	✓	✓	✓	✓	✓	✓	✓	✓	✓
P925	✓	✓	✓	✓	✓	✓	✓	✓	✓	✓	✓	✓	✓	✓	✓	✓	✓	✓	✓	✓	✓	✓	✓	✓	✓
P926	✓	✓	✓	✓	✓	✓	✓	✓	✓	✓	✓	✓	✓	✓	✓	✓	✓	✓	✓	✓	✓	✓	✓	✓	✓
P915	✓	✓	✓	✓	✓	✓	✓	✓	✓	✓	✓	✓	✓	✓	✓	✓	✓	✓	✓	✓	✓	✓	✓	✓	✓
P916	✓	✓	✓	✓	✓	✓	✓	✓	✓	✓	✓	✓	✓	✓	✓	✓	✓	✓	✓	✓	✓	✓	✓	✓	✓
D13G	✓	✓	✓	✓	✓	✓	✓	✓	✓	✓	✓	✓	✓	✓	✓	✓	✓	✓	✓	✓	✓	✓	✓	✓	✓
DRASC	✓	✓	✓	✓	✓	✓	✓	✓	✓	✓	✓	✓	✓	✓	✓	✓	✓	✓	✓	✓	✓	✓	✓	✓	✓
VHS-str	✓	✓	✓	✓	✓	✓	✓	✓	✓	✓	✓	✓	✓	✓	✓	✓	✓	✓	✓	✓	✓	✓	✓	✓	✓
CHRV	✓	✓	✓	✓	✓	✓	✓	✓	✓	✓	✓	✓	✓	✓	✓	✓	✓	✓	✓	✓	✓	✓	✓	✓	✓
CYH850M	✓	✓	✓	✓	✓	✓	✓	✓	✓	✓	✓	✓	✓	✓	✓	✓	✓	✓	✓	✓	✓	✓	✓	✓	✓
CYH850T	✓	✓	✓	✓	✓	✓	✓	✓	✓	✓	✓	✓	✓	✓	✓	✓	✓	✓	✓	✓	✓	✓	✓	✓	✓
CYH851M	✓	✓	✓	✓	✓	✓	✓	✓	✓	✓	✓	✓	✓	✓	✓	✓	✓	✓	✓	✓	✓	✓	✓	✓	✓
CYH851T	✓	✓	✓	✓	✓	✓	✓	✓	✓	✓	✓	✓	✓	✓	✓	✓	✓	✓	✓	✓	✓	✓	✓	✓	✓
CYH853M	✓	✓	✓	✓	✓	✓	✓	✓	✓	✓	✓	✓	✓	✓	✓	✓	✓	✓	✓	✓	✓	✓	✓	✓	✓
CYH853T	✓	✓	✓	✓	✓	✓	✓	✓	✓	✓	✓	✓	✓	✓	✓	✓	✓	✓	✓	✓	✓	✓	✓	✓	✓
CYL850M	✓	✓	✓	✓	✓	✓	✓	✓	✓	✓	✓	✓	✓	✓	✓	✓	✓	✓	✓	✓	✓	✓	✓	✓	✓
CYL851M	✓	✓	✓	✓	✓	✓	✓	✓	✓	✓	✓	✓	✓	✓	✓	✓	✓	✓	✓	✓	✓	✓	✓	✓	✓
CUH850M	✓	✓	✓	✓	✓	✓	✓	✓	✓	✓	✓	✓	✓	✓	✓	✓	✓	✓	✓	✓	✓	✓	✓	✓	✓
CUH851M	✓	✓	✓	✓	✓	✓	✓	✓	✓	✓	✓	✓	✓	✓	✓	✓	✓	✓	✓	✓	✓	✓	✓	✓	✓
CUH853M	✓	✓	✓	✓	✓	✓	✓	✓	✓	✓	✓	✓	✓	✓	✓	✓	✓	✓	✓	✓	✓	✓	✓	✓	✓
CUL850M	✓	✓	✓	✓	✓	✓	✓	✓	✓	✓	✓	✓	✓	✓	✓	✓	✓	✓	✓	✓	✓	✓	✓	✓	✓
CUL851M	✓	✓	✓	✓	✓	✓	✓	✓	✓	✓	✓	✓	✓	✓	✓	✓	✓	✓	✓	✓	✓	✓	✓	✓	✓
QUA850M	✓	✓	✓	✓	✓	✓	✓	✓	✓	✓	✓	✓	✓	✓	✓	✓	✓	✓	✓	✓	✓	✓	✓	✓	✓
QUA851M	✓	✓	✓	✓	✓	✓	✓	✓	✓	✓	✓	✓	✓	✓	✓	✓	✓	✓	✓	✓	✓	✓	✓	✓	✓
TLB850M	✓	✓	✓	✓	✓	✓	✓	✓	✓	✓	✓	✓	✓	✓	✓	✓	✓	✓	✓	✓	✓	✓	✓	✓	✓
BCH850M	✓	✓	✓	✓	✓	✓	✓	✓	✓	✓	✓	✓	✓	✓	✓	✓	✓	✓	✓	✓	✓	✓	✓	✓	✓
BCH851M	✓	✓	✓	✓	✓	✓	✓	✓	✓	✓	✓	✓	✓	✓	✓	✓	✓	✓	✓	✓	✓	✓	✓	✓	✓
TWU850T	✓	✓	✓	✓	✓	✓	✓	✓	✓	✓	✓	✓	✓	✓	✓	✓	✓	✓	✓	✓	✓	✓	✓	✓	✓
UAW850NT	✓	✓	✓	✓	✓	✓	✓	✓	✓	✓	✓	✓	✓	✓	✓	✓	✓	✓	✓	✓	✓	✓	✓	✓	✓
UAW851NT	✓	✓	✓	✓	✓	✓	✓	✓	✓	✓	✓	✓	✓	✓	✓	✓	✓	✓	✓	✓	✓	✓	✓	✓	✓
UAW850NLT	✓	✓	✓	✓	✓	✓	✓	✓	✓	✓	✓	✓	✓	✓	✓	✓	✓	✓	✓	✓	✓	✓	✓	✓	✓
UAW851NLT	✓	✓	✓	✓	✓	✓	✓	✓	✓	✓	✓	✓	✓	✓	✓	✓	✓	✓	✓	✓	✓	✓	✓	✓	✓
UAW850T	✓	✓	✓	✓	✓	✓	✓	✓	✓	✓	✓	✓	✓	✓	✓	✓	✓	✓	✓	✓	✓	✓	✓	✓	✓
UAWH850T	✓	✓	✓	✓	✓	✓	✓	✓	✓	✓	✓	✓	✓	✓	✓	✓	✓	✓	✓	✓	✓	✓	✓	✓	✓
UAW851T	✓	✓	✓	✓	✓	✓	✓	✓	✓	✓	✓	✓	✓	✓	✓	✓	✓	✓	✓	✓	✓	✓	✓	✓	✓
UAWH851T	✓	✓	✓	✓	✓	✓	✓	✓	✓	✓	✓	✓	✓	✓	✓	✓	✓	✓	✓	✓	✓	✓	✓	✓	✓
UAW853T	✓	✓	✓	✓	✓	✓	✓	✓	✓	✓	✓	✓	✓	✓	✓	✓	✓	✓	✓	✓	✓	✓	✓	✓	✓
RTAVW	✓	✓	✓	✓	✓	✓	✓	✓	✓	✓	✓	✓	✓	✓	✓	✓	✓	✓	✓	✓	✓	✓	✓	✓	✓

Manual Valves



ANGLE
BCH850M
Barrel Cross Angle Manual Radiator Valve + L/S Set

Chrome	C	£63.66
Brushed Matt	S	£73.88



ANGLE
CUH840MC
Cube - Manual Angle Valve Pair Complete with 15mm Tube Connectors

Chrome	C	£192.40
--------	---	---------



ANGLE
CUH840MS
Cube - Manual Angle Valve Pair Complete with 15mm Tube Connectors

Brushed Matt	S	£265.85
--------------	---	---------



ANGLE
CUL850MC
Cubic-25 Angle Manual Radiator Valve + L/S Set

Chrome	C	£61.77
--------	---	--------



ANGLE
CYL850MC
Cylindrical-30 Angle Manual Rad. Valve + L/S Set

Chrome	C	£40.49
--------	---	--------



ANGLE
CYL850MS
Cylindrical-30 Angle Manual Rad. Valve + L/S Set

Brushed Matt	S	£40.49
--------------	---	--------



ANGLE
CYL850MB
Cylindrical-30 Angle Manual Rad. Valve + L/S Set

Black RAL 9005	B	£40.11
----------------	---	--------



ANGLE
CYL850MA
Cylindrical-30 Angle Manual Rad. Valve + L/S Set

Anthracite RAL 7016	A	£40.11
---------------------	---	--------



ANGLE
QUA850MC
Quartz-30 Angle Manual Rad. Valve + L/S Set

Chrome	C	£66.97
--------	---	--------



ANGLE
QUA850MS
Quartz-30 Angle Manual Rad. Valve + L/S Set

Brushed Matt	S	£74.18
--------------	---	--------



ANGLE
TLB850MC
Traditional Cross Head Angle Manual Rad. Valve + L/S Set

Chrome	C	£79.93
--------	---	--------



ANGLE
TLB850MS
Traditional Cross Head Angle Manual Rad. Valve + L/S Set

Brushed Matt	S	£92.23
--------------	---	--------



ANGLE
CUH850M
Cubic-30 Angle Manual Rad. Valve + L/S Set

Chrome	C	£102.35
Brushed Matt	S	£110.58



STRAIGHT
BCH851MC
Blade Cross Straight Manual Rad. Valve + L/S Set

Chrome	C	£69.91
--------	---	--------



STRAIGHT
CUH841C
Cube - Manual Straight Valve Pair Complete with 15mm Tube Connectors

Chrome	C	£192.40
--------	---	---------



STRAIGHT
CUH841S
Cube - Manual Straight Valve Pair Complete with 15mm Tube Connectors

Brushed Matt	S	£265.85
--------------	---	---------

All prices ex. VAT

Manual Valves



STRAIGHT
CUH851M
Cubic-30 Straight Manual Rad. Valve + L/S Set

Brushed Matt	S	£121.37
Chrome	C	£112.28



STRAIGHT
CUL851MC
Cubic-25 Straight Manual Rad. Valve + L/S Set

Chrome	C	£65.55
--------	---	--------



STRAIGHT
QUA851MC
Quartz-30 Straight Manual Rad. Valve + L/S Set

Chrome	C	£72.85
--------	---	--------



STRAIGHT
CYH851MC
Cylindrical-30 Straight Manual Rad. Valve + L/S Set

Chrome	C	£49.88
--------	---	--------



STRAIGHT
CYH851MS
Cylindrical-30 Straight Manual Rad. Valve + L/S Set

Brushed Matt	S	£54.96
--------------	---	--------



STRAIGHT
CYL851M
Cylindrical-25 Straight Manual Rad. Valve + L/S Set

Chrome	C	£41.28
Brushed Matt	S	£40.94



STRAIGHT
CYL851MB
Cylindrical-25 Straight Manual Rad. Valve + L/S Set

Black RAL 9005	B	£40.51
----------------	---	--------



STRAIGHT
CYL851MA
Cylindrical-25 Straight Manual Rad. Valve + L/S Set

Anthracite RAL 7016	A	£40.51
---------------------	---	--------



ANGLE
CHRVG
Cross Head Manual Radiator Valve Set with Sleeves

Gold Polished	G	£189.11
		While stocks last



ANGLE
CHRVC
Cross Head Manual Radiator Valve Set with Sleeves

Chrome	C	£136.19
		While stocks last



ANGLE
CYH850MC
Cylindrical-30 Angle Manual Rad. Valve + L/S Set

Chrome	C	£47.30
--------	---	--------



ANGLE
CYH850MS
Cylindrical-30 Angle Manual Rad. Valve + L/S Set

Brushed Matt	S	£50.74
--------------	---	--------



CORNER
CUH853MC
Cubic-30 Corner Manual Rad. Valve + L/S Set

Chrome	C	£90.43
--------	---	--------



CORNER
CUH853MS
Cubic-30 Corner Manual Rad. Valve + L/S Set

Brushed Matt	S	£104.43
--------------	---	---------



CORNER
CYH853M
Cylindrical-30 Corner Manual Rad. Valve + L/S Set

Chrome	C	£56.76
White RAL 9016	W	£68.01



CORNER
CYH853MA
Cylindrical-30 Corner Manual Rad. Valve + L/S Set

Brushed Matt	S	£66.60
Black RAL 9005	B	£68.01
Anthracite RAL 7016	A	£68.01

All prices ex. VAT

Thermostatic Valves



TWIN Angle/Straight
TWU850T

Twin Valve TRV Angle/Straight
(6 ports) with TRV Liquid Sensor
Head, Couplings and Reducers

Chrome	C	£107.46
White RAL 9016	W	£127.33



TWIN Angle/Straight
TWU850TS

Twin Valve TRV Angle/Straight
(6 ports) with TRV Liquid Sensor
Head, Couplings and Reducers

Brushed Matt	S	£127.23
--------------	---	---------



TWIN Angle/Straight
TWU850TB

Twin Valve TRV Angle/Straight
(6 ports) with TRV Liquid Sensor
Head, Couplings and Reducers

Black RAL 9005	B	£127.23
----------------	---	---------



TWIN Angle/Straight
TWU850TA

Twin Valve TRV Angle/Straight
(6 ports) with TRV Liquid Sensor
Head, Couplings and Reducers

Anthraccite RAL 7016	A	£127.23
----------------------	---	---------



TWIN Angle/Straight
TWU850TG

Twin Valve TRV Angle/Straight
(6 ports) with TRV Liquid Sensor
Head, Couplings and Reducers

Matt Gold	G	£147.19
-----------	---	---------



ANGLE
UAW850TC

Eco Angle Thermostatic Valve

Chrome	C	£19.39
--------	---	--------



ANGLE
UAW850NTW

Eco Angle Thermostatic Valve &
TRV Head

White RAL 9016	W	£29.93
----------------	---	--------



ANGLE
UAW850NLTW

Eco Angle Thermostatic Valve &
TRV Head/LS Twin Pack

White RAL 9016	W	£43.77
----------------	---	--------



ANGLE
CYH850TC

Cylindrical-30 Angle GB TRV
30mm Body + Cylindrical L/S with
TRV Liquid Sensor Head

Chrome	C	£57.80
--------	---	--------



ANGLE
CYH850TS

Cylindrical-30 Angle GB TRV
30mm Body + Cylindrical L/S with
TRV Liquid Sensor Head

Brushed Matt	S	£70.00
--------------	---	--------



ANGLE
CYH850TW

Cylindrical-30 Angle GB TRV
30mm Body + Cylindrical L/S with
TRV Liquid Sensor Head

White RAL 9016	W	£70.66
----------------	---	--------



ANGLE
CYH850TB

Cylindrical-30 Angle GB TRV
30mm Body + Cylindrical L/S with
TRV Liquid Sensor Head

Black RAL 9005	B	£70.66
----------------	---	--------



ANGLE
CYH850TA

Cylindrical-30 Angle GB TRV
30mm Body + Cylindrical L/S with
TRV Liquid Sensor Head

Anthraccite RAL 7016	A	£70.66
----------------------	---	--------



ANGLE
CYH850TG

Cylindrical-30 Angle GB TRV
30mm Body + Cylindrical L/S with
TRV Liquid Sensor Head

Matt Gold	G	£75.58
-----------	---	--------



STRAIGHT
UAW851NLTW

Eco Straight Thermostatic Valve &
TRV Head/LS Twin Pack

White RAL 9016	W	£46.16
----------------	---	--------



STRAIGHT
UAW851TC

Eco Straight Thermostatic Valve

Chrome	C	£19.39
--------	---	--------

All prices ex. VAT

Thermostatic Valves



STRAIGHT
UAW851NTW
Eco Straight Thermostatic Valve & TRV Head
White RAL 9016 W £31.78



STRAIGHT
CYH851T
Cylindrical-30 Straight GB TRV
30mm Body + Cylindrical L/S with TRV Liquid Sensor Head
Chrome C £60.64
Brushed Matt S £74.85



STRAIGHT
CYH851TW
Cylindrical-30 Straight GB TRV
30mm Body + Cylindrical L/S with TRV Liquid Sensor Head
White RAL 9016 W £74.45



STRAIGHT
CYH851TB
Cylindrical-30 Straight GB TRV
30mm Body + Cylindrical L/S with TRV Liquid Sensor Head
Black RAL 9005 B £74.45



STRAIGHT
CYH851TA
Cylindrical-30 Straight GB TRV
30mm Body + Cylindrical L/S with TRV Liquid Sensor Head
Anthracite RAL 7016 A £74.45



STRAIGHT
CYH851TG
Cylindrical-30 Straight GB TRV
30mm Body + Cylindrical L/S with TRV Liquid Sensor Head
Matt Gold G £80.41



CORNER
CYH853TW
Cylindrical-30 Corner TRV & 30mm Lockshield with TRV Liquid Sensor Head and O-Ring Tail (Set)
White RAL 9016 W £90.30



CORNER
CYH853T
Cylindrical-30 Corner TRV & 30mm Lockshield with TRV Liquid Sensor Head and O-Ring Tail (Set)
Anthracite RAL 7016 A £90.30
Black RAL 9005 B £90.30



CORNER
UAW853TC
Eco Corner Thermostatic Valve & TRV Head
Chrome C £79.12



CORNER
UAW853TS
Eco Corner Thermostatic Valve & TRV Head
Brushed Matt S £92.88



ANGLE
UDW850
DÉCOR Angle Valve Pair Complete with 15mm Tube Connectors
White RAL 9016 W £63.65
While stocks last



ANGLE
UDC850
DÉCOR Angle Valve Pair Complete with 15mm Tube Connectors
Chrome C £63.65
While stocks last



ANGLE
MIN840C
Minimalist - Manual Angle Valve Pair Complete with 15mm Tube Connectors
Chrome C £172.60
While stocks last



ANGLE
CYL840C
Cylinder - Manual Angle Valve Pair Complete with 15mm Tube Connectors
Chrome C £86.30
While stocks last



ANGLE
CYL840S
Cylinder - Manual Angle Valve Pair Complete with 15mm Tube Connectors
Brushed Matt S £111.95
While stocks last



TWIN Angle
TWI850S
Twin - Thermostatic Angle Valve Complete with 15mm Tube Connectors
Brushed Matt S £158.60
While stocks last

All prices ex. VAT

VALVES & ACCESSORIES

Thermostatic Valves



TWIN Straight
TWI851

Twin - Thermostatic Straight Valve Complete with 15mm Tube Connectors

Chrome	C	£125.95
Brushed Matt	S	£158.60
		While stocks last



STRAIGHT
UD851

DÉCOR Straight Valve Pair Complete with 15mm Tube Connectors

Brushed Matt	S	£73.45
Chrome	C	£63.65
		While stocks last



STRAIGHT
VHS-str

Danfoss Undermount Thermostatic Valve - Straight White

White RAL 9016	W	£161.60
		While stocks last



SWIVEL
UDC860

DÉCOR Swivel Valve Pair Complete with 15mm Tube Connectors

Chrome	C	£110.20
		While stocks last



SWIVEL
UDC927

INTERAXIAL Swivel 50 Valve Pair Complete with 15 Tube Connectors & Domignon Sensor

Chrome	C	£157.95
		While stocks last



SWIVEL
UDS927

INTERAXIAL Swivel 50 Valve Pair Complete with 15 Tube Connectors & Domignon Sensor

Brushed Matt	S	£181.20
		While stocks last



SWIVEL
UDW927

INTERAXIAL Swivel 50 Valve Pair Complete with 15 Tube Connectors & Domignon Sensor

White RAL 9016	W	£157.95
		While stocks last



CORNER
COR850C

Corner - Thermostatic Angle Valve Pair Complete with 15mm Tube Connectors

Chrome	C	£106.10
		While stocks last



A409

Liquid Metal Sensor

Chrome	C	£54.80
Brushed Matt	S	£87.45
		While stocks last



A574

Manual Knob for Thermostatic Radiator Valves (TRV)

Brushed Matt	S	£14.35
		While stocks last



UA109C

TRV Head

Chrome	C	£21.76
--------	---	--------



UA109S

TRV Head

Brushed Matt	S	£28.38
--------------	---	--------



UA109W

TRV Head

White RAL 9016	W	£28.09
----------------	---	--------



UA109B

TRV Head

Matt Black RAL 9005	B	£27.62
---------------------	---	--------



UA109

TRV Head

Anthracite RAL 7016	A	£27.43
Matt Gold	G	£28.09



UD109L

Domignon Liquid Plastic Sensor

Chrome	C	£42.85
White RAL 9016	W	£42.85
Brushed Matt	S	£45.30
		While stocks last

Thermostatic Valves



STRAIGHT
UAWH851T
Eco Straight TRV + White/Chrome Sensor TRV Head
Chrome C **£39.26**



ANGLE
UAWH850T
Eco Angle TRV + White/Chrome TRV Head
Chrome C **£39.26**



H7760
Herz Sensor Standard
White RAL 9016 W **£19.60**
While stocks last



DRASC
Danfoss Sensor
White RAL 9016 W **£28.15**
While stocks last



D13G
Danfoss Thermostatic Insert with Pre-Setting
Nickel N **£18.52**



RTAVW
For use with LSOrad.
Close Coupled TRV with W/H & L/S Valves and 2m Capillary Tube
White RAL 9016 W **£204.21**

H Valves



STRAIGHT
P925
Straight "H" Valve Without By-Pass - Nickel Plated
Nickel N **£35.26**
While stocks last



ANGLE
P926
Angle "H" Valve Without By-Pass - Nickel Plated
Nickel N **£40.55**
While stocks last



STRAIGHT
P915
Straight "H" Valve With By-Pass - Nickel Plated
Nickel N **£44.06**
While stocks last



ANGLE
P916
Angle "H" Valve With By-Pass - Nickel Plated
Nickel N **£47.63**
While stocks last

Our assortment of valves and accessories expand beyond this catalogue.



Scan for more on valves and accessories

All prices ex. VAT

T: +44 (0)1908 010333 F: +44 (0)1908 640017 E: heating-sales@pitacs.com W: www.ultraheat.co.uk

PREMIER RANGE



VALVES & ACCESSORIES

Adapting Sets, Tube Connectors and Reducing Kits



P3015SC14

3/4"x18x10x14 Complete Adapting Set For Multi-Layer Pipe

Chrome C £7.85



P3015SS14

3/4"x18x10x14 Complete Adapting Set For Multi-Layer Pipe

Brushed Matt S £8.86



P3015SC16

3/4"x18x10x16 Complete Adapting Set For Multi-Layer Pipe

Chrome C £7.85



P3015SS16

3/4"x18x10x16 Complete Adapting Set For Multi-Layer Pipe

Brushed Matt S £8.86



P3625S

3/4"BSP x 15mm Copper Tube Connector In Brushed Matt Plated

Brushed Matt S £14.42



P3625N

3/4"BSP x 15mm Copper Tube Connector In Nickel Plated

Nickel N £11.15



P3625C

3/4"BSP x 15mm Copper Tube Connector In Chrome Plated

Chrome C £11.15



P3015S

3/4"BSP x 18 x 13 x 16mm Plastic Tube Connector In Brushed Matt

Brushed Matt S £13.23



10RP5

10mm Reducing Kit (pack of 5)

Matt Brass £8.51



P99SP

Drain Device - Brass

Brushed Matt S £33.48



A335C

Copper Pipe Adaptor 15mm 3/4" EK

Chrome S £7.60
While stocks last



16PEX

16mm PEX couplings - Pack of 2

White RAL 9016	Chrome	Brushed Matt	Matt Anthracite RAL 7016	Matt Black RAL 9005	Matt Gold	Matt Bronze
W	C	S	A	B	G	Q
£7.56	£7.56	£8.51	£7.56	£7.56	£9.08	£9.08

There are three options for twin valves:

1. UDS927, UDC927, UDW927 (see page 94)
2. A set of: DRASC/H7760, H-Valves, P99SP, D13G, P3625C/S/N, P3015S
3. TWU valves (see page 92)

All prices ex. VAT

Heating Elements

Class I or Class II Standard Heating Elements 70°C Thermostat, 128°C Thermal fuse



HE600

600W Heating Element With 70°C Thermostat, 127°C Thermal Fuse, Cable Length: 1.5m, 760mm Rod Length

Nickel N £81.44

HE900

900W Heating Element With 70°C Thermostat, 127°C Thermal Fuse, Cable Length: 1.5m, 1050mm Rod Length

Nickel N £97.48

HE90

90W Heating Element With 70°C Thermostat, 127°C Thermal Fuse, Cable Length: 1.5m, 205mm Rod Length

Nickel N £80.01

HE300

300W Heating Element With 70°C Thermostat, 127°C Thermal Fuse, Cable Length: 1.5m, 450mm Rod Length

Nickel N £72.77

HE150

150W Heating Element With 70°C Thermostat, 127°C Thermal Fuse, Cable Length: 1.5m, 300mm Rod Length

Nickel N £69.85

HE400

400W Heating Element With 70°C Thermostat, 127°C Thermal Fuse, Cable Length: 1.5m, 550mm Rod Length

Nickel N £75.68

HES340

340W Heating Element, PTC Self Regulation, Cable Length: 1.5m, 240mm Rod Length

Nickel N £80.01

HES400

400W Heating Element, PTC Self Regulation, Cable Length: 1.5m, 240mm Rod Length

Nickel N £84.35

Heat Transfer Liquid

7HTL

Heat Transfer Liquid for up to 750mm high rails

£73.66

9HTL

Heat Transfer Liquid for up to 900mm high rails

£85.54

11HTL

Heat Transfer Liquid for up to 1200mm high rails

£99.79

17HTL

Heat Transfer Liquid for up to 1800mm high rails

£139.00

20HTL

Heat Transfer Liquid for up to 2000mm high rails

£190.08

Thermostatic Valves



STRAIGHT ONE851C

One - Thermostatic Straight Valve Complete with 15mm Tube Connectors

Chrome C £114.30
While stocks last



STRAIGHT ONE851S

One - Thermostatic Straight Valve Complete with 15mm Tube Connectors

Brushed Matt S £148.10
While stocks last



H9260

Herz Sensor - Porsche

White RAL 9016 W £24.50
While stocks last

Enables Standard Element to be controlled



3BV

1/2" BSP 3Bar Valve for Electric Only Towel Rails

Chrome C £11.82
Nickel N £11.82

Dual Fuel Components



TPW

1/2" BSP T Piece for Dual Fuel Operation

White RAL 9016 W £13.07



TPC

1/2" BSP T Piece for Dual Fuel Operation

Chrome C £13.07



TPS

1/2" BSP T Piece for Dual Fuel Operation

Brushed Matt S £16.04



4w-TRV+

4 Way Radiator Valve with Thermostatic Control (White Sensor and Nickel Plated Body)

Nickel N £135.43

All prices ex. VAT

Analogue Heating Elements

The Control Box and Rod Joint as a set of two parts, Class I only



POS400W

400W Poseidon Heating Element With 70°C Thermostat, 127°C Thermal Fuse
Cable Length: 150cm, Rod Length: 550mm

White RAL 9016

W **£120.66**
While stocks last



POS400C

400W Poseidon Heating Element With 70°C Thermostat, 127°C Thermal Fuse
Cable Length: 150cm, Rod Length: 550mm

Chrome

C **£137.64**
While stocks last



POS400S

400W Poseidon Heating Element With 70°C Thermostat, 127°C Thermal Fuse
Cable Length: 150cm, Rod Length: 550mm

Brushed Matt

S **£137.64**
While stocks last

POS600W

600W Poseidon Heating Element With 70°C Thermostat, 127°C Thermal Fuse
Cable Length: 150cm, Rod Length: 760mm

White RAL 9016

W **£128.21**
While stocks last

POS600C

600W Poseidon Heating Element With 70°C Thermostat, 127°C Thermal Fuse
Cable Length: 150cm, Rod Length: 760mm

Chrome

C **£145.18**
While stocks last

POS600S

600W Poseidon Heating Element With 70°C Thermostat, 127°C Thermal Fuse
Cable Length: 150cm, Rod Length: 760mm

Brushed Matt

S **£145.18**
While stocks last



Aquarius: Analogue Heating Elements

The Control Box and Rod Joint as one piece, Class I only

AQ300

300W Aquarius Heating Element With 70°C Thermostat, 127°C Thermal Fuse
Cable Length: 150cm, Rod Length: 450mm

White RAL 9016	Chrome	Brushed Matt / Grey
W	C	S
£71.65	£90.51	£90.51

While stocks last

While stocks last

While stocks last

AQ600

600W Aquarius Heating Element with 70°C Thermostat, 127°C Thermal Fuse
Cable Length: 150cm, Rod Length: 760mm

White RAL 9016	Chrome	Brushed Matt / Grey
W	C	S
£75.41	£94.29	£94.29

While stocks last

While stocks last

While stocks last



Analogue Heating Elements

The Control Box and Rod Joint as one piece, Stainless Steel Class I only

AES400

400W Dimhead Heating Element
Straight Type

Chrome	Brushed Matt / Grey
C	S
£103.72	£103.72

While stocks last

While stocks last

AES600

600W Dimhead Heating Element
Straight Type

Chrome	Brushed Matt / Grey
C	S
£113.15	£113.15

While stocks last

While stocks last

All prices ex. VAT



Mobus: Analogue Heating Elements

The Control Box and Rod Joint as one piece, Class I only

MB150

150W Mobus PTC Heating Element, Cable Length: 90cm, Class I Insulation

White RAL 9016	Chrome
W	C
£105.05	£122.54

While stocks last

While stocks last

MB300

300W Mobus PTC Heating Element, Cable Length: 90cm, Class I Insulation

White RAL 9016	Chrome
W	C
£107.75	£126.61

While stocks last

While stocks last

MB600

600W Mobus PTC Heating Element, Cable Length: 90cm, Class I Insulation

White RAL 9016	Chrome
W	C
£118.53	£136.02

While stocks last

While stocks last



Stoke: Analogue Heating Elements

The Control Box and Rod Joint as a set of two parts, Class I and Class II

STCN-1

Stoke Control Box, Bluetooth Low Energy, Class I Insulation (for UK +)

White RAL 9016	Chrome
W	C
£160.27	£173.75

While stocks last

While stocks last

STCN-2

Stoke Control Box, Bluetooth Low Energy, Class II Insulation (for France)

White RAL 9016	Chrome
W	C
£141.41	£152.19

While stocks last

While stocks last



ST150-1

150W Stoke Heating Element Rod For Stoke Control Unit, Class I Insulation (for UK+)

Nickel	N	£42.17
		While stocks last

ST400-1

400W Stoke Heating Element Rod For Stoke Control Unit, Class I Insulation (for UK+)

Nickel	N	£46.55
		While stocks last

ST600-1

600W Stoke Heating Element Rod For Stoke Control Unit, Class I Insulation (for UK+)

Nickel	N	£49.46
		While stocks last

ST900-1

900W Stoke Heating Element Rod For Stoke Control Unit, Class I Insulation (for UK+)

Nickel	N	£52.36
		While stocks last

ST150-2

150W Stoke Heating Element Rod For Stoke Control Unit, Class II Insulation (for France)

Nickel	N	£45.08
		While stocks last

ST400-2

400W Stoke Heating Element Rod For Stoke Control Unit, Class II Insulation (for France)

Nickel	N	£49.46
		While stocks last

ST600-2

600W Stoke Heating Element Rod For Stoke Control Unit, Class II Insulation (for France)

Nickel	N	£52.39
		While stocks last

ST900-2

900W Stoke Heating Element Rod For Stoke Control Unit, Class II Insulation (for France)

Nickel	N	£55.30
		While stocks last

Please order a control box (STCN) and a Heating Element (ST) together to make a complete set.

All prices ex. VAT

VALVES & ACCESSORIES

The **NEW** Oswest Wi-Fi Enabled Smart Heating Element

The new Oswest Wi-Fi Enabled Smart Heating Element connects the latest smart technology with elegant design and reliable home heating.

This must-have heating accessory turns a standard towel rail into an intelligent heat source, controlled by your smartphone 24/7.

A dedicated Oswest App allows you to control heat levels and timings, with anti-freeze and open window functions to reduce your household's energy consumption.



OWS300CL1

300w Oswest Smart Heating Element
Wi-Fi enabled

White RAL 9016	W	£122.00
Chrome	C	£128.00
Anthracite RAL 7016	A	£122.00

OWS600CL1

600w Oswest Smart Heating Element
Wi-Fi enabled

White RAL 9016	W	£127.00
Chrome	C	£133.00
Anthracite RAL 7016	A	£127.00

OWS900CL1

900w Oswest Smart Heating Element
Wi-Fi enabled

White RAL 9016	W	£131.00
Chrome	C	£137.00



All prices ex. VAT

Enables Standard Element to be controlled

**WPC600**

600W Wall Plate Controller for Standard Heating Cartridge

White RAL 9016	W	£78.53
Chrome	C	£87.26

**P1400**

25mm Pattress Box (Supplied Min 10pcs in a Carton)

White RAL 9016	W	£1.60
----------------	---	-------

P1300

16mm Pattress Box (Supplied Min 10pcs in a Carton)

White RAL 9016	W	£1.31
----------------	---	-------

Airvents and Accessories

**SJA**

1/2" Standard Airvent with "O" Ring - Nickel Plated

Nickel	N	£4.22
--------	---	-------

**SJP**

1/2" Standard Plug with "O" Ring - Nickel Plated

Nickel	N	£3.15
--------	---	-------

**SJA-w**

1/2" Standard Nickel Airvent with "O" Ring and White Plastic Water Diverter

Nickel	N	£4.69
--------	---	-------

**SJA157**

1/2" Type 157 Nickel Airvent Flat D26 Hex 8 1/2" EPDM

Nickel	N	£7.96
--------	---	-------

C1574W

Plastic Cup For Type 157 Airvent and 154 Plug

White RAL 9016	W	£2.32
----------------	---	-------

C1574C

Plastic Cup For Type 157 Airvent and 154 Plug

Chrome	C	£2.32
--------	---	-------

C1574S

Plastic Cup For Type 157 Airvent and 154 Plug

Brushed Matt	S	£2.32
--------------	---	-------

SJP154

1/2" Type 157 Nickel Plug Flat D26 Hex 8 1/2" EPDM

Nickel	N	£6.00
--------	---	-------

**SJAC-h**

1/2" Designer Chrome Airvent with "O" ring, Semi-Auto

Chrome	C	£38.79
--------	---	--------

**SJPC-h**

1/2" Designer Chrome Plug with "O" Ring

Chrome	C	£14.55
--------	---	--------

**ASJA**

1/2" Full Automatic Airvent with Changeable Cartridge

Nickel	N	£21.32
--------	---	--------

**SPF**

1/2" BSP Straight Male to 15mm Pipe Push Fit - Nickel Plated Only

Nickel	N	£19.22
--------	---	--------

All prices ex. VAT

T: +44 (0)1908 010333 F: +44 (0)1908 640017 E: heating-sales@pitacs.com W: www.ultraheat.co.uk

PREMIER RANGE

Clip-On Accessories Compatibility

Ultraheat clip-on accessories come in a range of styles, designs and finishes, giving you an excellent choice to accessorise your radiators.

Product	Length	Clip-on accessories											
		VH	TRTH	TR	TD	TPH	BH	6TAB	5TAB	6TB	5TB	4TB	2M5X65S+B
Chelmsford Arched	420mm	✓		✓		✓	✓						
	500mm	✓		✓		✓	✓		✓				
	600mm	✓		✓		✓	✓		✓				
	750mm	✓		✓		✓	✓	✓	✓				
Chelmsford Straight	310mm	✓		✓		✓	✓						
	420mm	✓		✓		✓	✓						
	500mm	✓		✓	✓	✓	✓					✓	
	600mm	✓		✓	✓	✓	✓				✓	✓	
	750mm	✓		✓	✓	✓	✓			✓	✓	✓	
Eco Rail	400mm	✓		✓		✓	✓						
	500mm	✓		✓	✓	✓	✓					✓	
	600mm	✓		✓	✓	✓	✓				✓	✓	
Poplar	500mm	✓		✓	✓	✓	✓					✓	
Windsor	500mm	✓		✓	✓	✓	✓					✓	

Column		✓		✓		✓	✓			✓(15)			
Imperium	260mm	✓		✓		✓	✓						✓
Klon		✓*		✓*	✓(11)*	✓*	✓*			✓(17)*			✓
Linear		✓		✓		✓	✓			✓(13)			
Sofi		✓		✓		✓	✓						
Tilbrook		✓		✓		✓	✓				✓(19)*	✓(16)*	✓
Trojan	390mm		✓										

Banio	425mm	✓		✓		✓	✓					✓	
	525mm	✓		✓	✓	✓	✓				✓	✓	
Diana	525mm	✓		✓	✓	✓	✓				✓	✓	
	625mm	✓		✓	✓	✓	✓				✓	✓	
Hestia	500mm	✓		✓	✓	✓	✓					✓	
	600mm	✓		✓	✓	✓	✓				✓	✓	
Kupka	425mm	✓		✓	✓	✓	✓					✓	
	525mm	✓	✓	✓	✓	✓	✓				✓	✓	

- ✓ The accessory is compatible with this radiator or bathroom rail
 - ✓* Accessory requires **2M5X65S+B** Pack to fit
 - ✓(N) Accessory requires minimum number of tubes/sections (N) to fit
 - ✓(N)* Accessory requires minimum number of tubes/sections (N) and **2M5X65S-B** Pack to fit
- 2M5X65S+B** is a fixing pack and is provided free of charge with specified radiators
- N: Number of tubes/sections

Clip-On Accessories



BHC
Button Robe Hanger (Pair)
Chrome C **£28.27**



BHW
Button Robe Hanger (Pair)
White RAL 9016 W **£18.87**



4TB
400mm Clip-on Towel Bar for
Straight Shape Multi-Rail Towel
Warmer
White RAL 9016 W **£38.12**
Chrome C **£46.59**



5TB
500mm Clip-on Towel Bar for
Straight Shape Multi-Rail Towel
Warmer
White RAL 9016 W **£35.97**
Chrome C **£44.44**



6TB
600mm Clip-on Towel Bar for
Straight Shape Multi-Rail Towel
Warmer
White RAL 9016 W **£38.12**
Chrome C **£46.59**



5TABW
500mm Towel Bar Arched
Multi-Rail Towel Warmer
White RAL 9016 W **£41.75**



5TABC
500mm Towel Bar Arched
Multi-Rail Towel Warmer
Chrome C **£49.50**



6TABW
600mm Clip-on Towel Bar for
Arched Multi-Rail Towel Warmer
White RAL 9016 W **£43.78**



6TABC
600mm Clip-on Towel Bar for
Arched Multirail Towel Warmer
Chrome C **£51.59**



VHW
V Hook (Pair)
White RAL 9016 W **£28.27**



VHC
V Hook (Pair)
Chrome C **£33.94**



TPH
Toilet Paper Holder
White RAL 9016 W **£49.56**
Chrome C **£59.40**



TR
Towel Ring
Chrome C **£57.26**
White RAL 9016 W **£51.15**



TD
Towel Dryer
Chrome C **£98.34**
White RAL 9016 W **£76.34**

All prices ex. VAT

Central Heating Treatments



766743
Ultraheat Central Heating System Inhibitor

500ml £6.30



766750
Ultraheat Central Heating System Cleaner

500ml £6.30



768822
Ultraheat Central Heating 22mm Full Compliance Kit

£81.97



768808
Ultraheat Central Heating 22mm Magnetic Filter

£52.27



768815
Ultraheat Central Heating 15mm Electrolytic Scale Reducer

£24.59

All prices ex. VAT

Floor Brackets

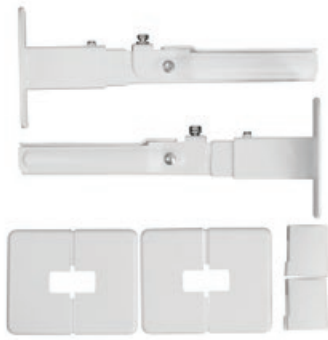

SFB
Floor Bracket for Single (Type SF, PSS)
Horizontal Panel Radiators
White RAL 9016 W **£61.72**

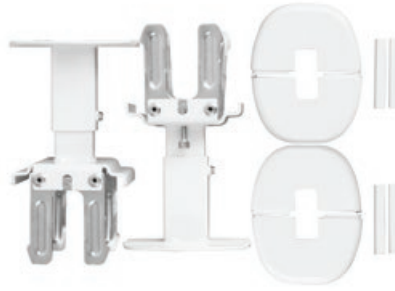

DFB
Floor Bracket for Double & Triple (Type DF, DS,
TF, TS) Horizontal Panel Radiators
White RAL 9016 W **£70.51**



UFB
Universal Floor Brackets for Horizontal Panel
Radiators
White RAL 9016 W **£61.72**

Concealed Wall Brackets (Compact 4 & Compact 6 only)



6CW
Concealed Wall Brackets For
600mm High Horizontal Panel
Radiators
Nickel N **£6.53**

7CW
Concealed Wall Brackets For
700mm High Horizontal Panel
Radiators
Nickel N **£7.40**

2CW
Concealed Wall Brackets For
200mm High Horizontal Panel
Radiators
Nickel N **£4.49**

3CW
Concealed Wall Brackets For
300mm High Horizontal Panel
Radiators
Nickel N **£4.67**

4CW
Concealed Wall Brackets For
400mm High Horizontal Panel
Radiators
Nickel N **£4.93**

5CW
Concealed Wall Brackets For
500mm High Horizontal Panel
Radiators
Nickel N **£5.64**

9CW
Concealed Wall Brackets for 900mm
High Horizontal & 1200, 1400,
1600mm for Vertical Panel Radiators
Nickel N **£8.81**

12CW
Concealed Wall Brackets For
1800 - 2000mm High Vertical
Panel Radiators
Nickel N **£9.25**

MB4-st
Set Of Wall Brackets For Straight
Type Towel Rail (Windsor)
White RAL 9016 W **£75.97**
Chrome C **£75.97**

MAB4-st
Set Of Wall Brackets For Arched
Type Towel Rail (Windsor)
White RAL 9016 W **£75.97**
Chrome C **£75.97**

RAL Colours

For Chelmsford Range only. Price on application for other models.

CLRAL
Any RAL Colour for Chelmsford
Arched or Chelmsford Straight
RAL Colour **£350.46**



Scan for more
on valves and
accessories

All prices ex. VAT



Terms of Delivery

Prices quoted are for UK Mainland only.

For other locations, please contact our Sales Office on +44 (0)1908 010333.

Do not book your plumber until the goods have been delivered and checked.

Date of delivery

For items in stock, a suitable delivery date should be arranged at time of order.

For out-of-stock items, an estimated delivery time will be advised at the time of order.

Please note that the estimated delivery date does not form part of the contract.

Time of delivery

Standard service is any time between 8am and 5pm. Timed deliveries can be made but at an extra cost.

In some instances it may be more convenient to have items delivered to a work address where someone is present to sign for them. In the unlikely event that the goods do not arrive before 5pm (for standard service, or for a timed delivery), please let us know the following or same day.

Meeting the delivery

Someone will need to be at the delivery address on the day of delivery.

Outside packaging should be inspected before signing the delivery note*.

If there is no-one available to sign for delivery, arrangements will be made to re-deliver at an additional cost to the customer.

*If parcels are damaged or have been tampered with in any way they should not be signed for unless marked 'DAMAGED' or 'SHORT DELIVERED'.

No claim for damage in transit or shortage will be accepted if signed for 'RECEIVED IN GOOD CONDITION' or 'UNCHECKED' or 'NOT EXAMINED'.

Please note that, due to Health and Safety legislation, the driver is only allowed to deliver radiators to the nearest hard standing (pavement or driveway) and is not required to carry the radiators up any steps.

Where a radiator is over 25KG in weight, please ensure someone is available at the delivery address to assist the driver.

Within 24 hours of receiving radiators, please unwrap and thoroughly inspect goods. Any visible fault or imperfection (or missing parts) must be reported to Ultraheat or in the case this has been purchased from a reseller, please contact them directly within one working day (24 hours) of receipt to enable us to send a replacement, otherwise goods shall be deemed to be acceptable.

A contents sheet will be enclosed in the box with the radiator to enable you to check that all parts are present.

In the unlikely event that your radiator is visibly faulty, please ensure that you retain all the original packaging. We cannot accept returned radiators on the grounds of visible damage or visible fault if it has been plumbed in.

Pipe centres

If you require measurements, please call our sales office or refer to our website: www.ultraheat.co.uk

Pipe centre measurements and other measurements may have higher variance in Stainless Steel products as they are hand made, therefore you are advised to erect your pipes after you have received the radiator.

Pipe centre measurements are incorporating pair of valve distance of 45mm each to total of 90mm where applicable.

We recommend delivery and receipt of product before positioning pipework.

BTU Heat Output

Heat Output (BTU/Watt) quoted is based on Delta T50 (Δ) and may vary depending on colour and finish of radiator.

Where multiple finishes are available, heat outputs are stated for painted finishes; for chrome finishes in these ranges, quoted heat outputs should be reduced by 20%. Please enquire for more details.

For full terms and conditions

Please visit www.ultraheat.co.uk

ULTRAHEAT Terms and Conditions

The Buyer's attention is in particular drawn to the provisions of condition 10.

1. Interpretation
- 1.1 The definitions and rules of interpretation in this condition apply in these conditions.
- 1.2 Buyer: the person, firm or company who purchases the Goods from the Seller.
- 1.3 Contract: any contract between the Seller and the Buyer for the sale and purchase of the Goods, incorporating these conditions.
- 1.4 Delivery Point: the place where delivery of the Goods is to take place under condition 4.
- 1.5 Goods: any goods agreed in the Contract to be supplied to the Buyer by the Seller (including any part or parts of them).
- 1.6 Seller: Pitcas Limited trading as Ultraheat, Aeon, or TIME, TIME Cables, TIME LED, TIME Cable Clips, TIME Panel Light, etc as well as trading as TIME (registered in England and Wales with company number 02505544).
- 1.7 Specification: any specification for the Goods, including any related plans and drawings, that is agreed by the Buyer and the Seller.
- 1.8 Words in the singular include the plural and in the plural include the singular.
- 1.9 A reference to one gender includes a reference to the other gender.
- 1.10 Condition headings do not affect the interpretation of these conditions.
- 1.11 A reference to a statute or statutory provision is a reference to such statute or provision as amended or re-enacted. A reference to a statute or statutory provision includes any subordinate legislation made under that statute or statutory provision, as amended or re-enacted.
- 1.12 Any phrase introduced by the terms including, in particular, in similar expression shall be construed as illustrative and shall not limit the sense of the words preceding those terms.
- 1.13 A reference to writing or written includes faxes and e-mails.

2. Application of these conditions
- 2.1 Subject to any variation under condition 2.3 the Contract shall be on these conditions to the exclusion of all other terms and conditions (including any terms or conditions which the Buyer purports to apply under any purchase order, confirmation of order, Specification or other document) or which are implied by trade, custom or course of dealing.
- 2.2 No terms or conditions endorsed on, delivered with or contained in the Buyer's purchase order, form of order, Specification or other document shall form part of the Contract simply as a result of such document being referred to in the Contract.
- 2.3 These conditions apply to all the Seller's sales and any variation to these conditions and any representations about the Goods shall have no effect unless expressly agreed in writing and signed by a director of the Seller. The Buyer acknowledges that it has not relied on any statement, promise or representation made or given by or on behalf of the Seller which is not set out in the Contract. Nothing in this condition shall exclude or limit the Seller's liability for fraudulent misrepresentation.
- 2.4 Each order or acceptance of a quotation for Goods by the Buyer from the Seller shall be deemed to be an offer by the Buyer to buy Goods subject to these conditions.
- 2.5 No order placed by the Buyer shall be deemed to be accepted by the Seller until a written acknowledgement of order is issued by the Seller (or if earlier) the Seller delivers the Goods to the Buyer.
- 2.6 The Buyer shall ensure that the terms of its order and any applicable Specification are complete and accurate.
- 2.7 Any quotation is given on the basis that no Contract shall come into existence until the Seller despatches an acknowledgement of order to the Buyer (or if earlier) the Seller delivers the Goods to the Buyer. Any quotation is valid for a period of 30 days only from its date, provided that the Seller has not previously withdrawn it.

3. Description
- 3.1 The quantity and description of the Goods shall be as set out in the Seller's quotation or acknowledgement of order.
- 3.2 All samples, drawings, descriptive matter, Specifications and advertising issued by the Seller and any descriptions or illustrations contained in the Seller's catalogues or brochures are issued or published for the sole purpose of giving an approximate idea of the Goods described in them. They shall not form part of the Contract and no sale is a sale by sample.
- 3.3 To the extent that the Goods are to be manufactured in accordance with a Specification supplied by the Buyer, the Buyer shall indemnify the Seller against all liabilities, costs, expenses, damages and losses (including any direct, indirect or consequential losses, loss of profit, loss of reputation and all interest, penalties and legal and other professional costs and expenses) suffered or incurred by the Seller in connection with any claim made against the Seller for actual or alleged infringement of a third party's intellectual property rights arising out of or in connection with the Seller's use of the Specification. This condition 3.3 shall survive termination of the Contract.
- 3.4 The Seller reserves the right to amend the Specification if required by any applicable statutory or regulatory requirements. If such amendments will materially change the nature or quality of the Goods, the Seller shall notify the Buyer who may then terminate the Contract.

4. Delivery
- 4.1 Unless otherwise agreed in writing by the Seller, delivery of the Goods shall take place at the Seller's place of business.
- 4.2 Delivery is completed on the completion of loading of the Goods at the Delivery Point.
- 4.3 The Buyer shall take delivery of the Goods within 10 days of the Seller giving notice that the Goods are ready for delivery.
- 4.4 Any dates specified by the Seller for delivery of the Goods are intended to be an estimate (and not of the essence) and time for delivery shall not be made of the essence by notice. If no dates are so specified, delivery shall be within a reasonable time.
- 4.5 Subject to the other provisions of these conditions, the Seller shall not be liable for any direct, indirect or consequential loss (all three of which terms include, without limitation, pure economic loss, loss of profits, loss of business, depletion of goodwill and similar losses), costs, damages, charges or expenses caused directly or indirectly by any delay in the delivery of the Goods (even if caused by the Seller's negligence), nor shall any delay entitle the Buyer to terminate or rescind the Contract unless such delay exceeds 180 days.
- 4.6 If for any reason the Buyer fails to take or accept delivery of any of the Goods within 10 days of the Seller giving it notice that the Goods are ready for delivery, or the Seller is unable to deliver the Goods on time because the Buyer has not provided appropriate instructions, documents, licences or authorisations:

- (a) risk in the Goods shall pass to the Buyer (including for loss or damage caused by the Seller's negligence);
- (b) the Goods shall be deemed to have been delivered at 9.00 am on the tenth day after the day on which the Seller notified the Buyer that the Goods were ready for delivery; and
- (c) the Seller may store the Goods until delivery, whereupon the Buyer shall be liable for all related costs and expenses (including, without limitation, storage and insurance).
- 4.7 If 10 days after the day on which the Seller notified the Buyer that the Goods were ready for delivery the Buyer has not taken or accepted delivery of them, the Seller may, as an alternative or in addition to its rights under condition 4.6(c), resell or otherwise dispose of part or all of the Goods and, after deducting reasonable storage and selling costs, account to the Buyer for any excess over the price of the Goods or charge the Buyer for any shortfall below the price of the Goods.
- 4.8 The Buyer shall provide at the Delivery Point and at its expense adequate and appropriate equipment and manual labour for loading of the Goods. The Seller's delivery personnel shall not be required to: (a) deliver Goods to any place at the Delivery Point beyond the ground level hard surface nearest to the Seller's vehicle; nor
- (b) carry Goods up steps.
- 4.9 The Seller may deliver the Goods by separate instalments. Each separate instalment shall be invoiced and paid for in accordance with the provisions of the Contract. Any delay in delivery or defect in an instalment shall not entitle the Buyer to cancel any other instalment.
- 4.10 Each instalment shall be a separate Contract and no cancellation or termination of any one Contract relating to an instalment shall entitle the Buyer to repudiate or cancel any other Contract or instalment.
- 4.11 Unless the Buyer has ordered and paid for a special timed delivery at a time and place agreed by the Seller, the time of delivery shall be at any time on the date of delivery between 8am and 5pm.

- 4.12 The Buyer or its representative shall attend at the Delivery Point on the date and at the time of delivery and shall:
 - (a) forthwith inspect the outside of all packages before signing the delivery note on which note the inspector shall record all and any damage or short delivery; and
 - (b) within 24 hours of delivery:
 - (i) unpack and thoroughly inspect the Goods received; and
 - (ii) check the Goods received against the Goods ordered; and
 - (iii) report forthwith to the Seller any visible faults or imperfections and any missing Goods or parts thereof; and
 - (c) retain the packaging and delivery documentation of any faulty or imperfect Goods for inspection by the Seller; and
 - (d) not install, adapt, sell or dispose of (nor permit any other person to install, adapt, sell or dispose of) any Goods which the Buyer and/or the person inspecting the delivered Goods has found to be faulty, imperfect or incomplete.

5. Non-delivery
- 5.1 The quantity of any consignment of Goods as recorded by the Seller on despatch from the Seller's place of business shall be conclusive evidence of the quantity received by the Buyer on delivery unless the Buyer can provide conclusive evidence proving the contrary.
- 5.2 The Seller shall not be liable for any non-delivery of Goods (even if caused by the Seller's negligence) unless the Buyer gives written notice to the Seller of the non-delivery within 4 days of the date when the Goods would in the ordinary course of events have been received.
- 5.3 Any liability of the Seller for non-delivery of the Goods shall be limited to replacing the Goods within a reasonable time or issuing a credit note at the pro rata contract rate against any invoice raised for such Goods.

6. Risk/title
- 6.1 The Goods are at the risk of the Buyer from the time of delivery.
- 6.2 All Goods supplied by the Seller free of charge remain at all times the property of the Seller unless and until the Seller has agreed in writing to sell such Goods to the Buyer and has received payment in full in accordance with sub-condition 6.3 below. Samples supplied by the Seller free of charge may be used for display purposes only and shall be returned (at the Buyer's expense) to the Seller complete and in saleable condition within 3 months of delivery unless a longer period has been agreed in writing by the Seller.
- 6.3 Ownership of the Goods shall not pass to the Buyer until the Seller has received in full (in cash or cleared funds) all sums due to it in respect of:
 - (a) the Goods; and
 - (b) all other sums which are or which become due to the Seller from the Buyer on any account.
- 6.4 Until ownership of the Goods has passed to the Buyer, the Buyer shall:

- (a) hold the Goods on a fiduciary basis as the Seller's bailee;
- (b) store the Goods (at no cost to the Seller) separately from all other goods of the Buyer or any third party in such a way that they remain readily identifiable as the Seller's property;
- (c) not destroy, deface or obscure any identifying mark or packaging on or relating to the Goods;
- (d) maintain the Goods in satisfactory condition and keep them insured on the Seller's behalf for their full price against all risks to the reasonable satisfaction of the Buyer from the date of delivery. On request the Buyer shall produce the policy of insurance to the Seller;
- (e) notify the Seller immediately if it becomes subject to any of the events listed in condition 6.6; and
- (f) give the Seller such information relating to the Goods as the Seller may require from time to time.
- 6.5 The Buyer may resell the Goods before ownership has passed to it solely on the following conditions:
 - (a) any sale shall be effected in the ordinary course of the Buyer's business at full market value;
 - (b) it does so as principal and not as the Seller's agent; and
 - (c) ownership of the Goods shall pass from the Seller to the Buyer immediately before the time at which resale by the Buyer occurs.
- 6.6 The Buyer's right to possession of the Goods shall terminate immediately if:
 - (a) the Buyer has a bankruptcy order made against him or makes an arrangement or composition with his creditors, or otherwise takes the benefit of any statutory provision for the time being in force for the relief of insolvent debtors, or (being a body corporate) convenes a meeting of creditors (whether formal or informal), or enters into liquidation (whether voluntary or compulsory) except a solvent voluntary liquidation for the purpose only of reconstruction or amalgamation, or has a receiver and/or manager, administrator or administrative receiver appointed to its undertaking or any part thereof, or documents are filed with the court for the appointment of an administrator of the Buyer or notice of intention to appoint an administrator is given by the Buyer or its directors or by a qualifying floating charge holder as defined in paragraph 14 of Schedule B1 to the Insolvency Act 1986), or a resolution is passed or a petition presented to any court for the winding-up of the Buyer or for the granting of an administration order in respect of the Buyer, or any proceedings are commenced relating to the insolvency or possible insolvency of the Buyer; or
 - (b) the Buyer sues or allows any execution, whether legal or equitable, to be levied on his/its property or obtained against him/it, or fails to observe or perform any of his/its obligations under the Contract or any other contract between the Seller and the Buyer; or is unable to pay its debts within the meaning of section 123 of the Insolvency Act 1986 or the Buyer ceases to trade; or
 - (c) the Buyer encounters or in any way incurs any of the Goods.
- 6.7 If, after ownership of the Goods passes to the Buyer, the Buyer shall be deemed subject to any of the events listed in condition 6.6, then, without limiting any other right or remedy the Seller may have:
 - (a) the Buyer's right to resell the Goods or use them in the ordinary course of its business ceases immediately; and
 - (b) the Seller may at any time:
 - (i) require the Buyer to deliver up all Goods in its possession that have not been resold, or irrevocably incorporated into another product; and
 - (ii) if the Buyer fails to do so promptly, enter any premises of the Buyer or of any third party where the Goods are stored in order to recover them.
- 6.8 The Seller shall be entitled to recover payment for the Goods notwithstanding that ownership of the Goods has passed to the Buyer. The Seller shall be deemed to have sold all goods of the Buyer. The Buyer grants the Seller its agents and employees an irrevocable licence at any time to enter any premises where the Goods are or may be stored in order to inspect them, or, where the Buyer's right to possession has terminated, to recover them.
- 6.9 Where the Seller is unable to determine whether any Goods are the goods in respect of which the Seller has a right to recover payment, the Seller shall be deemed to have sold all goods of the kind sold by the Seller to the Buyer in the order in which they were invoiced to the Buyer.
- 6.11 On termination of the Contract, however caused, the Seller's (but not the Buyer's) rights contained in this condition 6 shall remain in effect.

7. Price
- 7.1 Unless otherwise agreed by the Seller in writing, the price for the Goods shall be the price set out in the Seller's price list published on the date of delivery or deemed delivery.
- 7.2 The price for the Goods shall be:
 - (a) exclusive of any value added tax (VAT), which the Buyer shall additionally be liable to pay to the Seller at the prevailing rate, subject to the receipt of a valid VAT invoice; and
 - (b) exclusive of all costs or charges in relation to packaging, loading, unloading, carriage and insurance, all of which amounts the Buyer shall pay in addition when it is due to pay for the Goods provided that in respect of Goods delivered within Great Britain the price of Goods shall include:
 - (i) packaging, loading, unloading, and an element of insurance cover (for details of which respect please contact the Seller); and
 - (ii) (for each order that is confirmed by the Seller to exceed its minimum order quantity in which cover that product type and delivery destination) the cost of carriage.
- 7.3 The Seller may, by giving notice to the Buyer at any time before delivery, increase the price of the Goods to reflect any increase in the cost of the Goods that is due to:
 - (a) any request by the Buyer to change the delivery date(s), quantities or types of Goods ordered, or the Specification; or
 - (b) any delay caused by any instructions of the Buyer or failure of the Buyer to give the Seller adequate or accurate information or instructions.

8. Payment
- 8.1 Unless otherwise agreed, the Buyer shall pay the full price for the Goods in pounds sterling (GBP) or other currency as indicated on the invoice or proforma at the time of placing its order with the Seller. Any payment deferral, credit, return or prompt payment discount terms granted to the Buyer by the Seller may be changed or cancelled at any time.
- 8.2 Subject to condition 8.4, a payment on full balance of the price for the Goods is due in pounds sterling on the due date as stated on the invoice.
- 8.3 Time for payment shall be of the essence.
- 8.4 No payment shall be deemed to have been received until the Seller has received cleared funds.
- 8.5 All payments payable to the Seller under the Contract shall become due immediately on its termination, without any other provision.
- 8.6 The Buyer shall make all payments due under the Contract in full without any deduction whether by way of set-off, counterclaim, discount, abatement or otherwise unless the Buyer has a valid court order requiring an amount equal to such deduction to be paid by the Seller to the Buyer. The Seller may at any time, without limiting any other rights or remedies it may have, set-off any amount owing to it by the Buyer against any amount payable by the Seller to the Buyer.
- 8.7 If the Buyer fails to pay the Seller any sum due pursuant to the Contract, the Buyer shall be liable to pay interest to the Seller on such sum from the due date for payment at the annual rate of 4% above the base lending rate from time to time of Barclays Bank, accruing on a daily basis until payment is made, whether before or after any judgment. The Buyer shall pay the interest together with the overdue amount. The Seller reserves the right to elect to claim interest and late payment compensation under the Late Payment of Commercial Debts (Interest) Act 1998.
- 8.8 Should the Seller be required to enforce the terms of the Contract against the Buyer (including, without limitation, to recover the price of the Goods) then the Buyer will indemnify the Seller against all costs and expenses (including professional and legal costs and expenses on a full indemnity basis suffered or incurred by the Seller arising out of or in connection with the Seller enforcing the terms of the Contract).

9. Quality
- 9.1 Where the Seller is not the manufacturer of the Goods, the Seller shall endeavour to transfer to the Buyer the benefit of any warranty or guarantee given to the Seller.
- 9.2 The Seller warrants that (subject to the other provisions of these conditions):
 - (a) on delivery, and for a period of 12 months from the date of delivery (Warranty Period), the Goods shall: conform in all material respects with their description and any applicable Specification;
 - (b) be free from material defects in design, material and workmanship;
 - (c) be of satisfactory quality within the meaning of the Sale of Goods Act 1979; and
 - (d) be reasonably fit for any particular purpose for which the Goods are being bought if the Buyer had made known that purpose to the Seller in writing and the Seller has confirmed in writing that it is reasonable for the Buyer to rely on the skill and judgement of the Seller; and
 - (e) on delivery, the products shall be free from material defects resulting from faulty manufacture or workmanship; for the following periods:
 - (i) Electrical only or dual fuel radiators and towel rails: 12 months
 - (ii) LED lamps, fittings and associated accessories: 1, 2, 3 or 5 years, as stated in the literature provided with the product at the point of sale.
 - (iii) LED Light Panels: 3 or 5 years, as stated in the literature provided with the product at the point of sale, Water Treatment Products: Mappette Filter and Electrolyte Scale Remover: 2 years
 - (f) on delivery, and for a period of 5 years from the date of delivery, Ultraheat Premier Range, (excluding Goods falling within the foregoing condition 9.2(b)) shall be free from material defects resulting from faulty manufacture or workmanship; and
 - (g) on delivery, and for a period of 10 years from the date of delivery, Ultraheat Contact 4, and Ultraheat Premier Aluminium radiators (including Goods falling within the foregoing conditions 9.2(b) or (c)) shall be free from material defects resulting from faulty manufacture or workmanship; and
 - (h) on delivery, and for a period of 20 years from the date of delivery, conditional warranty on Aeon Stainless steel products (excluding Goods falling within the foregoing conditions 9.2(b), (c) or (d)) shall be free from leakage resulting from material defects due to faulty manufacture or workmanship. (Conditional means we would need to be informed if the system is an open system that is fed by mains water or direct hot water cylinder).
- (f) on delivery, and for a period of 10 years from the date of delivery, conditional warranty on Aeon Aluminium products (excluding Goods falling within the foregoing conditions 9.2(b), (c), (d) or (e)) shall be free from leakage resulting from material defects due to faulty manufacture or workmanship. (Conditional means we would need to be informed if the system is an open system that is fed by mains water or direct hot water cylinder).
- 9.3 The Seller shall not be liable for a breach of any of the warranties in condition 9.2 unless:
 - (a) the Buyer has complied with its obligations under these terms and conditions, in particular (without limitation) the Buyer's obligations pursuant to condition 4.12 above to inspect all Goods upon and immediately following delivery and notify the Seller promptly and in full of faulty, imperfect or incomplete Goods; and
 - (b) the Buyer gives written notice of the defect to the Seller during the applicable warranty period set out in condition 9.2 within a reasonable time of discovery that some or all of the Goods do not comply with the warranties in condition 9.2, and, if the defect is as a result of damage in transit to the carrier, within 3 days of the time when the Buyer discovers or ought to have discovered the defect; and
 - (c) the Seller gives a reasonable opportunity after receiving the notice of examining such Goods at the Seller's (if asked to do so by the Seller) returns such Goods to the Seller's place of business at the Seller's cost for the examination to take place there.
- 9.4 The Seller shall not be liable for a breach of any of the warranties in condition 9.2 if:
 - (a) the Buyer makes any further use of such Goods after giving such notice; or
 - (b) the defect arises because the Buyer failed to follow the Seller's oral or written instructions as to the storage, installation, commissioning, use or maintenance of the Goods or (if there are none)

- (g) good trade practice; or
- (h) the serial numbers on the Goods have been removed, erased, concealed or for any other reason are unavailable; or
- (i) no question arises in whole or in part from competent wear and tear, wilful damage, negligence or abnormal storage or working conditions; or
- (j) the Goods have not been installed with reasonable competence and in accordance with the best industry standards in the UK for professional installation of heating and plumbing goods; or
- (k) the Buyer alters or repairs such Goods without the written consent of the Seller; or
- (l) the breach arises as a result of the Seller following any drawing, design or Specification supplied by the Buyer; or
- (m) the Goods differ from their description or the Specification as a result of changes made to ensure they comply with applicable statutory or regulatory requirements.
- 9.5 Subject to condition 9.3 and condition 9.4, if any of the Goods do not conform with either of the warranties in condition 9.2 the Seller shall at its option repair or replace such Goods (or the defective part) or refund the price of such Goods at the pro rata contract rate provided that, if the Seller so requests, the Buyer shall, at the Seller's expense, return the Goods or the part of such Goods which is defective to the Seller.
- 9.6 If the Seller complies with condition 9.5 it shall have no further liability for a breach of any of the warranties in condition 9.2 in respect of such Goods.
- 9.7 Any Goods replaced shall belong to the Seller and any repaired or replacement Goods shall be guaranteed on these terms for the unexpired portion of the applicable warranty period set out in condition 9.2.
- 9.8 The terms implied by sections 13 to 15 of the Sale of Goods Act 1979 are, to the fullest extent permitted by law, excluded from the Contract.
- 9.9 These conditions shall apply to any repaired or replacement Goods supplied by the Seller.
10. Limitation of liability
- 10.1 Subject to condition 4, condition 5 and condition 9, the following provisions set out the entire financial liability of the Seller (including any liability for the acts or omissions of its employees, agents and sub-contractors) to the Buyer in respect of:
 - (a) any breach of these conditions;
 - (b) any use made or resale by the Buyer of any of the Goods, or of any product incorporating any of the Goods; and
 - (c) any representation, statement or tortious act or omission including negligence arising under or in connection with the Contract.
- 10.2 All warranties, conditions and other terms implied by statute or common law (save for the conditions implied by section 12 of the Sale of Goods Act 1979) are, to the fullest extent permitted by law, excluded from the Contract.
- 10.3 Nothing in these conditions excludes or limits the liability of the Seller:
 - (a) for death or personal injury caused by the Seller's negligence, or the negligence of its employees, agents or sub-contractors; or
 - (b) under section 2(3) of the Consumer Protection Act 1987; or
 - (c) for any matter which would be illegal for the Seller to exclude or attempt to exclude its liability; or
 - (d) for fraud or fraudulent misrepresentation.
- 10.4 Subject to condition 10.2 and condition 10.3:
 - (a) the Seller's total liability in contract, tort (including negligence or breach of statutory duty), misrepresentation, restitution or otherwise, arising in connection with the performance or contemplated performance of the Contract shall be limited to the Contract price; and
 - (b) the Seller shall not be liable to the Buyer for indirect or consequential loss of profit or loss of business which arise out of or in connection with the Contract, whether in contract, tort (including negligence), breach of statutory duty, or otherwise.
- 10.5 The Buyer acknowledges and agrees that it is a business customer by virtue of the Goods being received by it for business purposes.
- 10.6 The Buyer acknowledges and agrees that:
 - (a) it has read and fully understood the limitations and exclusions of the obligations and liabilities of the Seller set out in these conditions;
 - (b) it has freely agreed to them;
 - (c) it has not been induced or coerced into the basis for setting the price of the Goods;
 - (d) it has freely accepted the risks associated with them; and
 - (e) it is able to insure itself against all or some of those risks should it so desire.

11. Assignment
- 11.1 The Seller may at any time assign, transfer, mortgage, charge, sub-contract, declare a trust over or deal in any other manner with any or all of its rights or obligations under the Contract or any part of it to any person, firm or company.
- 11.2 The Buyer shall not be entitled to assign, transfer, mortgage, charge, sub-contract, declare a trust over or otherwise deal in any other manner with any or all of its rights or obligations under the Contract or any part of it without the prior written consent of the Seller.
12. Termination
- 12.1 Without limiting its other rights or remedies, the Seller may terminate the Contract with immediate effect by giving written notice to the Buyer if:
 - (a) the Buyer commits a material breach of any term of the Contract and (if such breach is remediable) fails to remedy that breach within 14 days of the Buyer being notified in writing to do so;
 - (b) the Buyer takes any step or action in connection with those events set out in condition 6.6;
 - (c) the Buyer suspends, threatens to suspend, ceases or threatens to cease to carry on all or a substantial part of its business; or
 - (d) the Buyer's financial position deteriorates to such an extent that in the Seller's opinion the Buyer's capability to adequately fulfil its obligations under the Contract has been placed in jeopardy.
- 12.2 Without limiting its other rights or remedies, the Seller may terminate the Contract with immediate effect by giving written notice to the Buyer if the Buyer fails to pay any amount due under the Contract on the due date for payment.
- 12.3 Termination of the Contract shall not affect any of the parties' rights and remedies that have accrued as at the date of termination, including the right to claim damages in respect of any breach of this Contract that existed at or before the date of termination.
- 12.4 Any provision of the Contract that expressly or by implication is intended to come into or continuation in force on or after termination shall remain in full force and effect.

13. Force majeure
- The Seller reserves the right to defer the date of delivery or to cancel the Contract or reduce the volume of the Goods ordered by the Buyer (without liability to the Buyer) if it is prevented from or delayed in the carrying on of its business due to circumstances beyond the reasonable able control of the Seller, including, without limitation, acts of God, governmental actions, war or national emergency, acts of terrorism, protests, riot, civil commotion, fire, explosion, flood, epidemic, lock-outs, strikes or other labour disputes (whether or not relating to either party's workforce), or restraints or delays affecting carriers or inability or delay in obtaining supplies of adequate or suitable materials, provided that, if the event in question continues for a continuous period in excess of 90 days, the Buyer shall be entitled to give notice in writing to the Seller to terminate the Contract.
14. Entire agreement
- The Contract constitutes the entire agreement between the parties and supersedes and extinguishes all previous agreements, promises, assurances, warranties, representations and understandings between them, whether written or oral, relating to its subject matter.
15. General
- 15.1 Each right or remedy of the Seller under the Contract is without prejudice to any other right or remedy of the Seller whether under the Contract or not.
- 15.2 If any provision or part-provision of the Contract is found by any court, tribunal or administrative body of competent jurisdiction to be wholly or partly illegal, invalid, void, voidable, unenforceable or unreasonable it shall to the extent of such illegality, invalidity, voidness, voidability, unenforceability or unreasonableness be deemed severable and the remaining provisions of the Contract and the remainder of such provision shall continue in full force and effect. In such circumstances, the parties shall negotiate in good faith to amend such provision or part-provision so that, as amended, it is legal, valid and enforceable and, to the greatest extent possible, achieves the intended commercial result of the original provision or part-provision.
- 15.3 Failure of or by the Seller in enforcing or partially enforcing any provision of the Contract shall not be construed as a waiver of any of its rights under the Contract, nor shall it prevent or restrict the further exercise of that or any other right or remedy.
- 15.4 Any waiver by the Seller of any breach of, or any default under, any provision of the Contract by the Buyer shall not be deemed a waiver of any subsequent breach or default and shall in no way affect the other terms of the Contract.
- 15.5 The parties to the Contract do not intend that any term of the Contract shall be enforceable by virtue of the Contracts (Rights of Third Parties) Act 1999 by any person that is not a party to it.
- 15.6 The formation, existence, continuation, performance, validity and all aspects of the Contract shall be governed by English law and the parties submit to the exclusive jurisdiction of the English courts in relation to the settlement of any dispute or claim (including non-contractual disputes or claims) arising out of or in connection with the Contract.

16. Communications
- 16.1 All communications between the parties about the Contract shall be in writing and delivered by hand or sent by pre-paid first class post or sent by fax or e-mail:
 - (a) in the case of communications to the Seller to its registered office or such changed address as shall be notified to the Buyer by the Seller; and
 - (b) (in the case of the communications to the Buyer) to the registered office of the addressee (if it is a company) or (in any other case) to any address of the Buyer set out in any document which forms part of the Contract or such other address as shall be notified to the Seller by the Buyer.
- 16.2 Communications shall be deemed to have been received:
 - (a) if sent by pre-paid first class post, two days (excluding Saturdays, Sundays and bank and public holidays) after posting (exclusive of the day of posting); or
 - (b) if delivered by hand, on the working day of delivery; or
 - (c) if sent by fax or e-mail on a working day prior to 4.00 pm, at the time of transmission and otherwise on the next working day.
- 16.3 In relation to the services, the Customer:
 - (a) agrees that Pitcas may from time to time monitor or record calls made to Pitcas or by Pitcas to improve customer service, and/or for training and marketing purposes.

Terms and conditions are available as a PDF file under request. Alternatively, they can be downloaded from our website.



Scan the QR code to receive a digital PDF
or to request additional print copies



Ultraheat is the heating division of Pitacs Limited

Bradbourne Point, Bradbourne Drive,
Tilbrook, Milton Keynes
Buckinghamshire, MK7 8AT
United Kingdom

T: +44 (0)1908 010333 F: +44 (0)1908 640017
E: heating-sales@pitacs.com
W: www.ultraheat.co.uk



5 056498 312441 >

UH-PREMCAT(GBP)-MAY22