



TERMA

SINCE 1990

CENÍK DESIGNOVÝCH A EL. RADIÁTORŮ
(PLATNÝ OD 2023.09.01)



Představení a poslání značky TERMA

Jsme dlouholetý výrobce koupelnových a designových radiátorů, topných tyčí, bezvýkopových zařízení protlakem, strojů na průtahy optických kabelů a rehabilitačních zařízení. S více než 30 lety zkušeností sloužíme lidem ve více než 50 zemích světa na 4 kontinentech. Naším závazkem je vždy poskytovat nejvyšší kvalitu našich výrobků, což je projevem našeho respektu k zákazníkovi, jehož spokojenost je naší nejvyšší prioritou. Plnění Vašeho očekávání nám nestačí – chceme je překonat. Víme, že udržitelný vývoj lze dosáhnout pouze při spolupráci s nejlepšími v oborech. Práce s odborníky a kreativními lidmi proto umožňuje dosáhnout inovativních a funkčních řešení. Jsme dokonalí? Ne. Snaha o dokonalost je nejsilnějším motorem našich aktivit.

Činnost společnosti stojí na hodnotách, které jsou společným základem pro všechny procesy, které provádíme. Inovace, pečlivost, zodpovědnost, šetrnost k životnímu prostředí a pokora jsou součástí našeho každodenního života. Spokojenost ostatních nás inspiruje k hledání nových možností, jak ulehčit lidem život ve všech lidských činnostech. I proto financujeme vývoj designových a funkčních rehabilitačních přístrojů pro rovnání skoliózy, navrácení lidí po úraze zpět do života a pro trvale handicapované vyrábíme přístroje pro každodenní pomoc a radost z pohybu. V souladu s podmínkami volného trhu chceme našim partnerům nabídnout plnou podporu a pomoc k úspěchu v jejich podnikání a nabídnout spotřebitelům ty nejlepší produkty v poměru cena/kvalita.

Katalogy, ceníky a jiné materiály, které vám dáváme, jsou výsledkem práce více než 700 lidí. Jsou to jejich znalosti, zkušenosti, odhodlání a vášně, které každým rokem přinášejí do světa tisíce radiátorů. Ne všechny modely jsou uvedeny v této publikaci, proto vždy hledejte Novinky na našich internetových stránkách a ptejte se Obchodních manažerů. Úzce spolupracujeme s předními designéry a inženýry, vytváříme trendy v současných designových topných produktech. Již řadu let jsme uznávaní spotřebiteli, ale také designéry a odbornými sdruženími, což se odráží v každoročních cenách, které dostáváme. Je to důležité? Nejdůležitějším faktorem kvality naší práce je vaše volba. Věříme, že ilustrace v katalogu nejen splňují vaše očekávání, ale překračují je. Očekáváme, že budete k nám ještě náročnější. Teprve potom se můžeme ještě zlepšit.

OBSAH

- 16 Barvy
- 29 Modely Skladem
- 31 Litinové radiátory
- 55 Designové a el. radiátory
- 281 Elektrické topné tyče
- 307 Ventily a příslušenství
- 337 Sanitární příslušenství
- 377 Všeobecné obchodní podmínky
- 382 Tabulka přepočtu
- 383 Legenda
- 395 Kontakt

LITINOVÉ RADIÁTORY



BART
RADIÁTOR VODNÍ
Bart 32



PLAIN
RADIÁTOR VODNÍ
Plain 43



BERGAMO
RADIÁTOR VODNÍ
Bergamo 34
ELEKTRICKÝ
Bergamo E 35

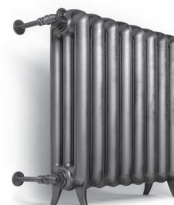

PLAIN 3K
RADIÁTOR VODNÍ
Plain 47



KASZUB
RADIÁTOR VODNÍ
Kaszub 36



PLAIN TOWEL RAIL
RADIÁTOR VODNÍ
Plain Towel Rail 51



OXFORD
RADIÁTOR VODNÍ
Oxford 40



**NOVINKA
STYLOS**
RADIÁTOR VODNÍ
Stylos 52

DESIGNOVÉ A KOUPELNOVÉ RADIÁTORY

Vodní - Elektrické - Kombinované

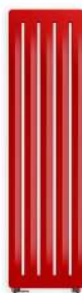

AERO V
RADIÁTOR VODNÍ
Aero V 56



ALEX
RADIÁTOR VODNÍ /
VODNĚ-ELEKTRICKÝ
Alex 59
Alex One 61
ELEKTRICKÝ
Alex E 60
Alex One E 62

VÝZNAM PÍSMEN V NÁZVECH RADIÁTORŮ

H - Horizontální
D - Dvouřadý nebo dvojité
V - Vertikální
One - Radiátor se zabudovanou topnou
tyčí One
M - Zrcadlo
DW - Dělicí stěna
E - Elektrický

AERO H

RADIÁTOR VODNÍ
Aero H 57
Aero HG 58



ANGUS H

RADIÁTOR VODNÍ /
VODNĚ-ELEKTRICKÝ
Angus H 67
ELEKTRICKÝ
Angus H E 68



ANGUS V

RADIÁTOR VODNÍ /
VODNĚ-ELEKTRICKÝ
Angus V 63
Angus DW 65
ELEKTRICKÝ
Angus V E 64
Angus DWE 66





NOVINKA
BOOKIE

RADIÁTOR VODNÍ
Bookie 69



CRYSTAL

RADIÁTOR VODNÍ /
VODNĚ-ELEKTRICKÝ
Crystal 87

ELEKTRICKÝ
Crystal E 88



FIONA

RADIÁTOR VODNÍ /
VODNĚ-ELEKTRICKÝ
Fiona 105
Fiona One 109

ELEKTRICKÝ
Fiona E 107
Fiona One E 111



BONE

RADIÁTOR VODNÍ /
VODNĚ-ELEKTRICKÝ
Bone 70
Bone DW 72
Bone One 73

ELEKTRICKÝ
Bone E 71
Bone DW E 72
Bone One E 74

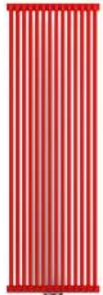

DELFIN

RADIÁTOR VODNÍ /
VODNĚ-ELEKTRICKÝ
Delfin 89

ELEKTRICKÝ
Delfin E 90



NOVINKA
FORTE

RADIÁTOR VODNÍ
Forte V10 113
Forte V20 114



CANE

RADIÁTOR VODNÍ /
VODNĚ-ELEKTRICKÝ
Cane 75

ELEKTRICKÝ
Cane E 76



DEXTER

RADIÁTOR VODNÍ /
VODNĚ-ELEKTRICKÝ
Dexter 91
Dexter One 93

ELEKTRICKÝ
Dexter E 92
Dexter One E 94



NOVINKA
GRID

RADIÁTOR VODNÍ /
VODNĚ-ELEKTRICKÝ
Grid 115

ELEKTRICKÝ
Grid E 116



CASE SLIM

RADIÁTOR VODNÍ /
VODNĚ-ELEKTRICKÝ
Case Slim 77

ELEKTRICKÝ
Case Slim E 79



DIAMOND

RADIÁTOR VODNÍ /
VODNĚ-ELEKTRICKÝ
Diamond 95

ELEKTRICKÝ
Diamond E 96



HEX

RADIÁTOR VODNÍ
Hex 117



CITY

RADIÁTOR VODNÍ /
VODNĚ-ELEKTRICKÝ
City 81
City One 83

ELEKTRICKÝ
City E 82
City One E 84



DOMI

RADIÁTOR VODNÍ /
VODNĚ-ELEKTRICKÝ
Domi 97

ELEKTRICKÝ
Domi E 98



INCORNER

RADIÁTOR VODNÍ /
VODNĚ-ELEKTRICKÝ
Incorner 118

ELEKTRICKÝ
Incorner E 119



CYKLON V

RADIÁTOR VODNÍ
Cyclon V 85

CYKLON H

RADIÁTOR VODNÍ
Cyclon H 86



EASY

RADIÁTOR VODNÍ /
VODNĚ-ELEKTRICKÝ
Easy 99
Easy DW 101
Easy One 103

ELEKTRICKÝ
Easy E 100
Easy DW E 102
Easy One E 104



INTRA

RADIÁTOR VODNÍ
Intra 120
Intra M 121



IRON D

RADIÁTOR VODNÍ /
VODNĚ-ELEKTRICKÝ
Iron D 122

ELEKTRICKÝ
Iron D E 124



MARLIN

RADIÁTOR VODNÍ /
VODNĚ-ELEKTRICKÝ
Marlin 145
Marlin One 147

ELEKTRICKÝ
Marlin E 146
Marlin One E 148



NOVINKA
PASSO HX

RADIÁTOR VODNÍ
Passo HX 162



IRON S

RADIÁTOR VODNÍ /
VODNĚ-ELEKTRICKÝ
Iron S 126

ELEKTRICKÝ
Iron S E 128



MICHELLE

RADIÁTOR VODNÍ /
VODNĚ-ELEKTRICKÝ
Michelle 149

ELEKTRICKÝ
Michelle E 151



NOVINKA
PASSO MH

RADIÁTOR VODNÍ
Passo MH 163



KIOTO

RADIÁTOR VODNÍ /
VODNĚ-ELEKTRICKÝ
Kioto 130
Kioto One 132

ELEKTRICKÝ
Kioto E 131
Kioto One E 133



MIKE

RADIÁTOR VODNÍ /
VODNĚ-ELEKTRICKÝ
Mike 152
Mike One 154

ELEKTRICKÝ
Mike E 153
Mike One E 155



PERŁA

RADIÁTOR VODNÍ
Perła 164

ELEKTRICKÝ
Perła E 165



LENA

RADIÁTOR VODNÍ /
VODNĚ-ELEKTRICKÝ
Lena 134

ELEKTRICKÝ
Lena E 136

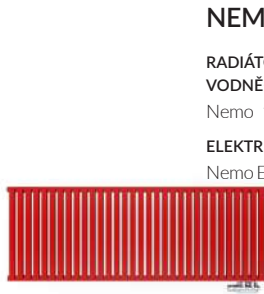

NEMO

RADIÁTOR VODNÍ /
VODNĚ-ELEKTRICKÝ
Nemo 156

ELEKTRICKÝ
Nemo E 157

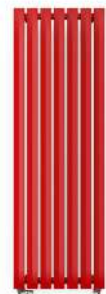

PIER

RADIÁTOR VODNÍ
Pier 166



LIMA

RADIÁTOR VODNÍ /
VODNĚ-ELEKTRICKÝ
Lima 138
Lima One 141

ELEKTRICKÝ
Lima E 140
Lima One E 142



OUTCORNER

RADIÁTOR VODNÍ /
VODNĚ-ELEKTRICKÝ
Outcorner 158

ELEKTRICKÝ
Outcorner E 159

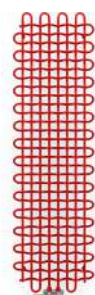

PLC V

RADIÁTOR VODNÍ
PLC V 167



LUKKA

RADIÁTOR VODNÍ /
VODNĚ-ELEKTRICKÝ
Lukka 143

ELEKTRICKÝ
Lukka E 144



PAJAŁ

RADIÁTOR VODNÍ /
VODNĚ-ELEKTRICKÝ
Pająk 160

ELEKTRICKÝ
Pająk E 161

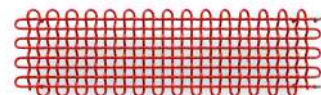

PLC H

RADIÁTOR VODNÍ
PLC H 168



POC 2

RADIÁTOR VODNÍ /
VODNĚ-ELEKTRICKÝ
POC 2 169

ELEKTRICKÝ
POC 2 E 170

RIBBON H

RADIÁTOR VODNÍ
Ribbon HSD 188
Ribbon HWS 189

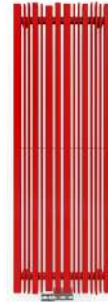

SHERWOOD V

RADIÁTOR VODNÍ /
VODNĚ-ELEKTRICKÝ
Sherwood V 200

ELEKTRICKÝ
Sherwood V E 201



POLA

RADIÁTOR VODNÍ /
VODNĚ-ELEKTRICKÝ
Pola 171
Pola One 173

ELEKTRICKÝ
Pola E 172
Pola One E 174



NOVINKA ROLO HANGER

RADIÁTOR VODNÍ/
VODNĚ-ELEKTRICKÝ
Rolo Hanger 190

ELEKTRICKÝ
Rolo Hanger E 191



SIMPLE

RADIÁTOR VODNÍ /
VODNĚ-ELEKTRICKÝ
Simple 202
Simple One 204
Simple DW 206

ELEKTRICKÝ
Simple E 203
Simple One E 205
Simple DW E 207



QUADRUS BOLD

RADIÁTOR VODNÍ /
VODNĚ-ELEKTRICKÝ
Quadrus Bold 175
Quadrus Bold One 177

ELEKTRICKÝ
Quadrus Bold E 176
Quadrus Bold One E 178



NOVINKA ROLO MIRROR

RADIÁTOR VODNÍ/
VODNĚ-ELEKTRICKÝ
Rolo Mirror 192

ELEKTRICKÝ
Rolo Mirror E 193



SPIRO

ELEKTRICKÝ
Spiro 208



QUADRUS SLIM

RADIÁTOR VODNÍ /
VODNĚ-ELEKTRICKÝ
Quadrus Slim 179
Quadrus Slim One 181

ELEKTRICKÝ
Quadrus Slim E 180
Quadrus Slim One E 182



ROLO ROOM

RADIÁTOR VODNÍ
Rolo Room 194
Rolo Room H 196

ELEKTRICKÝ
Rolo Room E 195

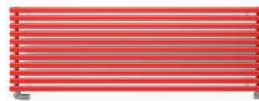

STAND

RADIÁTOR VODNÍ /
VODNĚ-ELEKTRICKÝ
Stand 209

ELEKTRICKÝ
Stand E 210



RETRO

RADIÁTOR VODNÍ /
VODNĚ-ELEKTRICKÝ
Retro 183
Retro S 185

ELEKTRICKÝ
Retro E 184

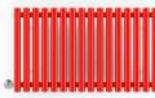

NOVINKA ROLO TOWEL

RADIÁTOR VODNÍ/
VODNĚ-ELEKTRICKÝ
Rolo Towel 197

ELEKTRICKÝ
Rolo Towel E 198



NOVINKA STEP

RADIÁTOR VODNÍ /
VODNĚ-ELEKTRICKÝ
Step 211

ELEKTRICKÝ
Step E 212



RIBBON V

RADIÁTOR VODNÍ
Ribbon V 186

ELEKTRICKÝ
Ribbon V E 187



SHERWOOD H

RADIÁTOR VODNÍ
Sherwood H 199



NOVINKA SWALE

RADIÁTOR VODNÍ
Swale 213



TRIGA

RADIÁTOR VODNÍ /
VODNĚ-ELEKTRICKÝ

ELEKTRICKÝ
Triga E 216
Triga M E 225

Triga 214
Triga M 224

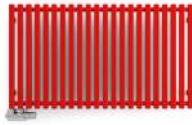

VIPERA

RADIÁTOR VODNÍ /
VODNĚ-ELEKTRICKÝ

Vipera 235
Vipera One 237

ELEKTRICKÝ
Vipera E 236
Vipera One E 238



ZIGZAG

RADIÁTOR VODNÍ /
VODNĚ-ELEKTRICKÝ

ZigZag 256

ELEKTRICKÝ
ZigZag E 257



TRIGA AN

RADIÁTOR VODNÍ

Triga AN 218
Triga ANC 220

ELEKTRICKÝ
Triga AN E 219
Triga ANCE 221



VIVO

RADIÁTOR VODNÍ /
VODNĚ-ELEKTRICKÝ

Vivo 239
Vivo One 241

ELEKTRICKÝ
Vivo E 240
Vivo One E 242



TRIGA AW

RADIÁTOR VODNÍ

Triga AW 222

ELEKTRICKÝ
Triga AW E 223



NOVINKA WARP ROOM

RADIÁTOR VODNÍ /
VODNĚ-ELEKTRICKÝ

Warp Room 243

ELEKTRICKÝ
Warp Room E 244



TUNE H

RADIÁTOR VODNÍ

Tune HSD 226



WARP S

RADIÁTOR VODNÍ /
VODNĚ-ELEKTRICKÝ

Warp S 245

ELEKTRICKÝ
Warp S E 246

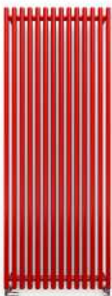

TUNE V

RADIÁTOR VODNÍ /
VODNĚ-ELEKTRICKÝ

Tune VWD 227
Tune VWS 229

ELEKTRICKÝ
Tune VWD E 228
Tune VWS E 230

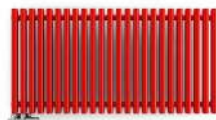

WARP T

RADIÁTOR VODNÍ /
VODNĚ-ELEKTRICKÝ

Warp T 247
Warp T One 249
Warp T Bold 251
Warp T Bold One 253

ELEKTRICKÝ
Warp T E 248
Warp T One E 250
Warp T Bold E 252
Warp T Bold One E 254



TYTUS

RADIÁTOR VODNÍ /
VODNĚ-ELEKTRICKÝ

Tytus 231
Tytus One 233

ELEKTRICKÝ
Tytus E 232
Tytus One E 234



NOVINKA WILLOW

RADIÁTOR VODNÍ

Willow 255

NOVINKY



BERGAMO 34



BOOKIE 69



CRYSTAL 87



FORTE 113



GRID 115



PASSO MH 163



ROLO HANGER 190



ROLO TOWEL 197



STEP 211



SWALE 213



WARP ROOM 243



WILLOW 255

SMART WI-FI



VOLTAN
262



VEO
263



SS1
264



VAZ
265



VTS
267



VOS
267

BLOWER



BLOWER
272



ALEX BLOWER
273



CITY BLOWER
273



FIONA BLOWER
274



LIMA BLOWER
274



MARLIN
BLOWER
275



POLA BLOWER
275



QUADRUS
BOLD BLOWER
276



QUADRUS
SLIM BLOWER
276



TYTUS BLOWER
277



WARP T
BLOWER
277



WARP T
BOLD BLOWER
278

ELEKTRICKÉ TOPNÉ TYČE



ONE
286



MOA IR
294



SIM
301



KTX 4 BLUE
288



MOA
295



Krytka SIM
302



KTX 4
289



DRY
296



TS1
303



KTX 3
290



TDY
297



TNK
303



KTX 2
291



MEG
298



TTIR1
304



KTX 1
292



REG 3
299



DTIR1
305



MOA BLUE
293



REG 2
300

VENTILY A PŘÍSLUŠENSTVÍ

POLIČKY, DRŽÁKY A HÁČKY NA RUČNÍKY

Police EASY	309
Police SIMPLE	309
Police STAND	310
Police BOOKIE	310
Police TRIGA	311
Police s držákem TRIGA	312
Držák TRIGA.....	313
Držák BELT.....	313
Háček bodový HANDY GRIP	314
Háček bodový HANDY VIP	314
Háček bodový KUKA.....	315
Háček bodový SPARK	315

SADY VENTILŮ

Sada Dexter regulační.....	323
Sada Dexter termostatická.....	324
Sada termostatická „Wood“	325
Sada rohová regulační	326
Sada rohová regulační Star	327
Sada rohová termostatická	328
Sada tříosová regulační	329
Sada tříosová termostatická	330
Sada tříosová term. s možností montáže topné tyče skrz ventil.....	331
Integrovaná sada termostatická.....	332
Sada komplexní integrovaný ventil s T- kusem s možností připojení topné tyče skrze ventil.....	333
Integrovaná sada termostatická s ponornou trubicí	334
Integrovaná sada uzavírací	335
Integrovaná sada termostatická TWINS.....	336
Integrovaná sada termostatická s ponornou trubicí UNICO ALL IN ONE	337
Sada tříosová termostatická INTEGRA.....	338
Sada tříosová termostatická VISION	339

Háček Yo!	316
Háček bodový ZIP H	316
Háček bodový ZIP V.....	317
Držák vyhnutý BASIC.....	317
Držák BASIC.....	318
Háček HAPPY HIPPO	318
Háček HAPPY RABBIT	319
Háček HAPPY SHARK.....	319
Háček SIMPLE.....	320
Držák CASE SLIM.....	320
Náhradní stoupačkový profil k radiátoru Michelle..	321
Náhradní stoupačkový profil k radiátoru Iron D, Iron S	321

Sada tříosová regulační VISION	340
Integrovaná sada uzavírací PREMIUM.....	341
Sada rohová termostatická ALL IN ONE.....	342
Sada krycí integrovaná	343
Sada rohová regulační „Classic Art“	344
Sada rohová regulační „Minimalist“.....	344
Sada rohová termostatická „Artistic“	345
Sada regulační termostatická „Wood“	345
Sada krycí dvojitá „Artistic“	346
Sada krycí dvojitá.....	346
Adaptér AL-PEX – 24 × 19	347
Adaptér ocel – 24 × 19	347
Adaptér měď – 24 × 19.....	348
Odvzdušňovací ventil	348
Redukce 5/4" x 1/2"	349
Zátka EUro 5/4"	349
Vsuvka pro spojení článků.....	349
Těsnění pro litinový radiátor.....	350
Montážní klíč na spojování článků	350
Hák.....	350

VENTILY A PŘÍSLUŠENSTVÍ

Komplexní integrovaný termostatický ventil s ponornou trubicí.....	352	Adaptér AL-PEX – 24 × 19	366
Komplexní integrovaný termostatický ventil přímý s ponornou trubicí.....	353	Adaptér AL-PEX – 3/4"	366
Komplexní integrovaný termostatický ventil..	354	Adaptér AL-PEX – M22 × 1,5	367
Komplexní integrovaný termostatický přímý	355	Adaptér měď – 24 × 19.....	367
Komplexní integrovaný ventil s T- kusem s možností připojení topné tyče skrze ventil	356	Adaptér měď – 3/4"	368
Ventil tříosý uzavírací integrovaný s T- kusem pro připojení topné tyče skrze ventil	357	Adaptér měď – M22 × 1,5	368
Ventil integrovaný uzavírací (VK)	358	Adaptér ocel – 24 × 19	369
Ventil tříosý termostatický	359	Adaptér ocel – M22 × 1,5.....	369
Ventil tříosý regulační	360	Termostatická hlavice ETNA.....	370
Ventil tříosý uzavírací	361	Termostatická hlavice NOBLE.....	370
Ventil rohový termostatický	361	Termostatická hlavice SLIM.....	371
Ventil rohový regulační.....	362	Zátka 7mm.....	371
Ventil rohový uzavírací.....	362	Zátka 3mm.....	372
Ventil termostatický přímý	363	Distanční matice	372
Ventil regulační přímý.....	363	Odvzdušňovací ventil	373
Ventil uzavírací přímý.....	364	Sada krycí dvojitá.....	373
T - KUS	364	Sada krycí integrovaná	374
Ventil regulační rohový Minimalist.....	365	Sada speciálních klíčů TERMA.....	374
Ventil regulační rohový Star	365	Prodlužovací trubice	375
		Čistící kartáč dlouhý	375
		Čistící kartáč Ribbon.....	375
		Sprchové sedátko DIS	376

INFORMACE

Všeobecné obchodní podmínky	377	Konstrukce kódu konfigurace radiátoru 385 – 393	
Tabulka přepočtu výkonu.....	382	Kontakt.....	395
Legenda	383	Otázky pro specifikaci radiátoru a tvoření.....	394
Výběr připravení otvorů pro připojení	384		

Barvy

Uvedené barvy se mohou mírně lišit od skutečných. Pro přesný výběr barev použijte originální vzorník, který je k dispozici u našich obchodních manažerů a prodejních partnerů.

VZORNÍK SPECIÁLNÍCH BAREV

Z PALETY BAREV RAL | RAL COLOURS
PALETTE | RAL FARBPALETTE NUAN-
CIER RAL | ПАЛИТРА ЦВЕТОВ

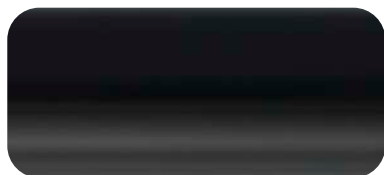

RAL 9005 Matt

9M5
KÓD



RAL 9005 Gloss

9P5

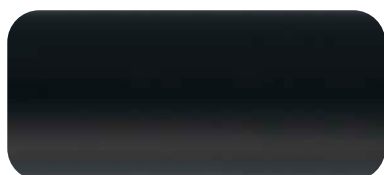

RAL 9005 Soft

S95



Anodic Black

ABC



Sterling

STE



Modern Grey

DGR



Inox

INO



Storm Sky

SSK



Winter Sky

WSK



Metallic Black

MBC



Sparkling Grey

RGY



Salt&Pepper

SPP

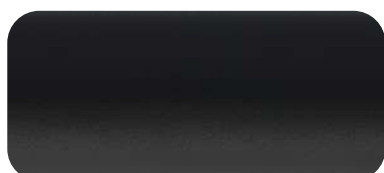

Heban

IHE

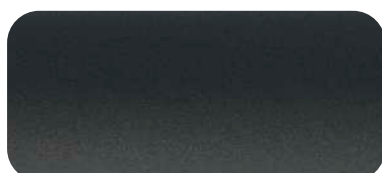

Metallic Grey

MGR



Diamond Silver

DIS



Magic Pearl

MPR



Granite

GRA



Silver Matt

SMA



Black Crocodile **BLN**



Graphite **GRP**



Nature **NAT**



Sparkling Gravel **RGR**



California Beige **ICB**



Anodic Gold **AGO**



Anodic Sapphire **ASP**



Blush **BUH**



Copper **COP**



Pastel Blue **PBL**



Soft 9016 **S96**



Bright Copper **BCO**



Blueberry **BLR**



White Wall **WWL**



Lotus **LOT**



Denim **DEM**



White Gold **WGD**



Sienna **SIA**



Green Chlorophyll **GCL**



Sparkling Cream **RCR**



Aubergine **ABG**



Soft Green Apple **SGA**



Quartz **QUA**



Anodic Brown **ABN**



Anodic Malachite **AMT**



Halo **HAL**



Dark Bronze **DRB**



Noble Brown **INB**



Metallic Silver **MSI**



Groovy Red **GRR**



Vibrant Brown **OVB**



Metallic Beige **MBE**



Metallic Red **MRE**



Metallic Stone **MST**



Lavender **LAV**



Soft 3028 **S38**



Chrom **CRO**

GALVANICKÁ POVRCHOVÁ ÚPRAVA

Radiátory i v Chromu: ALEX, BONE, DEXTER, DIAMOND, DOMI, EASY, FIONA, INTRA, LENA, LIMA, MARLIN, MICHELLE, MIKE, PERŁA, POLA, RETRO, SIMPLE, SPIRO, VIVO, ZIGZAG.



Raw copper **MIE**

RAW COPPER

Barevná varianta dostupná pouze pro Pajak a Pajak E. Vzhledem ke svým vlastnostem může povrch časem změnit barvu, ztmavnout.

VZORNÍK BAREV PREMIUM



Bottle Green

BGR



Champagne

CPG



Red Wine

RWE



Midnight

MDN



Pers

PER

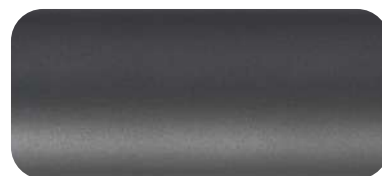

Raw Metal

RAW



Brushed Brass

BBS



Old Bronze

OBZ



Metal Alive

MAV



Brass

BRA



True Copper Bright

TCG



Silver

SVR

Barvy PREMIUM jsou s příplatkem 25% i z důvodu dražší technologie lakování.

Možné jsou na všechny radiátory TERMA, topné tyče ONE a ventily ALL IN ONE kromě:

BERGAMO, CASE SLIM, DELFIN, IRON D A S, KIOTO, NEMO, QUADRUS BOLD, VŠECHNY RIBBON, TUNE VWD, TUNE HSD, TRP, TYTUS, VOLTAN, WARP S, WARP T BOLD, WARP ROOM, WILLOW.

POZOR: Barva Brushed Brass nelze aplikovat na modely ANGUS, CANE, HEX, PLC, TRP, všechny TRIGA a SHERWOOD.

SPECIÁLNÍ NÁTĚRY

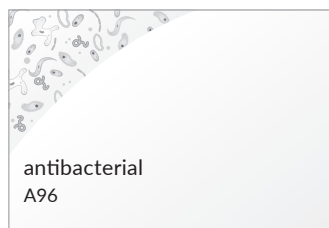

Je bílý antibakteriální finální nátěr (RAL 9016). Obsahuje molekuly stříbra. Uvolňující se ionty stříbra ničí bakterie a brání růstu plísní a hub. Použití tohoto nátěru je doporučeno hlavně pro výrobky v sanitárních místnostech, potravinářských a zdravotnických provozech. Cena radiátoru při zvolení antibakteriálního nátěru je +25% k ceně v obrázkovém ceníku ve sloupci Barvy RAL a speciální barvy.

VZORNÍK ÚPRAV PRO LITINOVÉ RADIÁTORY

Kromě standardních 190 barev RAL SKUPINA 1 (nanášených ponorným máčením) nabízíme řadu speciálních barev a řadu povrchových dekorativních úprav. Na přání zákazníka provádíme povrchovou úpravu radiátorů a příslušenství dle individuálních požadavků.

SKUPINA 1



White Soft

WS3



Frost

FR3



Metallic Brown

AB3



Autumn

AU3



Evening Garden

EG3



Shadow Gold

SG3



Graff

GR3



Flat Black

FB3



Raw Metal

ZE3



Metal Alive

ZE1



Paleta RAL

SKUPINA 2



Antique Copper

AC5



Antique Brass

AN5



Full Burnish

FB2



Bottle Green

BGR



Shaded Burnish

FB4



Midnight

MDN



Red Wine

RWE

SKUPINA 3



Ornament Gold*

GR7



Ornament Silver*

GR9



Ornament Copper*

GR8



Galvanic Copper

GC5



Polished Metal

ZE2

* Plocha může být provedena v libovolné barvě ze SKUPINY 1 Vzorníku pro litinové radiátory a vystouplé ornamenty ručně malované mohou být zlaté, stříbrné nebo měděné.

BARVY PRO RADIÁTOR BERGAMO

Dostupný v níže uvedených TERMA speciálních barvách + ve všech RAL uvedených na následujících stránkách.



Metallic Black

MBC

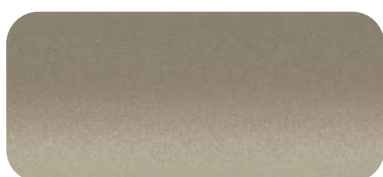

California Beige

ICB



Vibrant Brown

OVB

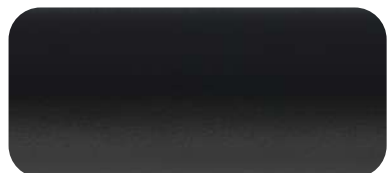

Heban

IHE



White Gold

WGD



Metallic Stone

MST

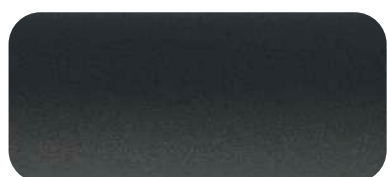

Metallic Grey

MGR



White Wall

WWL



Metallic Beige

MBE



Graphite

GRP



White Matt

WMA



Metallic Red

MRE



Salt&Pepper

SPP



Quartz

QUA



Anthracite

ANT



Metallic Silver

MSI



Noble Brown

INB



Modern Grey

DGR

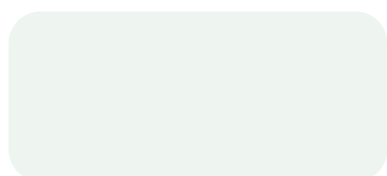

RAL 9016

916

RAL 9016 jen pro 10 článkový radiátor Bergamo

VZORNÍK BAREV RAL (75% LESKU)



RAL 1000 **100**
MAT A00 | SOFT S10



RAL 1007 **107**
MAT A07 | SOFT S17



RAL 1017 **117**
MAT A17 | SOFT S07



RAL 1027 **127**
MAT A27 | SOFT R17



RAL 1001 **101**
MAT A01 | SOFT S11



RAL 1011 **111**
MAT A11 | SOFT S01



RAL 1018 **118**
MAT A18 | SOFT S08



RAL 1028 **128**
MAT A28 | SOFT R18



RAL 1002 **102**
MAT A02 | SOFT S12



RAL 1012 **112**
MAT A12 | SOFT S02



RAL 1019 **119**
MAT A19 | SOFT S19



RAL 1032 **132**
MAT A32 | SOFT R12



RAL 1003 **103**
MAT A03 | SOFT S03



RAL 1013 **113**
MAT A13 | SOFT R13



RAL 1020 **120**
MAT A20 | SOFT R10



RAL 1033 **133**
MAT A33 | SOFT R03



RAL 1004 **104**
MAT A04 | SOFT S14



RAL 1014 **114**
MAT A14 | SOFT S04



RAL 1021 **121**
MAT A21 | SOFT R11



RAL 1034 **134**
MAT A34 | SOFT R04



RAL 1005 **105**
MAT A05 | SOFT S15



RAL 1015 **115**
MAT A15 | SOFT S05



RAL 1023 **123**
MAT A23 | SOFT S13



RAL 1037 **137**
MAT A37 | SOFT R07



RAL 1006 **106**
MAT A06 | SOFT S16

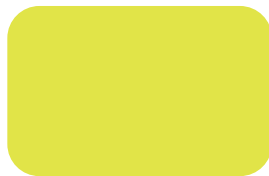

RAL 1016 **116**
MAT A16 | SOFT S06



RAL 1024 **124**
MAT A24 | SOFT R14



RAL 2000 **200**
MAT B00 | SOFT S20



RAL 2001 **201**
MAT B01 | SOFT S21



RAL 2012 **212**
MAT B12 | SOFT R22



RAL 3009 **309**
MAT C09 | SOFT S39



RAL 3018 **318**
MAT C18 | SOFT R38



RAL 2002 **202**
MAT B02 | SOFT S22



RAL 3000 **300**
MAT C00 | SOFT S30



RAL 3011 **311**
MAT C11 | SOFT R31



RAL 3020 **320**
MAT C20 | SOFT S36



RAL 2003 **203**
MAT B03 | SOFT S23



RAL 3001 **301**
MAT C01 | SOFT S31



RAL 3012 **312**
MAT C12 | SOFT R32



RAL 3022 **322**
MAT C22 | SOFT R02



RAL 2004 **204**
MAT B04 | SOFT S24



RAL 3002 **302**
MAT C02 | SOFT S32



RAL 3013 **313**
MAT C13 | SOFT R33



RAL 3027 **327**
MAT C27 | SOFT S27



RAL 2008 **208**
MAT B08 | SOFT S28



RAL 3003 **303**
MAT C03 | SOFT S33



RAL 3014 **314**
MAT C14 | SOFT R34



RAL 3028 **328**
MAT C28 | SOFT S38



RAL 2009 **209**
MAT B09 | SOFT S29



RAL 3004 **304**
MAT C04 | SOFT S34



RAL 3015 **315**
MAT C15 | SOFT R35



RAL 3031 **331**
MAT C31 | SOFT R01



RAL 2010 **210**
MAT B10 | SOFT R20



RAL 3005 **305**
MAT C05 | SOFT S35



RAL 3016 **316**
MAT C16 | SOFT R36



RAL 4001 **401**
MAT D01 | SOFT S41



RAL 2011 **211**
MAT B11 | SOFT R21

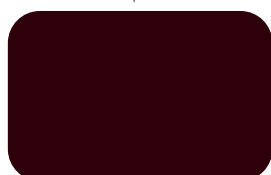

RAL 3007 **307**
MAT C07 | SOFT S37



RAL 3017 **317**
MAT C17 | SOFT R37



RAL 4002 **402**
MAT D02 | SOFT S42



RAL 4003 **403**
MAT **D03** | SOFT **S43**



RAL 5000 **500**
MAT **E00** | SOFT **S50**



RAL 5009 **509**
MAT **E09** | SOFT **S59**



RAL 5018 **518**
MAT **E18** | SOFT **R58**



RAL 4004 **404**
MAT **D04** | SOFT **S44**



RAL 5001 **501**
MAT **E01** | SOFT **S51**



RAL 5010 **510**
MAT **E10** | SOFT **R50**



RAL 5019 **519**
MAT **E19** | SOFT **R59**



RAL 4005 **405**
MAT **D05** | SOFT **S45**



RAL 5002 **502**
MAT **E02** | SOFT **R52**



RAL 5011 **511**
MAT **E11** | SOFT **R51**



RAL 5020 **520**
MAT **E20** | SOFT **S56**



RAL 4006 **406**
MAT **D06** | SOFT **S46**



RAL 5003 **503**
MAT **E03** | SOFT **S53**



RAL 5012 **512**
MAT **E12** | SOFT **S52**



RAL 5021 **521**
MAT **E21** | SOFT **R05**



RAL 4007 **407**
MAT **D07** | SOFT **S47**



RAL 5004 **504**
MAT **E04** | SOFT **S54**



RAL 5013 **513**
MAT **E13** | SOFT **R53**



RAL 5022 **522**
MAT **E22** | SOFT **R06**



RAL 4008 **408**
MAT **D08** | SOFT **S48**



RAL 5005 **505**
MAT **E05** | SOFT **S55**



RAL 5014 **514**
MAT **E14** | SOFT **R54**



RAL 5023 **523**
MAT **E23** | SOFT **R08**



RAL 4009 **409**
MAT **D09** | SOFT **S49**



RAL 5007 **507**
MAT **E07** | SOFT **S57**



RAL 5015 **515**
MAT **E15** | SOFT **R55**



RAL 5024 **524**
MAT **E24** | SOFT **R56**



RAL 4010 **410**
MAT **D10** | SOFT **S40**



RAL 5008 **508**
MAT **E08** | SOFT **S58**



RAL 5017 **517**
MAT **E17** | SOFT **R57**



RAL 6000 **600**
MAT **F00** | SOFT **S60**



RAL 6001 **601**
MAT F01 | SOFT R16



RAL 6009 **609**
MAT F09 | SOFT S69



RAL 6017 **617**
MAT F17 | SOFT R67



RAL 6026 **626**
MAT F26 | SOFT R26



RAL 6002 **602**
MAT F02 | SOFT S62



RAL 6010 **610**
MAT F10 | SOFT R60



RAL 6018 **618**
MAT F18 | SOFT R68



RAL 6027 **627**
MAT F27 | SOFT R27



RAL 6003 **603**
MAT F03 | SOFT S63



RAL 6011 **611**
MAT F11 | SOFT R61



RAL 6019 **619**
MAT F19 | SOFT R69



RAL 6028 **628**
MAT F28 | SOFT R28



RAL 6004 **604**
MAT F04 | SOFT S64



RAL 6012 **612**
MAT F12 | SOFT R62



RAL 6020 **620**
MAT F20 | SOFT R09



RAL 6029 **629**
MAT F29 | SOFT R29



RAL 6005 **605**
MAT F05 | SOFT S65



RAL 6013 **613**
MAT F13 | SOFT R63



RAL 6021 **621**
MAT F21 | SOFT S61



RAL 6032 **632**
MAT F32 | SOFT R23



RAL 6006 **606**
MAT 6M6 | SOFT S66



RAL 6014 **614**
MAT F14 | SOFT R64



RAL 6022 **622**
MAT F22 | SOFT S26



RAL 6033 **633**
MAT F33 | SOFT R15



RAL 6007 **607**
MAT F07 | SOFT S67



RAL 6015 **615**
MAT F15 | SOFT R65



RAL 6024 **624**
MAT F24 | SOFT R24



RAL 6034 **634**
MAT F34 | SOFT R39

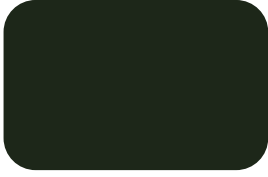

RAL 6008 **608**
MAT F08 | SOFT S68



RAL 6016 **616**
MAT F16 | SOFT R66



RAL 6025 **625**
MAT 6M5 | SOFT R25



RAL 6037 **637**
MAT F37 | SOFT O37



RAL 7000 **700**
MAT **G00** | SOFT **R70**



RAL 7009 **709**
MAT **G09** | SOFT **S79**



RAL 7022 **722**
MAT **7M1** | SOFT **S18**



RAL 7034 **734**
MAT **G34** | SOFT **R94**



RAL 7001 **701**
MAT **G01** | SOFT **S71**



RAL 7010 **710**
MAT **G10** | SOFT **R40**



RAL 7023 **723**
MAT **M23** | SOFT **S19**



RAL 7035 **735**
MAT **M35** | SOFT **R95**



RAL 7002 **702**
MAT **G02** | SOFT **R72**



RAL 7011 **711**
MAT **G11** | SOFT **R71**



RAL 7024 **724**
MAT **7M4** | SOFT **S74**



RAL 7036 **736**
MAT **G36** | SOFT **R45**



RAL 7003 **703**
MAT **G03** | SOFT **R73**



RAL 7012 **712**
MAT **G12** | SOFT **S72**



RAL 7026 **726**
MAT **G26** | SOFT **S25**



RAL 7037 **737**
MAT **G37** | SOFT **R47**



RAL 7004 **704**
MAT **G04** | SOFT **R74**



RAL 7013 **713**
MAT **G13** | SOFT **R43**



RAL 7030 **730**
MAT **G30** | SOFT **S70**



RAL 7038 **738**
MAT **G38** | SOFT **R78**



RAL 7005 **705**
MAT **G05** | SOFT **S75**



RAL 7015 **715**
MAT **G15** | SOFT **R75**



RAL 7031 **731**
MAT **G31** | SOFT **R49**



RAL 7039 **739**
MAT **G39** | SOFT **R79**



RAL 7006 **706**
MAT **G06** | SOFT **R76**



RAL 7016 **716**
MAT **7M6** | SOFT **S76**



RAL 7032 **732**
MAT **7M3** | SOFT **R92**



RAL 7040 **740**
MAT **7M0** | SOFT **R48**



RAL 7008 **708**
MAT **G08** | SOFT **S78**



RAL 7021 **721**
MAT **G21** | SOFT **R41**



RAL 7033 **733**
MAT **G33** | SOFT **R93**



RAL 7042 **742**
MAT **7M2** | SOFT **R42**



RAL 7043 **743**
MAT **G43** | SOFT **S73**



RAL 8003 **803**
MAT **H03** | SOFT **S83**



RAL 8016 **816**
MAT **H16** | SOFT **R86**



RAL 9001 **901**
MAT **9M1** | SOFT **S91**



RAL 7044 **744**
MAT **G44** | SOFT **754**



RAL 8004 **804**
MAT **H04** | SOFT **R84**



RAL 8017 **817**
MAT **H17** | SOFT **S87**



RAL 9002 **902**
MAT **J02** | SOFT **S92**



RAL 7045 **745**
MAT **7M5** | SOFT **R44**



RAL 8007 **807**
MAT **H07** | SOFT **R87**



RAL 8019 **819**
MAT **H19** | SOFT **R89**

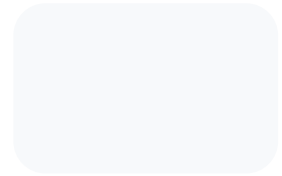

RAL 9003 **903**
MAT **9M3** | SOFT **S93**



RAL 7046 **746**
MAT **G46** | SOFT **R46**



RAL 8008 **808**
MAT **H08** | SOFT **S88**



RAL 8022 **822**
MAT **M82** | SOFT **R80**



RAL 9004 **904**
MAT **9M4** | SOFT **S94**



RAL 7047 **747**
MAT **M77** | SOFT **S77**



RAL 8011 **811**
MAT **8M1** | SOFT **R81**



RAL 8023 **823**
MAT **H23** | SOFT **R83**



RAL 9006 **906**
MAT **9M6** | SOFT **R96**



RAL 8000 **800**
MAT **H00** | SOFT **S80**



RAL 8012 **812**
MAT **H12** | SOFT **R82**



RAL 8024 **824**
MAT **H24** | SOFT **S84**



RAL 9007 **907**
MAT **9M7** | SOFT **S97**



RAL 8001 **801**
MAT **H01** | SOFT **S81**



RAL 8014 **814**
MAT **8M4** | SOFT **S89**



RAL 8025 **825**
MAT **H25** | SOFT **S85**

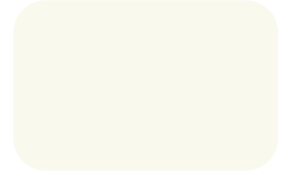

RAL 9010 **910**
MAT **9M0** | SOFT **S90**



RAL 8002 **802**
MAT **H02** | SOFT **S82**



RAL 8015 **815**
MAT **H15** | SOFT **R85**



RAL 8028 **828**
MAT **H28** | SOFT **R88**



RAL 9011 **911**
MAT **9R1** | SOFT **R91**

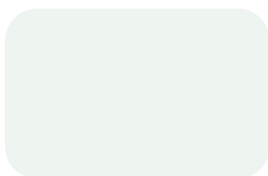

RAL 9016 **916**
MAT **J16** | SOFT **S96**



RAL 9017 **917**
MAT **M17** | SOFT **R97**



RAL 9018 **918**
MAT **J18** | SOFT **S98**

Barvy RAL 9005, 9016 a 3028 jsou ve VZORNÍKU SPECIÁLNÍCH BAREV označeny jako MATT (polomat) nebo SOFT (úplný mat) a lze je objednat bez příplatku.

Všechny ostatní uvedené barvy RAL můžete objednat pomocí kódů pod barevnými obdélníky v lesku (75% lesku) bez příplatku. RAL uvedené barvy můžete objednat také jako MAT (polomat 30% lesku), nebo SOFT (úplný mat 10% lesku) s příplatkem 25%, neboť se lakují vícekrát pro vytvoření vrstvy matného vzhledu.

MODELY SKLADEM

Radiátory, které potřebujete ihned můžete vybírat ze skladu TERMA pro ČR a SR.

Objednávky přijaté v režimu ceny EXW do 12h budou ještě ten den ze skladu TERMA pro ČR a SR expedovány a doručení záleží od rychlosti přepravce, standardně den odeslání + 24hodin.

Dostupnost na www stránkách je online a standardně vždy do Vyprodání zásob k dispozici na skladě TERMA pro ČR a SR.

Mimo dále prezentovaný již jen sklad TERMA pro ČR a SR, můžete ověřovat dostupnost skladových výrobků z CENTRÁLNÍHO SKLADU TERMA na en.termagroup.com.

Objednávky přijaté na CENTRÁLNÍ SKLAD TERMA do 12h budou ještě ten den expedovány a doručení záleží od rychlosti přepravce, standardně den odeslání + 3dny.

ZASÍLÁNÍ OBJEDNÁVEK

Terma velmi ráda vyrobí dle vaší z katalogu navolené konfigurace jednotkové objednávky radiátorů na zakázku. Tzn. pokud se koncový zákazník nechce omezovat skladovými rychle dodanými modely, nakonfigurujte s ním jakýkoliv radiátor v libovolných 650 barvách podle přání a my jej na zakázku vyrobíme.

Objednávejte prosím své objednávky takto:

1. Radiátory na zakázku / Atypické radiátory / Výrobky z CENTRÁLNÍHO SKLADU TERMA:

Objednávejte na: orders-heating@termagroup.pl

K objednávkám Atypických radiátorů vždy přikládejte i Cenovou nabídku od Regionálního Managera.

Do objednávek Výrobků z CENTRÁLNÍHO SKLADU TERMA vždy viditelně dopište „Z MAGAZYNU“, jinak automaticky budeme objednané zboží znovu vyrábět a budete čekat než bude vyrobeno.

2. Radiátory SKLADEM (sklad TERMA pro ČR a SR pro-

vozuje Dobráklíma, Bratislava):

Ověření aktuálních zásob skladových modelů:
www.dobraklima.sk/dizajnove-radiatory-skladom, případně obchodník +421 905 412 770

Objednávejte na: info@dobraklima.sk

Do objednávky dopište „ZE SKLADU“

Upozorňujeme: Pokud se spolu s Vaší objednávkou sejde příliš mnoho objednávek, může dojít k vyčerpání skladových zásob vybraného rozměru a budete upozorněni na datum, kdy budou z produkce tyto radiátory znovu na sklad dodány. Zákazník si může samozřejmě zvolit jiný rozměr, barvu, model nebo si nechat vyrobit radiátor na zakázku jako v možnosti 1.



SADA OBSAHUJE:

Radiátor je prodáván v ceně spolu se třemi redukcemi, jednou euro zátkou, odvzdušňovacím ventilem, háky do zdi a stěhovacími pásy.

DOPORUČUJEME PRO PŘIPOJENÍ LP:



Sada rohová regulační "Mini-malist"

TGZR017: 228 EUR

Stránka: 344

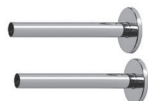

Sada krycí dvojitá, Chrom

TGPCR004: 33 EUR

Stránka: 346



SKUPINY BAREV A VYKONČENÍ:

Skupina 1 – Raw Metal, Metal Alive, 190 barev RAL, White Soft, Frost, Metallic Brown, Autumn, Evening Garden, Shadow Gold, Graff i Flat Black

Skupina 2 – Full Burnish, Shaded Burnish, Antique Brass, Antique Copper, Bottle Green, Red Wine, Midnight

Skupina 3 – Ornament Gold, Ornament Silver, Ornament Copper, Galvanic Copper, Polished Metal

RADIÁTOR VODNÍ:

Připojení:



V tabulkách jsou pouze ukázkové sady do 17 článků. Lze objednat delší radiátory.

Radiátor nad 13 článků je dodáván ve dvou nebo více sestavách.

↔ [mm]	75/65/20°C [W]	55/45/20°C [W]	Počet článků	Skupina 1 Cena bez DPH [EUR]	Skupina 2 Cena bez DPH [EUR]	Skupina 3 Cena bez DPH [EUR]	Kód produktu ... Kód konfigurace s. 385
580 ⇅ [mm] – Verze nástěnná							
80	73	39	1	114	132	165	WGBRB058008...
278	218	116	3	342	396	495	WGBRB058027...
360	291	154	4	456	528	660	WGBRB058036...
442	364	193	5	570	660	825	WGBRB058044...
524	436	232	6	684	792	990	WGBRB058052...
606	509	270	7	798	924	1155	WGBRB058060...
688	582	309	8	912	1056	1320	WGBRB058068...
770	654	347	9	1026	1188	1485	WGBRB058077...
852	727	386	10	1140	1320	1650	WGBRB058085...
934	800	425	11	1254	1452	1815	WGBRB058093...
1016	872	463	12	1368	1584	1980	WGBRB058101...
1098	945	502	13	1482	1716	2145	WGBRB058109...
1180	1018	540	14	1596	1848	2310	WGBRB058118...
1262	1091	579	15	1710	1980	2475	WGBRB058126...
1344	1163	618	16	1824	2112	2640	WGBRB058134...
1426	1236	656	17	1938	2244	2805	WGBRB058142...

↔ [mm]	75/65/20°C [W]	55/45/20°C [W]	Počet článků	Skupina 1 Cena bez DPH [EUR]	Skupina 2 Cena bez DPH [EUR]	Skupina 3 Cena bez DPH [EUR]	Kód produktu ... Kód konfigurace s.385
640 ⇄ [mm] – Verze s nožkami							
80	73	39	1	114	132	165	WGBRF064008...
278	218	116	3	342	396	495	WGBRF064027...
360	291	154	4	456	528	660	WGBRF064036...
442	364	193	5	570	660	825	WGBRF064044...
524	436	232	6	684	792	990	WGBRF064052...
606	509	270	7	798	924	1155	WGBRF064060...
688	582	309	8	912	1056	1320	WGBRF064068...
770	654	347	9	1026	1188	1485	WGBRF064077...
852	727	386	10	1140	1320	1650	WGBRF064085...
934	800	425	11	1254	1452	1815	WGBRF064093...
1016	872	463	12	1368	1584	1980	WGBRF064101...
1098	945	502	13	1482	1716	2145	WGBRF064109...
1180	1018	540	14	1596	1848	2310	WGBRF064118...
1262	1091	579	15	1710	1980	2475	WGBRF064126...
1344	1163	618	16	1824	2112	2640	WGBRF064134...
1426	1236	656	17	1938	2244	2805	WGBRF064142...

Bergamo



Hliníkový radiátor

DOPORUČUJEME PRO PŘIPOJENÍ LP:



Sada regulační rohová

Chrom

WRZRCK1-CR: 99 EUR

Stránka: 326



Sada krycí dvojitá, Chrom

TGPCR001: 27 EUR

Stránka: 373

RADIÁTOR VODNÍ:

Připojení:



MONTÁŽNÍ SADA:

- Růžice redukční levá 1" x 1/2" — 2 ks
- Růžice redukční pravá 1" x 1/2" — 2 ks
- těsnění — 4 ks
- Zátka — 1 ks
- Odvzdušňovací ventil — 1/2" — 1 ks
- Hmoždinky — 3 ks
- Montážní háky — 3 ks

K ceně každého radiátoru Bergamo je potřeba dopočítat 14 EUR bez DPH za Montážní sadu v bílé RAL 9016 nebo 16 EUR bez DPH v ostatních Bergamo barvách.

Počet článků	A ↕ [mm]	B ↔ [mm]	75/65/20°C [W]	55/45/20°C [W]	Standardní barvy* Cena bez DPH [EUR]	Barvy pro radiátor Bergamo Cena bez DPH [EUR]	Kód produktu ... Kód konfigurace s. 385
2	590	160	225	116	–	142	WGBER059016...
3	590	240	338	174	–	171	WGBER059024...
4	590	320	450	232	–	199	WGBER059032...
5	590	400	563	290	–	229	WGBER059040...
6	590	480	676	347	–	257	WGBER059048...
7	590	560	788	405	–	286	WGBER059056...
8	590	640	901	463	–	315	WGBER059064...
9	590	720	1013	521	–	347	WGBER059072...
10	590	800	1126	579	283	377	WGBER059080...
11	590	880	1239	637	–	405	WGBER059088...
12	590	960	1351	695	–	432	WGBER059096...
13	590	1040	1464	753	–	460	WGBER059104...
14	590	1120	1576	811	–	488	WGBER059112...
15	590	1200	1689	869	–	516	WGBER059120...
16	590	1280	1802	926	–	544	WGBER059128...
17	590	1360	1914	984	–	572	WGBER059136...
18	590	1440	2027	1042	–	601	WGBER059144...
19	590	1520	2139	1100	–	629	WGBER059152...
20	590	1600	2252	1158	–	657	WGBER059160...

*Standardní barvy: Bílá - RAL 9016 (916)

Bergamo E



Hliníkový radiátor

RADIÁTOR ELEKTRICKÝ (K VYTÁPĚNÍ MÍSTNOSTI, NAPLNĚNÝ OLEJEM S TOPNÝM ELEMENTEM TS1, DOKOUPIT REGULÁTOR KTX4 BLUE NEBO S TOPNÝM ELEMENTEM SS1, DOKOUPIT REGULÁTOR SMART WI-FI VEO)

Připojení:

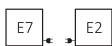

K ceně každého radiátoru Bergamo je potřeba dopočítat 14 EUR bez DPH za Montážní sadu v bílé RAL 9016 nebo 16 EUR bez DPH v ostatních Bergamo barvách.

Počet článků	A ↓ [mm]	B ↔ [mm]	 [W]	Standardní barvy* Cena bez DPH [EUR]	Barvy pro radiátor Bergamo Cena bez DPH [EUR]	Kód produktu ... Kód konfigurace s.388
10	590	800	1000	326	420	WLBEO59080...

*Standardní barvy: Bílá - RAL 9016 (916)



SADA OBSAHUJE:

Radiátor je prodáván v ceně spolu se třemi redukcemi, jednou euro zátkou, odvzdušňovacím ventilem, háky do zdi a stěhovacími pásy.

DOPORUČUJEME PRO PŘIPOJENÍ LP:



Sada rohová regulační „Classic Art”

– antracit

TGERANT01: 199 EUR

Stránka: 344



Sada krycí dvojitá „Artistic”

– Antracit

TGPAN001: 64 EUR

Stránka: 346

RADIÁTOR VODNÍ:

Připojení:



V tabulkách jsou pouze ukázkové sady do 17 článků. Lze objednat delší radiátory. Radiátor nad 13 článků je dodáván ve dvou nebo více sestavách.



SKUPINY BAREV A VYKONČENÍ:

Skupina 1 – Raw Metal, Metal Alive, 190 barev RAL, White Soft, Frost, Metallic Brown, Autumn, Evening Garden, Shadow Gold, Graff i Flat Black

Skupina 2 – Full Burnish, Shaded Burnish, Antique Brass, Antique Copper, Bottle Green, Red Wine, Midnight

Skupina 3 – Ornament Gold, Ornament Silver, Ornament Copper, Galvanic Copper, Polished Metal

↔ [mm]	75/65/20°C [W]	55/45/20°C [W]	Počet článků	Skupina 1 Cena bez DPH [EUR]	Skupina 2 Cena bez DPH [EUR]	Skupina 3 Cena bez DPH [EUR]	Kód produktu ... Kód konfigurace s. 385
460 ⇄ [mm] – Verze nástěnná							
80	87	46	1	149	175	217	WGKAB046008...
278	259	137	3	447	525	651	WGKAB046027...
360	346	183	4	596	700	868	WGKAB046036...
442	432	228	5	745	875	1085	WGKAB046044...
524	518	274	6	894	1050	1302	WGKAB046052...
606	605	320	7	1043	1225	1519	WGKAB046060...
688	691	365	8	1192	1400	1736	WGKAB046068...
770	777	411	9	1341	1575	1953	WGKAB04607...
852	863	457	10	1490	1750	2170	WGKAB046085...
934	950	502	11	1639	1925	2387	WGKAB046093...
1016	1036	548	12	1788	2100	2604	WGKAB046101...
1098	1122	594	13	1937	2275	2821	WGKAB046109...
1180	1209	640	14	2086	2450	3038	WGKAB046118...
1262	1295	685	15	2235	2625	3255	WGKAB046126...
1344	1381	731	16	2384	2800	3472	WGKAB046134...
1426	1468	777	17	2533	2975	3689	WGKAB046142...

↔ [mm]	75/65/20°C [W]	55/45/20°C [W]	Počet článků	Skupina 1 Cena bez DPH [EUR]	Skupina 2 Cena bez DPH [EUR]	Skupina 3 Cena bez DPH [EUR]	Kód produktu ... Kód konfigurace s. 385
660 ⇄ [mm] – Verze nástěnná							
80	120	65	1	196	228	288	WGKAB066008...
278	361	195	3	588	684	864	WGKAB066027...
360	481	260	4	784	912	1152	WGKAB066036...
442	602	325	5	980	1140	1440	WGKAB066044...
524	722	391	6	1176	1368	1728	WGKAB066052...
606	842	456	7	1372	1596	2016	WGKAB066060...
688	962	521	8	1568	1824	2304	WGKAB066068...
770	1083	586	9	1764	2052	2592	WGKAB066077...
852	1203	651	10	1960	2280	2880	WGKAB066085...
934	1323	716	11	2156	2508	3168	WGKAB066093...
1016	1444	781	12	2352	2736	3456	WGKAB066101...
1098	1564	846	13	2548	2964	3744	WGKAB066109...
1180	1684	911	14	2744	3192	4032	WGKAB066118...
1262	1805	976	15	2940	3420	4320	WGKAB066126...
1344	1925	1041	16	3136	3648	4608	WGKAB066134...
1426	2045	1107	17	3332	3876	4896	WGKAB066142...

860 ⇄ [mm] – Verze nástěnná

80	120	65	1	254	296	393	WGKAB086008...
278	361	195	3	762	888	1179	WGKAB086027...
360	481	260	4	1016	1184	1572	WGKAB086036...
442	602	325	5	1270	1480	1965	WGKAB086044...
524	722	391	6	1524	1776	2358	WGKAB086052...
606	842	456	7	1778	2072	2751	WGKAB086060...
688	962	521	8	2032	2368	3144	WGKAB086068...
770	1083	586	9	2286	2664	3537	WGKAB086077...
852	1203	651	10	2540	2960	3930	WGKAB086085...
934	1323	716	11	2794	3256	4323	WGKAB086093...
1016	1444	781	12	3048	3552	4716	WGKAB086101...
1098	1564	846	13	3302	3848	5109	WGKAB086109...
1180	1684	911	14	3556	4144	5502	WGKAB086118...
1262	1805	976	15	3810	4440	5895	WGKAB086126...
1344	1925	1041	16	4064	4736	6288	WGKAB086134...
1426	2045	1107	17	4318	5032	6681	WGKAB086142...

↔ [mm]	75/65/20°C [W]	55/45/20°C [W]	Počet článků	Skupina1 Cena bez DPH [EUR]	Skupina2 Cena bez DPH [EUR]	Skupina3 Cena bez DPH [EUR]	Kód produktu ... Kód konfigurace s. 385
520 ⇅ [mm] – Verze s nožkami							
80	120	65	1	149	175	217	WGKAF052008...
278	361	195	3	447	525	651	WGKAF052027...
360	481	260	4	596	700	868	WGKAF052036...
442	602	325	5	745	875	1085	WGKAF052044...
524	722	391	6	894	1050	1302	WGKAF052052...
606	842	456	7	1043	1225	1519	WGKAF052060...
688	962	521	8	1192	1400	1736	WGKAF052068...
770	1083	586	9	1341	1575	1953	WGKAF052077...
852	1203	651	10	1490	1750	2170	WGKAF052085...
934	1323	716	11	1639	1925	2387	WGKAF052093...
1016	1444	781	12	1788	2100	2604	WGKAF052101...
1098	1564	846	13	1937	2275	2821	WGKAF052109...
1180	1684	911	14	2086	2450	3038	WGKAF052118...
1262	1805	976	15	2235	2625	3255	WGKAF052126...
1344	1925	1041	16	2384	2800	3472	WGKAF052134...
1426	2045	1107	17	2533	2975	3689	WGKAF052142...

720 ⇅ [mm] – Verze s nožkami

80	120	65	1	196	228	288	WGKAF072008...
278	361	195	3	588	684	864	WGKAF072027...
360	481	260	4	784	912	1152	WGKAF072036...
442	602	325	5	980	1140	1440	WGKAF072044...
524	722	391	6	1176	1368	1728	WGKAF072052...
606	842	456	7	1372	1596	2016	WGKAF072060...
688	962	521	8	1568	1824	2304	WGKAF072068...
770	1083	586	9	1764	2052	2592	WGKAF072077...
852	1203	651	10	1960	2280	2880	WGKAF072085...
934	1323	716	11	2156	2508	3168	WGKAF072093...
1016	1444	781	12	2352	2736	3456	WGKAF072101...
1098	1564	846	13	2548	2964	3744	WGKAF072109...
1180	1684	911	14	2744	3192	4032	WGKAF072118...
1262	1805	976	15	2940	3420	4320	WGKAF072126...
1344	1925	1041	16	3136	3648	4608	WGKAF072134...
1426	2045	1107	17	3332	3876	4896	WGKAF072142...

↔ [mm]	75/65/20°C [W]	55/45/20°C [W]	Počet článků	Skupina1 Cena bez DPH [EUR]	Skupina2 Cena bez DPH [EUR]	Skupina3 Cena bez DPH [EUR]	Kód produktu ... Kód konfigurace s.385
920 ⇄[mm] – Verze s nožkami							
80	120	65	1	254	296	393	WGKAF092008...
278	361	195	3	762	888	1179	WGKAF092027...
360	481	260	4	1016	1184	1572	WGKAF092036...
442	602	325	5	1270	1480	1965	WGKAF092044...
524	722	391	6	1524	1776	2358	WGKAF092052...
606	842	456	7	1778	2072	2751	WGKAF092060...
688	962	521	8	2032	2368	3144	WGKAF092068...
770	1083	586	9	2286	2664	3537	WGKAF092077...
852	1203	651	10	2540	2960	3930	WGKAF092085...
934	1323	716	11	2794	3256	4323	WGKAF092093...
1016	1444	781	12	3048	3552	4716	WGKAF092101...
1098	1564	846	13	3302	3848	5109	WGKAF092109...
1180	1684	911	14	3556	4144	5502	WGKAF092118...
1262	1805	976	15	3810	4440	5895	WGKAF092126...
1344	1925	1041	16	4064	4736	6288	WGKAF092134...
1426	2045	1107	17	4318	5032	6681	WGKAF092142...



SADA OBSAHUJE:

Radiátor je prodáván v ceně spolu se třemi redukcemi, jednou euro zátkou, odvzdušňovacím ventilem, háky do zdi a stěhovacími pásy.

DOPORUČUJEME PRO PŘIPOJENÍ LP:



Sada regulační termostatická „Artistic“ – Antracit

TGETAN002: 190 EUR

Stránka: 345



Sada krycí dvojitá „Artistic“ – Antracit

TGPAN001: 64 EUR

Stránka: 346

RADIÁTOR VODNÍ:

Připojení:



V tabulkách jsou pouze ukázkové sady do 17 článků. Lze objednat delší radiátory. Radiátor nad 13 článků je dodáván ve dvou nebo více sestavách.



SKUPINY BAREV A VYKONČENÍ:

Skupina 1 – Raw Metal, Metal Alive, 190 barev RAL, White Soft, Frost, Metallic Brown, Autumn, Evening Garden, Shadow Gold, Graff i Flat Black

Skupina 2 – Full Burnish, Shaded Burnish, Antique Brass, Antique Copper, Bottle Green, Red Wine, Midnight

Skupina 3 – Ornament Gold, Ornament Silver, Ornament Copper, Galvanic Copper, Polished Metal

↔ [mm]	75/65/20°C [W]	55/45/20°C [W]	Počet článků	Skupina 1 Cena bez DPH [EUR]	Skupina 2 Cena bez DPH [EUR]	Skupina 3 Cena bez DPH [EUR]	Kód produktu ... Kód konfigurace s. 385
410 ⇄ [mm] – Verze nástěnná							
80	86	44	1	147	162	206	WGOXB041008...
278	257	133	3	441	486	618	WGOXB041027...
360	343	177	4	588	648	824	WGOXB041036...
442	429	222	5	735	810	1030	WGOXB041044...
524	515	266	6	882	972	1236	WGOXB041052...
606	601	310	7	1029	1134	1442	WGOXB041060...
688	686	355	8	1176	1296	1648	WGOXB041068...
770	772	399	9	1323	1458	1854	WGOXB041077...
852	858	443	10	1470	1620	2060	WGOXB041085...
934	944	488	11	1617	1782	2266	WGOXB041093...
1016	1030	532	12	1764	1944	2472	WGOXB041101...
1098	1115	577	13	1911	2106	2678	WGOXB041109...
1180	1201	621	14	2058	2268	2884	WGOXB041118...
1262	1287	665	15	2205	2430	3090	WGOXB041126...
1344	1373	710	16	2352	2592	3296	WGOXB041134...
1426	1459	754	17	2499	2754	3502	WGOXB041142...

↔ [mm]	75/65/20°C [W]	55/45/20°C [W]	Počet článků	Skupina 1 Cena bez DPH [EUR]	Skupina 2 Cena bez DPH [EUR]	Skupina 3 Cena bez DPH [EUR]	Kód produktu ... Kód konfigurace s. 385
470 ⇄ [mm] – Verze s nožkami							
80	86	44	1	147	162	206	WGOXF047008...
278	257	133	3	441	486	618	WGOXF047027...
360	343	177	4	588	648	824	WGOXF047036...
442	429	222	5	735	810	1030	WGOXF047044...
524	515	266	6	882	972	1236	WGOXF047052...
606	601	310	7	1029	1134	1442	WGOXF047060...
688	686	355	8	1176	1296	1648	WGOXF047068...
770	772	399	9	1323	1458	1854	WGOXF047077...
852	858	443	10	1470	1620	2060	WGOXF047085...
934	944	488	11	1617	1782	2266	WGOXF047093...
1016	1030	532	12	1764	1944	2472	WGOXF047101...
1098	1115	577	13	1911	2106	2678	WGOXF047109...
1180	1201	621	14	2058	2268	2884	WGOXF047118...
1262	1287	665	15	2205	2430	3090	WGOXF047126...
1344	1373	710	16	2352	2592	3296	WGOXF047134...
1426	1459	754	17	2499	2754	3502	WGOXF047142...

660 ⇄ [mm] – Verze nástěnná

80	143	76	1	195	218	278	WGOXB066008...
278	429	227	3	585	654	834	WGOXB066027...
360	572	303	4	780	872	1112	WGOXB066036...
442	715	379	5	975	1090	1390	WGOXB066044...
524	858	454	6	1170	1308	1668	WGOXB066052...
606	1001	530	7	1365	1526	1946	WGOXB066060...
688	1144	606	8	1560	1744	2224	WGOXB066068...
770	1287	682	9	1755	1962	2502	WGOXB066077...
852	1430	757	10	1950	2180	2780	WGOXB066085...
934	1573	833	11	2145	2398	3058	WGOXB066093...
1016	1716	909	12	2340	2616	3336	WGOXB066101...
1098	1859	985	13	2535	2834	3614	WGOXB066109...
1180	2002	1060	14	2730	3052	3892	WGOXB066118...
1262	2145	1136	15	2925	3270	4170	WGOXB066126...
1344	2288	1212	16	3120	3488	4448	WGOXB066134...
1426	2431	1288	17	3315	3706	4726	WGOXB066142...

↔ [mm]	75/65/20°C [W]	55/45/20°C [W]	Počet článků	Skupina 1 Cena bez DPH [EUR]	Skupina 2 Cena bez DPH [EUR]	Skupina 3 Cena bez DPH [EUR]	Kód produktu ... Kód konfigurace s.385
710 ⇄ [mm] – Verze s nožkami							
80	143	76	1	195	218	278	WGOXF071008...
278	429	227	3	585	654	834	WGOXF071027...
360	572	303	4	780	872	1112	WGOXF071036...
442	715	379	5	975	1090	1390	WGOXF071044...
524	858	454	6	1170	1308	1668	WGOXF071052...
606	1001	530	7	1365	1526	1946	WGOXF071060...
688	1144	606	8	1560	1744	2224	WGOXF071068...
770	1287	682	9	1755	1962	2502	WGOXF071077...
852	1430	757	10	1950	2180	2780	WGOXF071085...
934	1573	833	11	2145	2398	3058	WGOXF071093...
1016	1716	909	12	2340	2616	3336	WGOXF071101...
1098	1859	985	13	2535	2834	3614	WGOXF071109...
1180	2002	1060	14	2730	3052	3892	WGOXF071118...
1262	2145	1136	15	2925	3270	4170	WGOXF071126...
1344	2288	1212	16	3120	3488	4448	WGOXF071134...
1426	2431	1288	17	3315	3706	4726	WGOXF071142...

Plain



SADA OBSAHUJE:

Radiátor je prodáván v ceně spolu se třemi redukcemi, jednou euro zátkou, odvzdušňovacím ventilem, háky do zdi a stěhovacími pásy.

DOPORUČUJEME PRO PŘIPOJENÍ LP:



Sada rohová regulační

"Minimalist", Chrom

TGZR017: 228 EUR

Stránka: 344

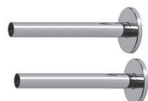

Sada krycí dvojitá, Chrom

TGPCR004: 33 EUR

Stránka: 346



SKUPINY BAREV A VYKONČENÍ:

Skupina 1 – Raw Metal, Metal Alive, 190 barev RAL, White Soft, Frost, Metallic Brown, Autumn, Evening Garden, Shadow Gold, Graff i Flat Black

Skupina 2 – Full Burnish, Shaded Burnish, Antique Brass, Antique Copper, Bottle Green, Red Wine, Midnight

Skupina 3 – Ornament Gold, Ornament Silver, Ornament Copper, Galvanic Copper, Polished Metal

RADIÁTOR VODNÍ:

Připojení:



V tabulkách jsou pouze ukázkové sady do 17 článků. Lze objednat delší radiátory.

Radiátor nad 13 článků je dodáván ve dvou nebo více sestavách.

↔ [mm]	75/65/20°C [W]	55/45/20°C [W]	Počet článků	Skupina 1 Cena bez DPH [EUR]	Skupina 2 Cena bez DPH [EUR]	Skupina 3 Cena bez DPH [EUR]	Kód produktu ... Kód konfigurace s. 385
-----------	-------------------	-------------------	-----------------	---------------------------------	---------------------------------	---------------------------------	--------------------------------------------

460 ⇄ [mm] – Verze nástěnná

80	86	46	1	138	159	198	WGPLB046008...
278	259	137	3	414	477	594	WGPLB046027...
360	345	183	4	552	636	792	WGPLB046036...
442	432	228	5	690	795	990	WGPLB046044...
524	518	274	6	828	954	1188	WGPLB046052...
606	604	320	7	966	1113	1386	WGPLB046060...
688	690	365	8	1104	1272	1584	WGPLB046068...
770	777	411	9	1242	1431	1782	WGPLB046077...
852	863	457	10	1380	1590	1980	WGPLB046085...
934	949	503	11	1518	1749	2178	WGPLB046093...
1016	1036	548	12	1656	1908	2376	WGPLB046101...
1098	1122	594	13	1794	2067	2574	WGPLB046109...
1180	1208	640	14	1932	2226	2772	WGPLB046118...
1262	1295	685	15	2070	2385	2970	WGPLB046126...
1344	1381	731	16	2208	2544	3168	WGPLB046134...
1426	1467	777	17	2346	2703	3366	WGPLB046142...

↔ [mm]	75/65/20°C [W]	55/45/20°C [W]	Počet článků	Skupina 1 Cena bez DPH [EUR]	Skupina 2 Cena bez DPH [EUR]	Skupina 3 Cena bez DPH [EUR]	Kód produktu ... Kód konfigurace s.385
520 ⇅ [mm] – Verze s nožkami							
80	86	46	1	138	159	198	WGPLF052008...
278	259	137	3	414	477	594	WGPLF052027...
360	345	183	4	552	636	792	WGPLF052036...
442	432	228	5	690	795	990	WGPLF052044...
524	518	274	6	828	954	1188	WGPLF052052...
606	604	320	7	966	1113	1386	WGPLF052060...
688	690	365	8	1104	1272	1584	WGPLF052068...
770	777	411	9	1242	1431	1782	WGPLF052077...
852	863	457	10	1380	1590	1980	WGPLF052085...
934	949	503	11	1518	1749	2178	WGPLF052093...
1016	1036	548	12	1656	1908	2376	WGPLF052101...
1098	1122	594	13	1794	2067	2574	WGPLF052109...
1180	1208	640	14	1932	2226	2772	WGPLF052118...
1262	1295	685	15	2070	2385	2970	WGPLF052126...
1344	1381	731	16	2208	2544	3168	WGPLF052134...
1426	1467	777	17	2346	2703	3366	WGPLF052142...
560 ⇅ [mm] – Verze nástěnná							
80	103	54	1	147	170	226	WGPLB056008...
278	308	163	3	441	510	678	WGPLB056027...
360	410	217	4	588	680	904	WGPLB056036...
442	513	271	5	735	850	1130	WGPLB056044...
524	615	325	6	882	1020	1356	WGPLB056052...
606	718	379	7	1029	1190	1582	WGPLB056060...
688	820	434	8	1176	1360	1808	WGPLB056068...
770	923	488	9	1323	1530	2034	WGPLB056077...
852	1025	542	10	1470	1700	2260	WGPLB056085...
934	1128	596	11	1617	1870	2486	WGPLB056093...
1016	1230	650	12	1764	2040	2712	WGPLB056101...
1098	1333	705	13	1911	2210	2938	WGPLB056109...
1180	1435	759	14	2058	2380	3164	WGPLB056118...
1262	1538	813	15	2205	2550	3390	WGPLB056126...
1344	1640	867	16	2352	2720	3616	WGPLB056134...
1426	1743	921	17	2499	2890	3842	WGPLB056142...
620 ⇅ [mm] – Verze s nožkami							
80	103	54	1	147	170	226	WGPLF062008...
278	308	163	3	441	510	678	WGPLF062027...
360	410	217	4	588	680	904	WGPLF062036...
442	513	271	5	735	850	1130	WGPLF062044...
524	615	325	6	882	1020	1356	WGPLF062052...
606	718	379	7	1029	1190	1582	WGPLF062060...
688	820	434	8	1176	1360	1808	WGPLF062068...
770	923	488	9	1323	1530	2034	WGPLF062077...
852	1025	542	10	1470	1700	2260	WGPLF062085...
934	1128	596	11	1617	1870	2486	WGPLF062093...

↔ [mm]	75/65/20°C [W]	55/45/20°C [W]	Počet článků	Skupina 1 Cena bez DPH [EUR]	Skupina 2 Cena bez DPH [EUR]	Skupina 3 Cena bez DPH [EUR]	Kód produktu ... Kód konfigurace s. 385
1016	1230	650	12	1764	2040	2712	WGPLF062101...
1098	1333	705	13	1911	2210	2938	WGPLF062109...
1180	1435	759	14	2058	2380	3164	WGPLF062118...
1262	1538	813	15	2205	2550	3390	WGPLF062126...
1344	1640	867	16	2352	2720	3616	WGPLF062134...
1426	1743	921	17	2499	2890	3842	WGPLF062142...

660 ⇅ [mm] – Verze nástěnná

80	124	66	1	159	182	237	WGPLB066008...
278	372	198	3	477	546	711	WGPLB066027...
360	496	265	4	636	728	948	WGPLB066036...
442	620	331	5	795	910	1185	WGPLB066044...
524	744	397	6	954	1092	1422	WGPLB066052...
606	868	463	7	1113	1274	1659	WGPLB066060...
688	992	529	8	1272	1456	1896	WGPLB066068...
770	1116	595	9	1431	1638	2133	WGPLB066077...
852	1240	661	10	1590	1820	2370	WGPLB066085...
934	1364	728	11	1749	2002	2607	WGPLB066093...
1016	1488	794	12	1908	2184	2844	WGPLB066101...
1098	1612	860	13	2067	2366	3081	WGPLB066109...
1180	1736	926	14	2226	2548	3318	WGPLB066118...
1262	1860	992	15	2385	2730	3555	WGPLB066126...
1344	1984	1058	16	2544	2912	3792	WGPLB066134...
1426	2108	1124	17	2703	3094	4029	WGPLB066142...

720 ⇅ [mm] – Verze s nožkami

80	124	66	1	159	182	237	WGPLF072008...
278	372	198	3	477	546	711	WGPLF072027...
360	496	265	4	636	728	948	WGPLF072036...
442	620	331	5	795	910	1185	WGPLF072044...
524	744	397	6	954	1092	1422	WGPLF072052...
606	868	463	7	1113	1274	1659	WGPLF072060...
688	992	529	8	1272	1456	1896	WGPLF072068...
770	1116	595	9	1431	1638	2133	WGPLF072077...
852	1240	661	10	1590	1820	2370	WGPLF072085...
934	1364	728	11	1749	2002	2607	WGPLF072093...
1016	1488	794	12	1908	2184	2844	WGPLF072101...
1098	1612	860	13	2067	2366	3081	WGPLF072109...
1180	1736	926	14	2226	2548	3318	WGPLF072118...
1262	1860	992	15	2385	2730	3555	WGPLF072126...
1344	1984	1058	16	2544	2912	3792	WGPLF072134...
1426	2108	1124	17	2703	3094	4029	WGPLF072142...

↔ [mm]	75/65/20°C [W]	55/45/20°C [W]	Počet článků	Skupina 1 Cena bez DPH [EUR]	Skupina 2 Cena bez DPH [EUR]	Skupina 3 Cena bez DPH [EUR]	Kód produktu ... Kód konfigurace s.385
860 ⇄ [mm] – Verze nástěnná							
80	161	86	1	177	207	269	WGPLB086008...
278	483	258	3	531	621	807	WGPLB086027...
360	644	344	4	708	828	1076	WGPLB086036...
442	805	429	5	885	1035	1345	WGPLB086044...
524	966	515	6	1062	1242	1614	WGPLB086052...
606	1127	601	7	1239	1449	1883	WGPLB086060...
688	1288	687	8	1416	1656	2152	WGPLB086068...
770	1449	773	9	1593	1863	2421	WGPLB086077...
852	1610	859	10	1770	2070	2690	WGPLB086085...
934	1771	945	11	1947	2277	2959	WGPLB086093...
1016	1932	1031	12	2124	2484	3228	WGPLB086101...
1098	2093	1116	13	2301	2691	3497	WGPLB086109...
1180	2254	1202	14	2478	2898	3766	WGPLB086118...
1262	2415	1288	15	2655	3105	4035	WGPLB086126...
1344	2576	1374	16	2832	3312	4304	WGPLB086134...
1426	2737	1460	17	3009	3519	4573	WGPLB086142...

920 ⇄ [mm] – Verze s nožkami

80	161	86	1	177	207	269	WGPLF092008...
278	483	258	3	531	621	807	WGPLF092027...
360	644	344	4	708	828	1076	WGPLF092036...
442	805	429	5	885	1035	1345	WGPLF092044...
524	966	515	6	1062	1242	1614	WGPLF092052...
606	1127	601	7	1239	1449	1883	WGPLF092060...
688	1288	687	8	1416	1656	2152	WGPLF092068...
770	1449	773	9	1593	1863	2421	WGPLF092077...
852	1610	859	10	1770	2070	2690	WGPLF092085...
934	1771	945	11	1947	2277	2959	WGPLF092093...
1016	1932	1031	12	2124	2484	3228	WGPLF092101...
1098	2093	1116	13	2301	2691	3497	WGPLF092109...
1180	2254	1202	14	2478	2898	3766	WGPLF092118...
1262	2415	1288	15	2655	3105	4035	WGPLF092126...
1344	2576	1374	16	2832	3312	4304	WGPLF092134...
1426	2737	1460	17	3009	3519	4573	WGPLF092142...

Plain 3K



SADA OBSAHUJE:

Radiátor je prodáván v ceně spolu se třemi redukcemi, jednou euro zátkou, odvzdušňovacím ventilem, háky do zdi a stěhovacími pásy.

DOPORUČUJEME PRO PŘIPOJENÍ LP:



Sada rohová regulační
"Minimalist", Chrom
TGZRCR017: 228 EUR
Stránka: 344



Sada krycí dvojitá, Chrom
TGPCR004: 33 EUR
Stránka: 346



RADIÁTOR VODNÍ:

Připojení:



SKUPINY BAREV A VYKONČENÍ:

Skupina 1 – Raw Metal, Metal Alive, 190 barev RAL, White Soft, Frost, Metallic Brown, Autumn, Evening Garden, Shadow Gold, Graff i Flat Black

Skupina 2 – Full Burnish, Shaded Burnish, Antique Brass, Antique Copper, Bottle Green, Red Wine, Midnight

Skupina 3 – Ornament Gold, Ornament Silver, Ornament Copper, Galvanic Copper, Polished Metal

V tabulkách jsou pouze ukázkové sady do 17 článků. Lze objednat delší radiátory.
Radiátor nad 13 článků je dodáván ve dvou nebo více sestavách.

↔ [mm]	75/65/20°C [W]	55/45/20°C [W]	Počet článků	Skupina 1 Cena bez DPH [EUR]	Skupina 2 Cena bez DPH [EUR]	Skupina 3 Cena bez DPH [EUR]	Kód produktu ... Kód konfigurace s. 385
-----------	-------------------	-------------------	-----------------	---------------------------------	---------------------------------	---------------------------------	------------------------------------------------------------

460 ⇄ [mm] – Verze nástěnná **NOVINKA**

80	97	50	1	159	192	230	WGP3B046008...
278	290	151	3	477	576	690	WGP3B046027...
360	386	201	4	636	768	920	WGP3B046036...
442	483	251	5	795	960	1150	WGP3B046044...
524	580	301	6	954	1152	1380	WGP3B046052...
606	676	351	7	1113	1344	1610	WGP3B046060...
688	773	402	8	1272	1536	1840	WGP3B046068...
770	869	452	9	1431	1728	2070	WGP3B046077...
852	966	502	10	1590	1920	2300	WGP3B046085...
934	1063	552	11	1749	2112	2530	WGP3B046093...
1016	1159	602	12	1908	2304	2760	WGP3B046101...
1098	1256	653	13	2067	2496	2990	WGP3B046109...
1180	1352	703	14	2226	2688	3220	WGP3B046118...
1262	1449	753	15	2385	2880	3450	WGP3B046126...
1344	1546	803	16	2544	3072	3680	WGP3B046134...
1426	1642	853	17	2703	3264	3910	WGP3B046142...

↔ [mm]	75/65/20°C [W]	55/45/20°C [W]	Počet článků	Skupina 1 Cena bez DPH [EUR]	Skupina 2 Cena bez DPH [EUR]	Skupina 3 Cena bez DPH [EUR]	Kód produktu ... Kód konfigurace s. 385
520 ⇄ [mm] – Verze s nožkami NOVINKA							
80	97	50	1	159	192	230	WGP3F052008...
278	290	151	3	477	576	690	WGP3F052027...
360	386	201	4	636	768	920	WGP3F052036...
442	483	251	5	795	960	1150	WGP3F052044...
524	580	301	6	954	1152	1380	WGP3F052052...
606	676	351	7	1113	1344	1610	WGP3F052060...
688	773	402	8	1272	1536	1840	WGP3F052068...
770	869	452	9	1431	1728	2070	WGP3F052077...
852	966	502	10	1590	1920	2300	WGP3F052085...
934	1063	552	11	1749	2112	2530	WGP3F052093...
1016	1159	602	12	1908	2304	2760	WGP3F052101...
1098	1256	653	13	2067	2496	2990	WGP3F052109...
1180	1352	703	14	2226	2688	3220	WGP3F052118...
1262	1449	753	15	2385	2880	3450	WGP3F052126...
1344	1546	803	16	2544	3072	3680	WGP3F052134...
1426	1642	853	17	2703	3264	3910	WGP3F052142...

560 ⇄ [mm] – Verze nástěnná

80	119	63	1	182	207	272	WGP3B056008...
278	357	190	3	546	621	816	WGP3B056027...
360	476	253	4	728	828	1088	WGP3B056036...
442	595	316	5	910	1035	1360	WGP3B056044...
524	714	380	6	1092	1242	1632	WGP3B056052...
606	833	443	7	1274	1449	1904	WGP3B056060...
688	952	506	8	1456	1656	2176	WGP3B056068...
770	1071	569	9	1638	1863	2448	WGP3B056077...
852	1190	633	10	1820	2070	2720	WGP3B056085...
934	1309	696	11	2002	2277	2992	WGP3B056093...
1016	1428	759	12	2184	2484	3264	WGP3B056101...
1098	1547	822	13	2366	2691	3536	WGP3B056109...
1180	1666	886	14	2548	2898	3808	WGP3B056118...
1262	1785	949	15	2730	3105	4080	WGP3B056126...
1344	1904	1012	16	2912	3312	4352	WGP3B056134...
1426	2023	1075	17	3094	3519	4624	WGP3B056142...

↔ [mm]	75/65/20°C [W]	55/45/20°C [W]	Počet článků	Skupina1 Cena bez DPH [EUR]	Skupina2 Cena bez DPH [EUR]	Skupina3 Cena bez DPH [EUR]	Kód produktu ... Kód konfigurace s.385
620 ⇄ [mm] – Verze s nožkami							
80	119	63	1	182	207	272	WGP3F062008...
278	357	190	3	546	621	816	WGP3F062027...
360	476	253	4	728	828	1088	WGP3F062036...
442	595	316	5	910	1035	1360	WGP3F062044...
524	714	380	6	1092	1242	1632	WGP3F062052...
606	833	443	7	1274	1449	1904	WGP3F062060...
688	952	506	8	1456	1656	2176	WGP3F062068...
770	1071	569	9	1638	1863	2448	WGP3F062077...
852	1190	633	10	1820	2070	2720	WGP3F062085...
934	1309	696	11	2002	2277	2992	WGP3F062093...
1016	1428	759	12	2184	2484	3264	WGP3F062101...
1098	1547	822	13	2366	2691	3536	WGP3F062109...
1180	1666	886	14	2548	2898	3808	WGP3F062118...
1262	1785	949	15	2730	3105	4080	WGP3F062126...
1344	1904	1012	16	2912	3312	4352	WGP3F062134...
1426	2023	1075	17	3094	3519	4624	WGP3F062142...
660 ⇄ [mm] – Verze nástěnná							
80	138	72	1	216	245	324	WGP3B066008...
278	414	217	3	648	735	972	WGP3B066027...
360	552	290	4	864	980	1296	WGP3B066036...
442	690	362	5	1080	1225	1620	WGP3B066044...
524	828	435	6	1296	1470	1944	WGP3B066052...
606	966	507	7	1512	1715	2268	WGP3B066060...
688	1104	580	8	1728	1960	2592	WGP3B066068...
770	1242	652	9	1944	2205	2916	WGP3B066077...
852	1380	725	10	2160	2450	3240	WGP3B066085...
934	1518	797	11	2376	2695	3564	WGP3B066093...
1016	1656	870	12	2592	2940	3888	WGP3B066101...
1098	1794	942	13	2808	3185	4212	WGP3B066109...
1180	1932	1015	14	3024	3430	4536	WGP3B066118...
1262	2070	1087	15	3240	3675	4860	WGP3B066126...
1344	2208	1160	16	3456	3920	5184	WGP3B066134...
1426	2346	1232	17	3672	4165	5508	WGP3B066142...
720 ⇄ [mm] – Verze s nožkami							
80	138	72	1	216	245	324	WGP3F072008...
278	414	217	3	648	735	972	WGP3F072027...
360	552	290	4	864	980	1296	WGP3F072036...
442	690	362	5	1080	1225	1620	WGP3F072044...
524	828	435	6	1296	1470	1944	WGP3F072052...
606	966	507	7	1512	1715	2268	WGP3F072060...
688	1104	580	8	1728	1960	2592	WGP3F072068...
770	1242	652	9	1944	2205	2916	WGP3F072077...
852	1380	725	10	2160	2450	3240	WGP3F072085...
934	1518	797	11	2376	2695	3564	WGP3F072093...

↔ [mm]	75/65/20°C [W]	55/45/20°C [W]	Počet článků	Skupina1 Cena bez DPH [EUR]	Skupina2 Cena bez DPH [EUR]	Skupina3 Cena bez DPH [EUR]	Kód produktu ... Kód konfigurace s.385
1016	1656	870	12	2592	2940	3888	WGP3F072101...
1098	1794	942	13	2808	3185	4212	WGP3F072109...
1180	1932	1015	14	3024	3430	4536	WGP3F072118...
1262	2070	1087	15	3240	3675	4860	WGP3F072126...
1344	2208	1160	16	3456	3920	5184	WGP3F072134...
1426	2346	1232	17	3672	4165	5508	WGP3F072142...

860 ⇄ [mm] – Verze nástěnná

80	176	92	1	262	298	396	WGP3B086008...
278	528	277	3	786	894	1188	WGP3B086027...
360	704	369	4	1048	1192	1584	WGP3B086036...
442	880	462	5	1310	1490	1980	WGP3B086044...
524	1056	554	6	1572	1788	2376	WGP3B086052...
606	1232	647	7	1834	2086	2772	WGP3B086060...
688	1408	739	8	2096	2384	3168	WGP3B086068...
770	1584	831	9	2358	2682	3564	WGP3B086077...
852	1760	924	10	2620	2980	3960	WGP3B086085...
934	1936	1016	11	2882	3278	4356	WGP3B086093...
1016	2112	1108	12	3144	3576	4752	WGP3B086101...
1098	2288	1201	13	3406	3874	5148	WGP3B086109...
1180	2464	1293	14	3668	4172	5544	WGP3B086118...
1262	2640	1385	15	3930	4470	5940	WGP3B086126...
1344	2816	1478	16	4192	4768	6336	WGP3B086134...
1426	2992	1570	17	4454	5066	6732	WGP3B086142...

920 ⇄ [mm] – Verze s nožkami

80	176	92	1	262	298	396	WGP3F092008...
278	528	277	3	786	894	1188	WGP3F092027...
360	704	369	4	1048	1192	1584	WGP3F092036...
442	880	462	5	1310	1490	1980	WGP3F092044...
524	1056	554	6	1572	1788	2376	WGP3F092052...
606	1232	647	7	1834	2086	2772	WGP3F092060...
688	1408	739	8	2096	2384	3168	WGP3F092068...
770	1584	831	9	2358	2682	3564	WGP3F092077...
852	1760	924	10	2620	2980	3960	WGP3F092085...
934	1936	1016	11	2882	3278	4356	WGP3F092093...
1016	2112	1108	12	3144	3576	4752	WGP3F092101...
1098	2288	1201	13	3406	3874	5148	WGP3F092109...
1180	2464	1293	14	3668	4172	5544	WGP3F092118...
1262	2640	1385	15	3930	4470	5940	WGP3F092126...
1344	2816	1478	16	4192	4768	6336	WGP3F092134...
1426	2992	1570	17	4454	5066	6732	WGP3F092142...

Plain Towel Rail



DOPORUČUJEME PRO PŘIPOJENÍ AX:



Sada rohová regulační "Mini-malist", Chrom

TGZR017: 228 EUR

Stránka: 344



Sada krycí dvojitá, Chrom

TGPCR004: 33 EUR

Stránka: 346



RADIÁTOR VODNÍ:

Připojení:



SKUPINY BAREV A VYKONČENÍ:

Skupina 1 – Raw Metal, Metal Alive, 190 barev RAL, White Soft, Frost, Metallic Brown, Autumn, Evening Garden, Shadow Gold, Graff i Flat Black

Skupina 2 – Full Burnish, Shaded Burnish, Antique Brass, Antique Copper, Bottle Green, Red Wine, Midnight

Skupina 3 – Ornament Gold, Ornament Silver, Ornament Copper, Galvanic Copper, Polished Metal

Rámová konstrukce radiátoru v barvách RAL, barvách Premium nebo Chrom. Případně v barvách Skupiny 1 a Skupiny 2 kromě Full i Shaded Burnish.

A ↕ [mm]	B ↔ [mm]	75/65/20°C [W]	55/45/20°C [W]	Skupina 1 Cena bez DPH [EUR]	Skupina 2 Cena bez DPH [EUR]	Skupina 3 Cena bez DPH [EUR]	Kód produktu ... Kód konfigurace s.385
900	490	357	190	911	984	1165	WGNT090049...
900	650	595	317	1155	1278	1578	WGNT090065...
900	820	834	445	1444	1616	2036	WGNT090082...
1000	490	416	221	1012	1096	1300	WGNT100049...
1000	650	694	368	1312	1452	1792	WGNT100065...
1200	490	619	324	1188	1293	1523	WGNT120049...
1200	650	1031	539	1538	1711	2096	WGNT120065...

Stylos



SADA OBSAHUJE:

Radiátor je prodáván v ceně spolu se třemi redukcemi, jednou euro zátkou, odvzdušňovacím ventilem, háky do zdi a stěhovacími pásy.

DOPORUČUJEME PRO PŘIPOJENÍ LP:



Sada regulační termostatická „Artistic“ – Antracit

TGETAN002: 190 EUR

Stránka: 345



Sada krycí dvojitá „Artistic“ – Antracit

TGPAN001: 64 EUR

Stránka: 346

RADIÁTOR VODNÍ:

Připojení:



SKUPINY BAREV A VYKONČENÍ:

Skupina 1 – Raw Metal, Metal Alive, 190 barev RAL, White Soft, Frost, Metallic Brown, Autumn, Evening Garden, Shadow Gold, Graff i Flat Black

Skupina 2 – Full Burnish, Shaded Burnish, Antique Brass, Antique Copper, Bottle Green, Red Wine, Midnight

Skupina 3 – Ornament Gold, Ornament Silver, Ornament Copper, Galvanic Copper, Polished Metal

V tabulkách jsou pouze ukázkové sestavy do 20 článků. Lze objednat i delší radiátory ve více sestavách a ty spojit až na místě. Radiátor 20 článků je možné ještě dodat vcelku na delší paletě.

↔ [mm]	75/65/20°C [W]	55/45/20°C [W]	Počet článků	Skupina 1 Cena bez DPH [EUR]	Skupina 2 Cena bez DPH [EUR]	Skupina 3 Cena bez DPH [EUR]	Kód produktu ... Kód konfigurace s. 385
-----------	-------------------	-------------------	-----------------	---------------------------------	---------------------------------	---------------------------------	--------------------------------------------

600 ↓ [mm] – Verze nástěnná

216	256	135	3	255	315	405	WG4SB060021...
277	341	180	4	340	420	540	WG4SB060027...
339	427	225	5	425	525	675	WG4SB060033...
400	512	270	6	510	630	810	WG4SB060040...
462	597	315	7	595	735	945	WG4SB060046...
523	682	360	8	680	840	1080	WG4SB060052...
585	768	405	9	765	945	1215	WG4SB060058...
646	853	450	10	850	1050	1350	WG4SB060064...
708	938	495	11	935	1155	1485	WG4SB060070...
769	1024	540	12	1020	1260	1620	WG4SB060076...
831	1109	585	13	1105	1365	1755	WG4SB060083...
892	1194	630	14	1190	1470	1890	WG4SB060089...
954	1280	675	15	1275	1575	2025	WG4SB060095...
1015	1365	720	16	1360	1680	2160	WG4SB060101...
1077	1450	765	17	1445	1785	2295	WG4SB060107...
1138	1535	810	18	1530	1890	2430	WG4SB060113...
1200	1621	855	19	1615	1995	2565	WG4SB060120...
1261	1706	900	20	1700	2100	2700	WG4SB060126...

↔ [mm]	75/65/20°C [W]	55/45/20°C [W]	Počet článků	Skupina 1 Cena bez DPH [EUR]	Skupina 2 Cena bez DPH [EUR]	Skupina 3 Cena bez DPH [EUR]	Kód produktu ... Kód konfigurace s.385
660 ⇄ [mm] – Verze s nožkami							
216	256	135	3	255	315	405	WG4SF066021...
277	341	180	4	340	420	540	WG4SF066027...
339	427	225	5	425	525	675	WG4SF066033...
400	512	270	6	510	630	810	WG4SF066040...
462	597	315	7	595	735	945	WG4SF066046...
523	682	360	8	680	840	1080	WG4SF066052...
585	768	405	9	765	945	1215	WG4SF066058...
646	853	450	10	850	1050	1350	WG4SF066064...
708	938	495	11	935	1155	1485	WG4SF066070...
769	1024	540	12	1020	1260	1620	WG4SF066076...
831	1109	585	13	1105	1365	1755	WG4SF066083...
892	1194	630	14	1190	1470	1890	WG4SF066089...
954	1280	675	15	1275	1575	2025	WG4SF066095...
1015	1365	720	16	1360	1680	2160	WG4SF066101...
1077	1450	765	17	1445	1785	2295	WG4SF066107...
1138	1535	810	18	1530	1890	2430	WG4SF066113...
1200	1621	855	19	1615	1995	2565	WG4SF066120...
1261	1706	900	20	1700	2100	2700	WG4SF066126...
700 ⇄ [mm] – Verze nástěnná							
216	307	159	3	285	345	435	WG4SB070021...
277	410	212	4	380	460	580	WG4SB070027...
339	512	265	5	475	575	725	WG4SB070033...
400	614	317	6	570	690	870	WG4SB070040...
462	717	370	7	665	805	1015	WG4SB070046...
523	819	423	8	760	920	1160	WG4SB070052...
585	922	476	9	855	1035	1305	WG4SB070058...
646	1024	529	10	950	1150	1450	WG4SB070064...
708	1126	582	11	1045	1265	1595	WG4SB070070...
769	1229	635	12	1140	1380	1740	WG4SB070076...
831	1331	688	13	1235	1495	1885	WG4SB070083...
892	1434	741	14	1330	1610	2030	WG4SB070089...
954	1536	794	15	1425	1725	2175	WG4SB070095...
1015	1638	846	16	1520	1840	2320	WG4SB070101...
1077	1741	899	17	1615	1955	2465	WG4SB070107...
1138	1843	952	18	1710	2070	2610	WG4SB070113...
1200	1946	1005	19	1805	2185	2755	WG4SB070120...
1261	2048	1058	20	1900	2300	2900	WG4SB070126...
760 ⇄ [mm] – Verze s nožkami							
216	307	159	3	285	345	435	WG4SF076021...
277	410	212	4	380	460	580	WG4SF076027...
339	512	265	5	475	575	725	WG4SF076033...
400	614	317	6	570	690	870	WG4SF076040...
462	717	370	7	665	805	1015	WG4SF076046...
523	819	423	8	760	920	1160	WG4SF076052...
585	922	476	9	855	1035	1305	WG4SF076058...
646	1024	529	10	950	1150	1450	WG4SF076064...
708	1126	582	11	1045	1265	1595	WG4SF076070...
769	1229	635	12	1140	1380	1740	WG4SF076076...
831	1331	688	13	1235	1495	1885	WG4SF076083...
892	1434	741	14	1330	1610	2030	WG4SF076089...
954	1536	794	15	1425	1725	2175	WG4SF076095...
1015	1638	846	16	1520	1840	2320	WG4SF076101...
1077	1741	899	17	1615	1955	2465	WG4SF076107...
1138	1843	952	18	1710	2070	2610	WG4SF076113...
1200	1946	1005	19	1805	2185	2755	WG4SF076120...
1261	2048	1058	20	1900	2300	2900	WG4SF076126...

Aero V



Barva je zahrnuta v ceně



výběr připojení v ceně

DOPORUČUJEME PRO PŘIPOJENÍ ZX:



Integrovaná sada termostatická, Chrom

WRZT5G1-CR: 145 EUR

WRZT5G2-CR: 145 EUR

Stránka: 332

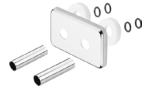

Sada krycí integrovaná, Chrom

TGPCR002: 38 EUR

Stránka: 374

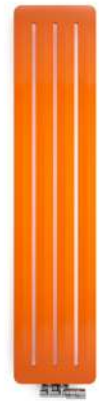

RADIÁTOR VODNÍ

Připojení:



A ⇕ [mm]	B ⇔ [mm]	75/65/20°C [W]	55/45/20°C [W]	Barvy RAL a speciální barvy Cena bez DPH [EUR]	Kód produktu ... Kód konfigurace s. 385
900	325	286	149	579	WGARV090032...
1200	325	366	190	608	WGARV120032...
1200	410	458	237	637	WGARV120041...
1500	325	446	229	637	WGARV150032...
1500	410	558	286	665	WGARV150041...
1800	325	526	268	680	WGARV180032...
1800	410	657	334	723	WGARV180041...

Aero H



Barva je zahrnuta v ceně



výběr připojení v ceně

DOPORUČUJEME PRO PŘIPOJENÍ YL i YP:



Integrovaná sada termostatická, Chrom

WRZT5G1-CR: 145 EUR

WRZT5G2-CR: 145 EUR

Stránka: 332



Háček bodový YO!

WRWYOY001*: 4 EUR

Stránka: 316



Háček bodový HANDY VIP,

Chrom, Sada obsahuje dva háčky

TGWCR005: 23 EUR

Stránka: 314



Sada krycí integrovaná,

Chrom

TGPCR002: 38 EUR

Stránka: 374

RADIÁTOR VODNÍ

Připojení:



A ↕ [mm]	B ↔ [mm]	75/65/20°C [W]	55/45/20°C [W]	Barvy RAL a speciální barvy Cena bez DPH [EUR]	Kód produktu ... Kód konfigurace s. 385
325	900	290	160	579	WGARH032090...
325	1200	388	214	608	WGARH032120...
325	1500	485	267	637	WGARH032150...
325	1800	582	320	680	WGARH032180...
410	1200	480	265	637	WGARH041120...
410	1500	600	330	665	WGARH041150...
410	1800	720	396	723	WGARH041180...

Aero HG



Barva je zahrnuta v ceně



výběr připojení v ceně

DOPORUČUJEME PRO PŘIPOJENÍ YL i YP:



Integrovaná sada termostatická, Chrom

WRZT5G1-CR: 145 EUR

WRZT5G2-CR: 145 EUR

Stránka: 332



Háček bodový YO!

WRWYOY001*: 4 EUR

Stránka: 316



Háček bodový HANDY VIP,

Chrom, Sada obsahuje dva háčky

TGWCR005: 23 EUR

Stránka: 314



Sada krycí integrovaná,

Chrom

TGPCR002: 38 EUR

Stránka: 374

RADIÁTOR VODNÍ

Připojení:



A \updownarrow [mm]	B \leftrightarrow [mm]	75/65/20°C [W]	55/45/20°C [W]	Barvy RAL a speciální barvy Cena bez DPH [EUR]	Kód produktu ... Kód konfigurace s. 385
370	900	290	160	579	WGARG037090...
370	1200	388	214	608	WGARG037120...
370	1500	485	267	637	WGARG037150...
370	1800	582	320	680	WGARG037180...
455	1200	480	265	637	WGARG045120...
455	1500	600	330	665	WGARG045150...
455	1800	720	396	723	WGARG045180...



Barva je zahrnuta v ceně

výběr připojení v ceně

DOPORUČUJEME PRO PŘIPOJENÍ Z1 i Z8:



Integrovaná sada termostatická, Chrom

WRZT5G1-CR: 145 EUR
 WRZT5G2-CR: 145 EUR

Stránka: 332

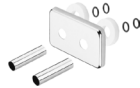

Sada krycí integrovaná, Chrom

TGPCR002: 38 EUR

Stránka: 374



Topná tyč MOA, Chrom

WEMOA*: 105 EUR

Stránka: 295



Háček bodový YO!

WRWYOY001*: 4 EUR

Stránka: 316



RADIÁTOR VODNÍ / VODNĚ-ELEKTRICKÝ (DOKOUPIT TOPNOU TYČ)

Připojení:

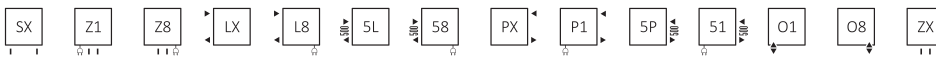

A ↓ [mm]	B ↔ [mm]	Barva ze vzorníku RAL a speciálních barev			Galvanický povrch Chrom			Barvy RAL a speciální barvy Cena bez DPH [EUR]	Chrom Cena bez DPH [EUR]	Kód produktu ... Kód konfigurace s. 385
		75/65/20°C [W]	55/45/20°C [W]	[W]	75/65/20°C [W]	55/45/20°C [W]	[W]			
540	300	180	99	200	126	64	120	178	266	WGALE054030...
540	400	238	129	200	167	85	200	183	287	WGALE054040...
540	500	299	161	300	209	107	200	188	307	WGALE054050...
540	600	355	190	400	249	127	300	194	325	WGALE054060...
760	300	257	137	300	180	92	200	194	324	WGALE076030...
760	400	330	177	300	231	118	200	201	351	WGALE076040...
760	500	412	220	400	288	147	300	211	378	WGALE076050...
760	600	481	257	600	337	172	400	225	408	WGALE076060...
1140	300	362	194	400	253	129	300	228	432	WGALE114030...
1140	400	479	194	400	335	171	400	244	479	WGALE114040...
1140	500	591	313	600	414	211	400	260	523	WGALE114050...
1140	600	711	380	800	498	254	600	279	566	WGALE114060...
1580	500	793	425	800	555	283	600	307	668	WGALE158050...
1580	600	949	508	1000	664	339	600	328	726	WGALE158060...
1580	700	1104	591	1000	773	394	800	350	788	WGALE158070...
1580	800	1253	670	1200	–	–	–	373	–	WGALE158080...

Alex E



Barva je zahrnuta v ceně



výběr připojení v ceně

RADIÁTOR ELEKTRICKÝ (CENA VČETNĚ NÁPLNĚ A ZVOLENÉ TOPNÉ TYČE)

Připojení:



A ↓ [mm]	B ↔ [mm]	Výkon [W]		MEG Cena bez DPH [EUR]		MOA/DRY/TDY Cena bez DPH [EUR] (MOA IR: + 12 EUR) (MOA BLUE: + 38 EUR)		ONE Cena bez DPH [EUR] (Nezabudovaná, v 8cm profilu v barvě radiátoru)		REG 2 Cena bez DPH [EUR]		REG 3 Cena bez DPH [EUR]		SIM Cena bez DPH [EUR]		Terma Split třída I Cena bez DPH [EUR] (nezapomeňte si koupit regulátor KTX)		Smart Split třída I Cena bez DPH [EUR] (nezapomeňte si koupit SMART Wi-Fi regulátor VEO)		Kód produktu ... Kód konfigurace s. 388
		Barva	Chrom	Barvy RAL a speciální barvy	Chrom	Barvy RAL a speciální barvy	Chrom	Barvy RAL a speciální barvy	Chrom	Barvy RAL a speciální barvy	Chrom	Barvy RAL a speciální barvy	Chrom	Barvy RAL a speciální barvy	Chrom	Barvy RAL a speciální barvy	Chrom	Barvy RAL a speciální barvy	Chrom	
540	300	200	120	273	361	280	368	300	388	250	339	260	349	241	329	226	314	226	314	WLALE054030...
540	400	200	200	277	381	285	388	305	408	255	359	265	368	246	349	231	334	231	334	WLALE054040...
540	500	300	200	282	402	290	409	309	429	260	380	270	389	250	370	236	355	236	355	WLALE054050...
540	600	400	300	289	420	296	427	316	447	266	398	276	408	257	388	242	373	242	373	WLALE054060...
760	300	300	200	289	419	296	426	316	446	266	397	276	407	257	387	242	372	242	372	WLALE076030...
760	400	300	200	296	446	303	453	323	473	274	424	284	434	264	414	249	399	249	399	WLALE076040...
760	500	400	300	306	473	313	480	333	500	284	451	293	461	274	441	259	426	259	426	WLALE076050...
760	600	600	400	319	502	327	510	346	530	297	480	307	490	287	471	273	456	273	456	WLALE076060...
1140	300	400	300	323	527	330	534	350	554	301	505	311	515	291	495	276	480	276	480	WLALE114030...
1140	400	400	400	339	574	346	581	366	601	317	552	327	562	307	542	292	527	292	527	WLALE114040...
1140	500	600	400	355	618	362	625	382	645	333	596	343	606	323	586	308	571	308	571	WLALE114050...
1140	600	800	600	373	661	381	668	400	688	351	639	361	649	341	629	327	614	327	614	WLALE114060...
1580	500	800	600	402	763	409	771	429	790	380	741	389	751	370	731	355	716	355	716	WLALE158050...
1580	600	1000	600	423	821	430	828	450	848	400	799	410	809	391	789	376	774	376	774	WLALE158060...
1580	700	1000	800	445	882	452	890	472	909	423	860	432	870	413	850	398	836	398	836	WLALE158070...
1580	800	1200	-	468	-	475	-	495	-	446	-	456	-	436	-	421	-	421	-	WLALE158080...

Alex One



Barva je zahrnuta v ceně



výběr připojení v ceně



TŘÍDA I



45-60°C/2



P-W-U



120-1000W



IR



Radiátor se zabudovanou topnou tyčí One. Funkce topné tyče ONE: Stránka 287.

DOPORUČUJEME PRO PŘIPOJENÍ S1 i S8:



Integrovaná sada termos-tatická s ponornou trubicí,
Chrom



WRZT5G5-CR: 151 EUR



WRZT5G6-CR: 151 EUR

Stránka: 334



Sada krycí integrovaná,
Chrom
TGPCR002: 38 EUR
Stránka: 374



Regulátor TTIR1
TGRTBI001: 104 EUR
Stránka: 304



Háček bodový YO!
WRWYOY001*: 4 EUR
Stránka: 316

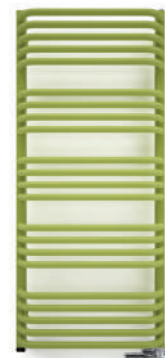

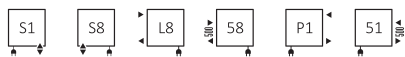

RADIÁTOR VODNĚ-ELEKTRICKÝ (CENA VČETNĚ ZABUDOVANÉ TOPNÉ TYČE ONE)

Připojení:

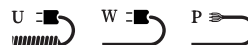

Vyber druh kabelu:



A ↑ [mm]	B ↔ [mm]	Barva ze vzorníku RAL a speciálních barev			Galvanický povrch Chrom			Barvy RAL a speciální barvy Cena bez DPH [EUR]	Chrom Cena bez DPH [EUR]	Kód produktu ... Kód konfigurace s. 386
		75/65/20°C [W]	55/45/20°C [W]	 [W]	75/65/20°C [W]	55/45/20°C [W]	 [W]			
760	300	257	137	300	180	92	200	291	421	WZALN076030...
760	400	330	177	300	231	118	200	298	448	WZALN076040...
760	500	412	220	400	288	147	300	308	475	WZALN076050...
760	600	481	257	600	337	172	400	322	505	WZALN076060...
1140	300	362	194	400	253	129	300	325	530	WZALN114030...
1140	400	479	257	400	335	171	400	341	576	WZALN114040...
1140	500	591	313	600	414	211	400	357	621	WZALN114050...
1140	600	711	380	800	498	254	600	376	664	WZALN114060...
1580	500	793	425	800	555	283	600	404	766	WZALN158050...
1580	600	949	508	1000	664	339	600	425	823	WZALN158060...
1580	700	1104	591	1000	773	394	800	-	-	WZALN158070...

Alex One E



Barva je zahrnuta v ceně



výběr připojení v ceně



TŘÍDA I



45-60°C/2



P-W-U



120-1000W



IR



IPx5



2h/1



RADIÁTOR ELEKTRICKÝ (CENA VČETNĚ NÁPLNĚ A ZABUDOVANÉ TOPNÉ TYČE ONE)

Připojení:



A ⇕ [mm]	B ↔ [mm]	Výkon [W]		Barvy RAL a speciální barvy Cena bez DPH [EUR]	Chrom Cena bez DPH [EUR]	Kód produktu ... Kód konfigurace s. 387
		Barva	Chrom			
760	300	300	200	309	440	WWALN076030...
760	400	300	200	317	467	WWALN076040...
760	500	400	300	327	494	WWALN076050...
760	600	600	400	340	523	WWALN076060...
1140	300	400	300	344	548	WWALN114030...
1140	400	400	400	360	595	WWALN114040...
1140	500	600	400	376	639	WWALN114050...
1140	600	800	600	394	682	WWALN114060...
1580	500	800	600	423	784	WWALN158050...
1580	600	1000	600	443	842	WWALN158060...
1580	700	1000	800	-	-	WWALN158070...

Angus V



Barva je zahrnuta v ceně

výběr připojení v ceně

DOPORUČUJEME PRO PŘIPOJENÍ ZX, Y1, Y8, YL i YP:



Integrovaná sada termostatická,
Chrom

WRZT5G1-CR: 145 EUR

WRZT5G2-CR: 145 EUR

Stránka: 332



Sada krycí integrovaná, Chrom

TGPCR002: 38 EUR

Stránka: 374



Háček bodový ZIP V 30, Chrom

WRWZIP012 KCRO 44 EUR

Stránka: 317



RADIÁTOR VODNÍ / VODNĚ-ELEKTRICKÝ (DOKOUPIT TOPNOU TYČ)

Připojení:



A ↕ [mm]	B ↔ [mm]	75/65/20°C [W]	55/45/20°C [W]	[W]	Barvy RAL a speciální barvy Cena bez DPH [EUR]	Kód produktu ... Kód konfigurace s. 385
1140	360	421	224	400	405	WGANG114036...
1300	440	557	293	600	462	WGANG130044...
1460	520	711	372	800	548	WGANG146052...
1620	600	905	472	1000	606	WGANG162060...
1780	680	1116	580	1200	692	WGANG178068...

Angus V E



Barva je zahrnuta v ceně



výběr připojení v ceně

DOPORUČUJEME:



Háček bodový ZIP V 30,

Chrom

WRWZIP012 KCRO 44 EUR

Stránka: 317



RADIÁTOR ELEKTRICKÝ (CENA VČETNĚ NÁPLNĚ A ZVOLENÉ TOPNÉ TYČE)

Připojení:



A ↕ [mm]	B ↔ [mm]	Výkon [W]	MEG Cena bez DPH [EUR]	MOA/DRY/ TDY Cena bez DPH [EUR] (MOA IR: + 12 EUR) (MOA BLUE: + 38 EUR)	ONE Cena bez DPH [EUR] (Nezabudovaná, v 8cm profilu v barvě radiátoru)	REG 2 Cena bez DPH [EUR]	REG 3 Cena bez DPH [EUR]	SIM Cena bez DPH [EUR]	Terma Split třída I Cena bez DPH [EUR] (nezapomeňte si koupit regulátor KTX)	Smart Split třída I Cena bez DPH [EUR] (nezapomeňte si koupit SMART WI-FI regulátor VEO)	Kód produktu ... Kód konfigurace s. 388
1140	360	400	500	507	527	478	488	468	453	453	WLANG114036...
1300	440	600	557	564	584	534	544	525	510	510	WLANG130044...
1460	520	800	643	650	670	621	630	611	596	596	WLANG146052...
1620	600	1000	700	708	728	678	688	668	654	654	WLANG162060...
1780	680	1200	787	794	-	764	774	755	-	740	WLANG178068...

Angus DW (dělicí stěna kolmá)



Barva je zahrnuta v ceně

výběr připojení v ceně

DOPORUČUJEME PRO PŘIPOJENÍ ZX, Y1, Y8, YL i YP:



Integrovaná sada termostatická,
Chrom

 WRZT5G3-CR: 146 EUR

 WRZT5G4-CR: 146 EUR

Stránka: 332



Sada krycí integrovaná, Chrom

TGPCR002: 38 EUR

Stránka: 374



Háček bodový ZIP V 30, Chrom

WRWZIP012 KCRO: 44 EUR

Stránka: 317



RADIÁTOR VODNÍ / VODNĚ-ELEKTRICKÝ (DOKOUPIT TOPNOU TYČ)

Připojení:



A ↑ [mm]	B ↔ [mm]	75/65/20°C [W]	55/45/20°C [W]	 [W]	Barvy RAL a speciální barvy Cena bez DPH [EUR]	Kód produktu ... Kód konfigurace s. 385
1140	360	421	224	400	511	WGANS114036...
1300	440	557	293	600	553	WGANS130044...
1460	520	711	372	800	623	WGANS146052...
1620	600	905	472	1000	680	WGANS162060...
1780	680	1116	580	1200	764	WGANS178068...

Angus DW E (dělicí stěna kolmá)



Barva je zahrnuta v ceně



výběr připojení v ceně

DOPORUČUJEME:



Háček bodový ZIP V 30,

Chrom

WRWZIP012 KCRO: 44 EUR

Stránka: 317

RADIÁTOR ELEKTRICKÝ (CENA VČETNĚ NÁPLNĚ A ZVOLENÉ TOPNÉ TYČE)

Připojení:

E1



A ↕ [mm]	B ↔ [mm]	Výkon [W]	MEG Cena bez DPH [EUR]	MOA/DRY/ TDY Cena bez DPH [EUR] (MOA IR: +12 EUR) (MOA BLUE: +38 EUR)	ONE Cena bez DPH [EUR] (Nezabudovaná, v 8cm profilu v barvě radiátoru)	REG 2 Cena bez DPH [EUR]	REG 3 Cena bez DPH [EUR]	SIM Cena bez DPH [EUR]	Terma Split třída I Cena bez DPH [EUR] (nezapomeňte si koupit regulátor KTX)	Smart Split třída I Cena bez DPH [EUR] (nezapomeňte si koupit SMART Wi-Fi regulátor VEO)	Kód produktu ... Kód konfigurace s. 388
1140	360	400	606	613	633	584	593	574	559	559	WLANS114036...
1300	440	600	648	655	675	625	635	616	601	601	WLANS130044...
1460	520	800	718	725	745	696	705	686	671	671	WLANS146052...
1620	600	1000	774	782	801	752	762	742	728	728	WLANS162060...
1780	680	1200	858	865	885	836	846	826	811	811	WLANS178068...

Angus H



Barva je zahrnuta v ceně

výběr připojení v ceně

DOPORUČUJEME PRO PŘIPOJENÍ YL, YP, Y7 i Y2:



Integrovaná sada termostatická, Chrom

WRZT5G1-CR: 145 EUR

WRZT5G2-CR: 145 EUR

Stránka: 332



Sada krycí integrovaná, Chrom

TGPCR002: 38 EUR

Stránka: 374



Topná tyč KTX3, Chrom

WEKT3*: 129 EUR

Stránka: 290



RADIÁTOR VODNÍ / VODNĚ-ELEKTRICKÝ (DOKOUPIT TOPNOU TYČ)

Připojení:

Výška [mm] 360÷680:

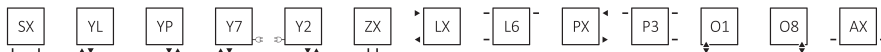

Výška [mm] 600÷680:



A ↕ [mm]	B ↔ [mm]	75/65/20°C [W]	55/45/20°C [W]	[W]	Barvy RAL a speciální barvy Cena bez DPH [EUR]	Kód produktu ... Kód konfigurace s. 385
360	1140	416	227	400	405	WGANH036114...
440	1300	538	292	600	462	WGANH044130...
520	1460	680	366	800	548	WGANH052146...
600	1620	841	449	800	606	WGANH060162...
680	1780	1022	540	1000	692	WGANH068178...

Angus H E



Barva je zahrnuta v ceně



výběr připojení v ceně

RADIÁTOR ELEKTRICKÝ (CENA VČETNĚ NÁPLNĚ A ZVOLENÉ TOPNÉ TYČE)

Připojení:

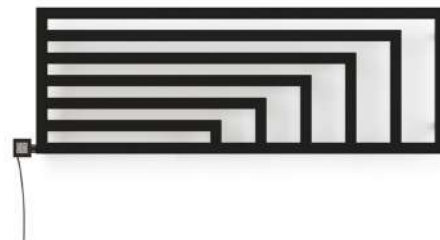

A ↕ [mm]	B ↔ [mm]	Výkon [W]	MEG Cena bez DPH [EUR]	MOA/DRY/ TDY Cena bez DPH [EUR] (MOA IR: +12 EUR) (MOA BLUE: +38 EUR)	ONE Cena bez DPH [EUR] (Nezabudovaná, v 8cm profilu v barvě radiátoru)	REG 2 Cena bez DPH [EUR]	REG 3 Cena bez DPH [EUR]	SIM Cena bez DPH [EUR]	Terma Split třída I Cena bez DPH [EUR] (nezapomeňte si koupit regulátor KTX)	Smart Split třída I Cena bez DPH [EUR] (nezapomeňte si koupit SMARTWi-Fi regulátor VEO)	Kód produktu ... Kód konfigurace s. 388
360	1140	400	500	507	527	478	488	468	453	453	WLANH036114...
440	1300	600	557	564	584	534	544	525	510	510	WLANH044130...
520	1460	800	643	650	670	621	630	611	596	596	WLANH052146...
600	1620	800	700	708	728	678	688	668	654	654	WLANH060162...
680	1780	1000	787	794	814	764	774	755	740	740	WLANH068178...

Bookie

  Barva je zahrnuta v ceně

DOPORUČUJEME PRO PŘIPOJENÍ ZX:



Integrovaná sada termostatická,

Chrom

 WRZT5G1-CR: 145 EUR

 WRZT5G2-CR: 145 EUR

Stránka: 332



Sada krycí integrovaná, Chrom

TGPCR002: 38 EUR

Stránka: 374



Police Bookie

WRPBUK030 KBUK: 40 EUR

WRPDAB030 KDAB: 54 EUR

WRPTEAK030 KTEK: 116 EUR

Stránka: 310



RADIÁTOR VODNÍ

Připojení:



A ↕ [mm]	B ↔ [mm]	75/65/20°C [W]	55/45/20°C [W]	Barvy RAL a speciální barvy Cena bez DPH [EUR]	Kód produktu ... Kód konfigurace s. 385
655	300	246	133	429	WGBUK065030...
655	400	308	166	438	WGBUK065040...
655	500	370	199	447	WGBUK065050...
1155	300	420	226	594	WGBUK115030...
1155	400	515	278	617	WGBUK115040...
1155	500	616	332	640	WGBUK115050...
1655	300	582	314	730	WGBUK165030...
1655	400	722	389	763	WGBUK165040...
1655	500	862	465	795	WGBUK165050...

Bone



DOPORUČUJEME PRO PŘIPOJENÍ ZX, Z1 i Z8:



Integrovaná sada termostatická, Chrom

WRZT5G1-CR: 145 EUR
WRZT5G2-CR: 145 EUR

Stránka: 332



Sada krycí integrovaná, Chrom

TGPCR002: 38 EUR

Stránka: 374



Háček bodový ZIP H 20, Chrom

WRWZIP010 KCRO: 42 EUR

Stránka: 316



Topná tyč ONE, Chrom



WEOPX*: 127 EUR

Stránka: 286

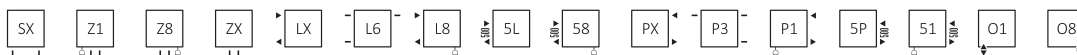

RADIÁTOR VODNÍ / VODNĚ-ELEKTRICKÝ (DOKOUPIT TOPNOU TYČ)



A ↑ [mm]	B ↔ [mm]	Barva ze vzorníku RAL a speciálních barev			Galvanický povrch Chrom			Barvy RAL a speciální barvy Cena bez DPH [EUR]	Chrom Cena bez DPH [EUR]	Kód produktu ... Kód konfigurace s. 385
		75/65/20°C [W]	55/45/20°C [W]	 [W]	75/65/20°C [W]	55/45/20°C [W]	 [W]			
760	500	320	173	300	224	121	200	248	397	WGBON076050...
760	600	384	208	400	269	145	300	255	427	WGBON076060...
1260	500	503	271	600	352	190	400	285	489	WGBON126050...
1260	600	603	325	600	422	227	400	297	549	WGBON126060...
1510	500	607	323	600	425	226	400	325	656	WGBON151050...
1510	600	728	387	800	510	271	600	339	734	WGBON151060...

Bone E



Barva je zahrnuta v ceně



výběr připojení v ceně

RADIÁTOR ELEKTRICKÝ (CENA VČETNĚ NÁPLNĚ A ZVOLENÉ TOPNÉ TYČE)

Připojení:



A ↓ [mm]	B ↔ [mm]	Výkon [W]		MEG		MOA/DRY/TDY		ONE		REG 2		REG 3		SIM		Terma Split třída I		Smart Split třída I		Kód produktu ... Kód konfigurace s. 388
				Cena bez DPH [EUR]		Cena bez DPH [EUR] (MOAIR: +12 EUR) (MOABLUE: +38 EUR)		Cena bez DPH [EUR] (Nezabudovaná, v 8cm profilu v barvě radiátoru)		Cena bez DPH [EUR]		Cena bez DPH [EUR]		Cena bez DPH [EUR]		Cena bez DPH [EUR] (nezapomeňte si koupit regulátor KTX)		Cena bez DPH [EUR] (nezapomeňte si koupit SMART Wi-Fi regulátor VEO)		
		Banva	Chrom	BanyRALa speciální banvy	Chrom	BanyRALa speciální banvy	Chrom	BanyRALa speciální banvy	Chrom	BanyRALa speciální banvy	Chrom	BanyRALa speciální banvy	Chrom	BanyRALa speciální banvy	Chrom	BanyRALa speciální banvy	Chrom	BanyRALa speciální banvy	Chrom	
760	500	300	200	343	491	350	499	370	518	321	469	330	479	311	459	296	445	296	445	WLBON076050...
760	600	400	300	350	522	357	530	377	549	328	500	338	510	318	490	303	475	303	475	WLBON076060...
1260	500	600	400	380	584	387	591	407	611	357	562	367	571	348	552	333	537	333	537	WLBON126050...
1260	600	600	400	392	644	399	651	419	671	370	622	380	632	360	612	345	597	345	597	WLBON126060...
1510	500	600	400	420	751	427	758	447	778	398	729	408	739	388	719	373	704	373	704	WLBON151050...
1510	600	800	600	434	828	441	836	461	855	412	806	421	816	402	796	387	782	387	782	WLBON151060...

Bone DW (dělicí stěna kolmá)

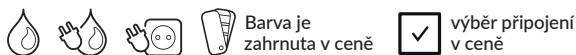

Barva je zahrnuta v ceně

výběr připojení v ceně

DOPORUČUJEME PRO PŘIPOJENÍ ZX i Z1:



Integrovaná sada termostatická,

Chrom

WRZT5G3-CR: 146 EUR

WRZT5G4-CR: 146 EUR

Stránka: 332



Sada krycí integrovaná, Chrom

TGPCR002: 38 EUR

Stránka: 374



Háček bodový ZIP H 20, Chrom

WRWZIP010 KCRO: 42 EUR

Stránka: 316



RADIÁTOR VODNÍ / VODNĚ-ELEKTRICKÝ (DOKOUPIT TOPNOU TYČ)

Připojení:



A ↕ [mm]	B ↔ [mm]	75/65/20°C [W]	55/45/20°C [W]	[W]	Barvy RAL a speciální barvy Cena bez DPH [EUR]	Kód produktu ... Kód konfigurace: 385
1610	500	607	323	600	447	WGBSD161050...
1910	500	764	404	800	485	WGBSD191050...

Bone DW E (dělicí stěna kolmá)



Barva je zahrnuta v ceně

výběr připojení v ceně

RADIÁTOR ELEKTRICKÝ (CENA VČETNĚ NÁPLNĚ A ZVOLENÉ TOPNÉ TYČE)

Připojení:



A ↕ [mm]	B ↕ [mm]	Výkon [W]	MEG Cena bez DPH [EUR]	MOA/DRY/TDY Cena bez DPH [EUR] (MOAIR: +12 EUR) (MOABLUE: +38 EUR)	ONE Cena bez DPH [EUR] (Nezabudovaná, v 8cm profilu v barvě radiátoru)	REG 2 Cena bez DPH [EUR]	REG 3 Cena bez DPH [EUR]	SIM Cena bez DPH [EUR]	Terma Split třída I Cena bez DPH [EUR] (nezapomeňte si koupit regulátor KTX)	Smart Split třída I Cena bez DPH [EUR] (nezapomeňte si koupit SMART Wi-Fi regulátor VEO)	Kód produktu ... Kód konfigurace s. 388
1610	500	600	542	549	569	520	530	510	495	495	WLBSD161050...
1910	500	800	580	587	607	558	568	548	533	533	WLBSD191050...

Bone One

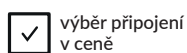

Radiátor se zabudovanou topnou tyčí One. Funkce topné tyče ONE: Stránka 287.

DOPORUČUJEME PRO PŘIPOJENÍ S1 i S8:



Integrovaná sada termos-
tatická s ponornou trubici,
Chrom

 WRZT5G5-CR: 151EUR

 WRZT5G6-CR: 151EUR

Stránka: 334



Sada krycí integrovaná,
Chrom

TGPCR002: 38EUR

Stránka: 374



Regulátor TTIR1

TGRTBI001: 104EUR

Stránka: 304



Háček bodový ZIP H 20,

Chrom

WRWZIP010 KCRO: 42EUR

Stránka: 316

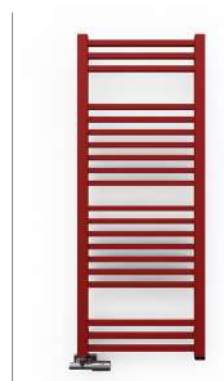

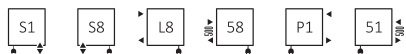

RADIÁTOR VODNĚ-ELEKTRICKÝ (CENA VČETNĚ ZABUDOVANÉ TOPNÉ TYČE ONE)

Připojení:

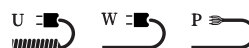

Vyber druh kabelu:



A ↑ [mm]	B ↔ [mm]	Barva ze vzorníku RAL a speciálních barev			Galvanický povrch Chrom			Barvy RAL a speciální barvy Cena bez DPH [EUR]	Chrom Cena bez DPH [EUR]	Kód produktu ... Kód konfigurace s. 386
		75/65/20°C [W]	55/45/20°C [W]	 [W]	75/65/20°C [W]	55/45/20°C [W]	 [W]			
760	500	320	173	300	224	121	200	345	494	WZBNN076050...
760	600	384	208	400	269	145	300	352	525	WZBNN076060...
1260	500	503	271	600	352	190	400	382	586	WZBNN126050...
1260	600	603	325	600	422	227	400	394	646	WZBNN126060...
1510	500	607	323	600	425	226	400	423	753	WZBNN151050...
1510	600	728	387	800	510	271	600	436	831	WZBNN151060...

Bone One E



Barva je zahrnuta v ceně



výběr připojení v ceně



TŘÍDA I



45-60°C/2



P-W-U



120-1000W



IR



2h/1



RADIÁTOR ELEKTRICKÝ (CENA VČETNĚ NÁPLNĚ A ZABUDOVANÉ TOPNÉ TYČE ONE)

Připojení:



A ↕ [mm]	B ↔ [mm]	Výkon [W]		Barvy RAL a speciální barvy Cena bez DPH [EUR]	Chrom Cena bez DPH [EUR]	Kód produktu ... Kód konfigurace s. 387
		Barva	Chrom			
760	500	300	200	364	512	WWBNN076050...
760	600	400	300	371	543	WWBNN076060...
1260	500	600	400	400	605	WWBNN126050...
1260	600	600	400	413	665	WWBNN126060...
1510	500	600	400	441	772	WWBNN151050...
1510	600	800	600	455	849	WWBNN151060...

Cane



Barva je zahrnuta v ceně



výběr připojení v ceně

DOPORUČUJEME PRO PŘIPOJENÍ Z1, Z8, Y1, Y8 i ZX:



Integrovaná sada termostatická, Chrom

WRZT5G1-CR: 145 EUR

WRZT5G2-CR: 145 EUR

Stránka: 332



Sada krycí integrovaná, Chrom

TGPCR002: 38 EUR

Stránka: 374



Regulátor TTIR1

TGRTBI001: 104 EUR

Stránka: 304



Topná tyč MOA IR, Chrom

WEMOR*: 117 EUR

Stránka: 294



RADIÁTOR VODNÍ / VODNĚ-ELEKTRICKÝ (DOKOUPIT TOPNOU TYČ)

Připojení:



A ↕ [mm]	B ↔ [mm]	75/65/20°C [W]	55/45/20°C [W]	 [W]	Barvy RAL a speciální barvy Cena bez DPH [EUR]	Kód produktu ... Kód konfigurace s. 385
1300	390	569	300	600	734	WGCAN130039...
1600	390	670	354	800	843	WGCAN160039...
1900	390	768	405	800	952	WGCAN190039...

Cane E



Barva je zahrnuta v ceně



výběr připojení v ceně

RADIÁTOR ELEKTRICKÝ (CENA VČETNĚ NÁPLNĚ A ZVOLENÉ TOPNÉ TYČE)

Připojení:

E1

E8



A ↕ [mm]	B ↔ [mm]	Výkon [W]	MEG Cena bez DPH [EUR]	MOA/DRY/ TDY Cena bez DPH [EUR] (MOAIR: +12 EUR) (MOABLUE: +38 EUR)	ONE Cena bez DPH [EUR] (Nezabudovaná, v 8cm profilu v barvě radiátoru)	REG 2 Cena bez DPH [EUR]	REG 3 Cena bez DPH [EUR]	SIM Cena bez DPH [EUR]	Terma Split třída I Cena bez DPH [EUR] (nezapomeňte si koupit regulátor KTX)	Smart Split třída I Cena bez DPH [EUR] (nezapomeňte si koupit SMARTWi-Fi regulátor VEO)	Kód produktu ... Kód konfigurace s. 388
1300	390	600	843	850	870	820	830	811	796	796	WLCAN130039...
1600	390	800	953	961	980	931	941	921	906	906	WLCAN160039...
1900	390	800	1064	1072	1091	1042	1052	1032	1017	1017	WLCAN190039...

Case Slim





 Barva je zahrnuta v ceně výběr připojení v ceně

DOPORUČUJEME PRO PŘIPOJENÍ Z1, Z8 i ZX:



Sada krycí integrovaná, Chrom

TGPCR002: 38 EUR

Stránka: 374



Držák CASE Slim

cena 1 Euro - při objednání spolu s radiátorem.

Každý další držák navíc za standardní cenu.

Stránka: 320



Integrovaná sada termostatická, Chrom

WRZT5G1-CR: 145 EUR

WRZT5G2-CR: 145 EUR

Stránka: 332



RADIÁTOR VODNÍ / VODNĚ-ELEKTRICKÝ (DOKOUPIT TOPNOU TYČ)

Připojení:

Výška [mm] 585÷1810:



Výška [mm] 585:



Výška [mm]

1360÷1810:

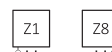

RADIÁTOR SE SKLÁDÁ ZE 2 ČÁSTÍ

1. ČÁST - VÝMĚNÍK RADIÁTORU

A ↓ [mm]	B ↔ [mm]	75/65/20°C [W]	55/45/20°C [W]	 [W]	Barvy RAL a speciální barvy Cena bez DPH [EUR]	Kód produktu ... Kód konfigurace s.385 výměník skladem vždy RAL 9016, volíte si barvu montážních úchytů, RAL 9016 skladem
585	900	438	229	–	374	WGCSX058090 K...
585	1100	536	281	–	389	WGCSX058110 K...
585	1300	634	332	–	449	WGCSX058130 K...
1360	420	422	219	400	315	WGCSX136042 K...
1360	520	523	271	600	342	WGCSX136052 K...
1360	620	624	324	600	372	WGCSX136062 K...
1585	420	470	243	400	344	WGCSX158042 K...
1585	520	580	300	600	380	WGCSX158052 K...
1585	620	693	358	800	409	WGCSX158062 K...
1810	420	516	266	600	374	WGCSX181042 K...
1810	520	639	330	600	408	WGCSX181052 K...
1810	620	762	393	800	448	WGCSX181062 K...

2. ČÁST – OPLÁŠTĚNÍ VÝMĚNÍKU

A ⇕ (mm)	B ↔ (mm)	KOV		SKLO v barvách RAL		ZRCADLO		POTISK SKLA dle přání	
		Barvy RAL a speciální barvy Cena bez DPH [EUR]	Kód produktu ... Kód konfigurace s. 391	Barvy RAL Cena bez DPH [EUR]	Kód produktu ... Kód konfigurace s. 391	Barvy RAL a speciální barvy Cena bez DPH [EUR]	Kód produktu ... Kód konfigurace s. 391	Barvy RAL a speciální barvy Cena bez DPH [EUR]	Kód produktu ... Kód konfigurace s. 391
585	900	304	WRBCSS058090...	466	WRBCSG058090...	375	WRBCSM058090...	469	WRBCSP058090...
585	1100	369	WRBCSS058110...	563	WRBCSG058110...	451	WRBCSM058110...	567	WRBCSP058110...
585	1300	394	WRBCSS058130...	621	WRBCSG058130...	489	WRBCSM058130...	625	WRBCSP058130...
1360	420	298	WRBCSS136042...	472	WRBCSG136042...	373	WRBCSM136042...	475	WRBCSP136042...
1360	520	324	WRBCSS136052...	537	WRBCSG136052...	414	WRBCSM136052...	540	WRBCSP136052...
1360	620	353	WRBCSS136062...	604	WRBCSG136062...	457	WRBCSM136062...	608	WRBCSP136062...
1585	420	316	WRBCSS158042...	517	WRBCSG158042...	401	WRBCSM158042...	520	WRBCSP158042...
1585	520	348	WRBCSS158052...	593	WRBCSG158052...	450	WRBCSM158052...	597	WRBCSP158052...
1585	620	375	WRBCSS158062...	664	WRBCSG158062...	493	WRBCSM158062...	670	WRBCSP158062...
1810	420	336	WRBCSS181042...	563	WRBCSG181042...	431	WRBCSM181042...	567	WRBCSP181042...
1810	520	365	WRBCSS181052...	643	WRBCSG181052...	480	WRBCSM181052...	648	WRBCSP181052...
1810	620	400	WRBCSS181062...	728	WRBCSG181062...	533	WRBCSM181062...	734	WRBCSP181062...

Cena se počítá jako pro Ventily a příslušenství

VÝBĚR Z POTISKŮ SKEL NA OPLÁŠTĚNÍ CASE SLIM:

CASE SLIM na výšku:



CASE SLIM horizontální:



Parametry vlastního potisku:

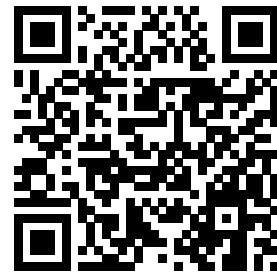

Case Slim E



Barva je zahrnuta v ceně



výběr připojení v ceně

RADIÁTOR ELEKTRICKÝ (CENA VČETNĚ NÁPLNĚ A ZVOLENÉ TOPNÉ TYČE)

Připojení:



RADIÁTOR SE SKLÁDÁ ZE 2 ČÁSTÍ

1. ČÁST - VÝMĚNÍK RADIÁTORU

A ↕ [mm]	B ↔ [mm]	Výkon [W]	MEG Cena bez DPH [EUR]	MOA/DRY/ TDY Cena bez DPH [EUR] (MOA IR: +12 EUR) (MOA BLUE: +38 EUR)	ONE Cena bez DPH [EUR] (Nezabudovaná, v 8cm profilu v barvě radiátoru)	REG 2 Cena bez DPH [EUR]	REG 3 Cena bez DPH [EUR]	SIM Cena bez DPH [EUR]	Terma Split třída I Cena bez DPH [EUR] (nezapomeňte si koupit regulátor KTX)	Smart Split třída I Cena bez DPH [EUR] (nezapomeňte si koupit SMARTWi-Fi regulátor VEO)	Kód produktu ... Kód konfigurace s. 388 výměník skládem vždy RAL 9016, volte si barvu montážních úchyťů, RAL 9016 skládem
585	900	-	-	-	-	-	-	-	-	-	WLCSX058090 K...
585	1100	-	-	-	-	-	-	-	-	-	WLCSX058110 K...
585	1300	-	-	-	-	-	-	-	-	-	WLCSX058130 K...
1360	420	400	456	463	483	434	444	424	409	409	WLCSX136042 K...
1360	520	600	487	494	514	465	475	455	440	440	WLCSX136052 K...
1360	620	600	522	529	549	500	510	490	475	475	WLCSX136062 K...
1585	420	400	489	497	516	467	477	457	443	443	WLCSX158042 K...
1585	520	600	531	538	558	509	519	499	484	484	WLCSX158052 K...
1585	620	800	565	573	592	543	553	533	519	519	WLCSX158062 K...
1810	420	600	524	532	551	502	512	492	478	478	WLCSX181042 K...
1810	520	600	565	572	592	542	552	533	518	518	WLCSX181052 K...
1810	620	800	611	618	638	589	598	579	564	564	WLCSX181062 K...

2. ČÁST – OPLÁŠTĚNÍ VÝMĚNÍKU

A ⇕ (mm)	B ↔ (mm)	KOV		SKLO v barvách RAL		ZRCADLO		POTISK SKLA dle přání	
		Barvy RAL a speciální barvy Cena bez DPH [EUR]	Kód produktu ... Kód konfigurace s. 391	Barvy RAL Cena bez DPH [EUR]	Kód produktu ... Kód konfigurace s. 391	Barvy RAL a speciální barvy Cena bez DPH [EUR]	Kód produktu ... Kód konfigurace s. 391	Barvy RAL a speciální barvy Cena bez DPH [EUR]	Kód produktu ... Kód konfigurace s. 391
585	900	304	WRBCSS058090...	466	WRBCSG058090...	375	WRBCSM058090...	469	WRBCSP058090...
585	1100	369	WRBCSS058110...	563	WRBCSG058110...	451	WRBCSM058110...	567	WRBCSP058110...
585	1300	394	WRBCSS058130...	621	WRBCSG058130...	489	WRBCSM058130...	625	WRBCSP058130...
1360	420	298	WRBCSS136042...	472	WRBCSG136042...	373	WRBCSM136042...	475	WRBCSP136042...
1360	520	324	WRBCSS136052...	537	WRBCSG136052...	414	WRBCSM136052...	540	WRBCSP136052...
1360	620	353	WRBCSS136062...	604	WRBCSG136062...	457	WRBCSM136062...	608	WRBCSP136062...
1585	420	316	WRBCSS158042...	517	WRBCSG158042...	401	WRBCSM158042...	520	WRBCSP158042...
1585	520	348	WRBCSS158052...	593	WRBCSG158052...	450	WRBCSM158052...	597	WRBCSP158052...
1585	620	375	WRBCSS158062...	664	WRBCSG158062...	493	WRBCSM158062...	670	WRBCSP158062...
1810	420	336	WRBCSS181042...	563	WRBCSG181042...	431	WRBCSM181042...	567	WRBCSP181042...
1810	520	365	WRBCSS181052...	643	WRBCSG181052...	480	WRBCSM181052...	648	WRBCSP181052...
1810	620	400	WRBCSS181062...	728	WRBCSG181062...	533	WRBCSM181062...	734	WRBCSP181062...

Cena se počítá jako pro Ventily a příslušenství

VÝBĚR Z POTISKŮ SKEL NA OPLÁŠTĚNÍ CASE SLIM:

CASE SLIM na výšku:



CASE SLIM horizontální:



Parametry vlastního potisku:

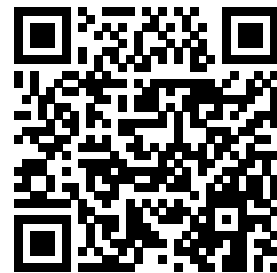



Barva je zahrnuta v ceně

výběr připojení v ceně

DOPORUČUJEME PRO PŘIPOJENÍ ZX, Z1 i Z8:



Integrovaná sada termostatická, Chrom

WRZT5G1-CR: 145 EUR

WRZT5G2-CR: 145 EUR

Stránka: 332



Sada krycí integrovaná, Chrom

TGPCR002: 38 EUR

Stránka: 374



Topná tyč KTX4 BLUE, Chrom

WEK4B*: 161 EUR

Stránka: 288



RADIÁTOR VODNÍ / VODNĚ-ELEKTRICKÝ (DOKOUPIT TOPNOU TYČ)

Připojení:

Výška [mm] 510÷1860:

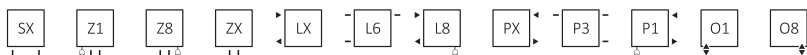

Výška [mm] 780-1860:

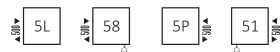

A ↕ [mm]	B ↔ [mm]	75/65/20°C [W]	55/45/20°C [W]	 [W]	Barvy RAL a speciální barvy Cena bez DPH [EUR]	Kód produktu ... Kód konfigurace s. 385
510	500	304	164	300	285	WGCIT051050...
510	600	362	195	400	295	WGCIT051060...
780	500	455	245	400	318	WGCIT078050...
780	600	541	291	600	334	WGCIT078060...
1050	500	600	323	600	349	WGCIT105050...
1050	600	714	384	800	368	WGCIT105060...
1320	500	739	397	800	382	WGCIT132050...
1320	600	879	473	800	402	WGCIT132060...
1590	500	887	476	800	414	WGCIT159050...
1590	600	1055	566	1000	439	WGCIT159060...
1860	500	1032	553	1000	448	WGCIT186050...
1860	600	1227	657	1200	483	WGCIT186060...

City E



Barva je zahrnuta v ceně



výběr připojení v ceně

RADIÁTOR ELEKTRICKÝ (CENA VČETNĚ NÁPLNĚ A ZVOLENÉ TOPNÉ TYČE)

Připojení:

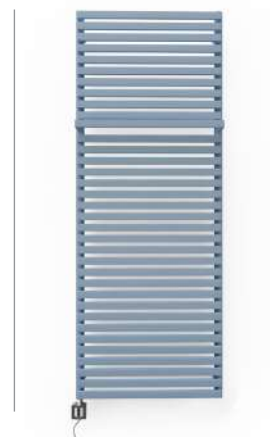

A ↕ [mm]	B ↔ [mm]	Výkon [W]	MEG Cena bez DPH [EUR]	MOA/DRY/ TDY Cena bez DPH [EUR] (MOAIR: +12 EUR) (MOABLUE: +38 EUR)	ONE Cena bez DPH [EUR] (Nezabudovaná, v 8cm profilu v barvě radiátoru)	REG 2 Cena bez DPH [EUR]	REG 3 Cena bez DPH [EUR]	SIM Cena bez DPH [EUR]	Terma Split třída I Cena bez DPH [EUR] (nezapomeňte si koupit regulátor KTX)	Smart Split třída I Cena bez DPH [EUR] (nezapomeňte si koupit SMART Wi-Fi regulátor VEO)	Kód produktu ... Kód konfigurace s. 388
510	500	300	380	387	407	357	367	348	333	333	WLCIT051050...
510	600	400	389	397	416	367	377	357	343	343	WLCIT051060...
780	500	400	413	420	440	391	400	381	366	366	WLCIT078050...
780	600	600	429	436	456	407	416	397	382	382	WLCIT078060...
1050	500	600	443	451	471	421	431	412	397	397	WLCIT105050...
1050	600	800	463	471	490	441	451	431	416	416	WLCIT105060...
1320	500	800	477	484	504	455	464	445	430	430	WLCIT132050...
1320	600	800	496	504	523	474	484	464	450	450	WLCIT132060...
1590	500	800	509	516	536	487	496	477	462	462	WLCIT159050...
1590	600	1000	533	541	560	511	521	501	487	487	WLCIT159060...
1860	500	1000	543	550	570	521	531	511	496	496	WLCIT186050...
1860	600	1200	576	584	603	554	564	544	530	530	WLCIT186060...

City One



Barva je zahrnuta v ceně



výběr připojení v ceně



TŘÍDA I



IPx5



2h/1



SADA OBSAHUJE:

Radiátor se zabudovanou topnou tyčí One. Funkce topné tyče ONE: Stránka 287.

DOPORUČUJEME PRO PŘIPOJENÍ S1 i S8:



Integrovaná sada termostatická s ponornou trubicí, Chrom

WRZT5G5-CR: 151EUR

WRZT5G6-CR: 151EUR

Stránka: 334



Sada krycí integrovaná, Chrom

TGPCR002: 38EUR

Stránka: 374



Regulátor TTIR1

TGRTBI001: 104EUR

Stránka: 304



RADIÁTOR VODNĚ-ELEKTRICKÝ (CENA VČETNĚ ZABUDOVANÉ TOPNÉ TYČE ONE)

Připojení:

Vyber druh kabelu:

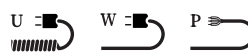
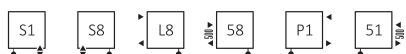

A ↕ [mm]	B ↔ [mm]	75/65/20°C [W]	55/45/20°C [W]	[W]	Barvy RAL a speciální barvy Cena bez DPH [EUR]	Kód produktu ... Kód konfigurace s. 386
780	500	455	245	400	415	WZCIN078050...
780	600	541	291	600	431	WZCIN078060...
1050	500	600	323	600	446	WZCIN105050...
1050	600	714	384	800	466	WZCIN105060...
1320	500	739	397	800	479	WZCIN132050...
1320	600	879	473	800	499	WZCIN132060...
1590	500	887	476	800	511	WZCIN159050...
1590	600	1055	566	1000	536	WZCIN159060...
1860	500	1032	553	1000	546	WZCIN186050...

City One E



Barva je zahrnuta v ceně



výběr připojení v ceně



TŘÍDA I



45-60°C/2



P-W-U



120-1000W



IR



IPx5



2h/1



RADIÁTOR ELEKTRICKÝ (CENA VČETNĚ NÁPLNĚ A ZABUDOVANÉ TOPNÉ TYČE ONE)

Připojení:

E1

E8



A ↕ [mm]	B ↔ [mm]	Výkon [W]	Cena bez DPH [EUR]	Kód produktu <small>... Kód konfigurace s. 387</small>
780	500	400	434	WWCIN078050...
780	600	600	450	WWCIN078060...
1050	500	600	464	WWCIN105050...
1050	600	800	484	WWCIN105060...
1320	500	800	498	WWCIN132050...
1320	600	800	517	WWCIN132060...
1590	500	800	530	WWCIN159050...
1590	600	1000	554	WWCIN159060...
1860	500	1000	564	WWCIN186050...

Cyklon V



Barva je zahrnuta v ceně



výběr připojení v ceně

DOPORUČUJEME PRO PŘIPOJENÍ YL i YP:



Integrovaná sada termostatická,
Chrom

WRZT5G1-CR: 145 EUR

WRZT5G2-CR: 145 EUR

Stránka: 332



Sada krycí integrovaná, Chrom
TGPCR002: 38 EUR

Stránka: 374



Háček bodový KUKA 70,
Chrom

WRWKUK002 KCRO: 44 EUR

Stránka: 315



RADIÁTOR VODNÍ:

Připojení:



A ↕ [mm]	B ↔ [mm]	75/65/20°C [W]	55/45/20°C [W]	Barvy RAL a speciální barvy Cena bez DPH [EUR]	Kód produktu ... Kód konfigurace s. 385
1600	410	704	375	857	WGCW160041...
1600	495	845	451	924	WGCW160049...
1900	410	832	439	936	WGCW190041...
1900	495	999	528	1 003	WGCW190049...
1900	580	1166	616	1 081	WGCW190058...

Cyklon H



Barva je zahrnuta v ceně



výběr připojení v ceně

DOPORUČUJEME PRO PŘIPOJENÍ O1 i O8:



Integrovaná sada termostatická s ponornou trubicí, Chrom



WRZT5G5-CR: 151 EUR



WRZT5G6-CR: 151 EUR

Stránka: 334



Sada krycí integrovaná, Chrom

TGPCR002: 38 EUR

Stránka: 374



Háček bodový KUKA 70, Chrom

WRWKUK002 KCRO: 44 EUR

Stránka: 315



RADIÁTOR VODNÍ:

Připojení:



A ↕ [mm]	B ↔ [mm]	75/65/20°C [W]	55/45/20°C [W]	Barvy RAL a speciální barvy Cena bez DPH [EUR]	Kód produktu ... Kód konfigurace s. 385
410	1000	408	212	737	WGCYH041100...
410	1300	497	255	790	WGCYH041130...
410	1600	587	298	842	WGCYH041160...
495	1000	490	249	779	WGCYH049100...
495	1300	597	299	853	WGCYH049130...
495	1600	704	349	910	WGCYH049160...
580	1300	697	342	910	WGCYH058130...
580	1600	821	399	1 003	WGCYH058160...

Crystal





 Barva je zahrnuta v ceně výběr připojení v ceně

DOPORUČUJEME PRO PŘIPOJENÍ ZX, Z1 i Z8:



Integrovaná sada termostatická, Chrom

 WRZT5G1-CR: 145 EUR

 WRZT5G2-CR: 145 EUR

Stránka: 332



Sada krycí integrovaná, Chrom

TGPCR002: 38 EUR

Stránka: 374



Háček bodový ZIP H 20, Chrom

WRWZIP010 KCRO: 42 EUR

Stránka: 316



Topná tyč ONE, Chrom

WEOPX*: 127 EUR

Stránka: 286



RADIÁTOR VODNÍ / VODNĚ-ELEKTRICKÝ (DOKOUPIT TOPNOU TYČ)

Připojení:

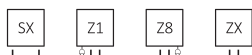

A ↕ [mm]	B ↔ [mm]	75/65/20°C [W]	55/45/20°C [W]	Barvy RAL a speciální barvy Cena bez DPH [EUR]	Kód produktu ... Kód konfigurace s. 385
480	400	135	73	201	WGCR2048040...
480	500	158	86	205	WGCR2048050...
480	600	181	98	209	WGCR2048060...
840	400	236	128	281	WGCR2084040...
840	500	276	149	287	WGCR2084050...
840	600	316	171	295	WGCR2084060...
1200	400	342	185	332	WGCR2120040...
1200	500	400	216	338	WGCR2120050...
1200	600	458	247	346	WGCR2120060...
1560	400	445	239	380	WGCR2156040...
1560	500	521	279	390	WGCR2156050...
1560	600	595	319	400	WGCR2156060...
1920	400	548	294	431	WGCR2192040...
1920	500	641	344	441	WGCR2192050...
1920	600	732	393	451	WGCR2192060...

Crystal E



Barva je zahrnuta v ceně



výběr připojení v ceně

RADIÁTOR ELEKTRICKÝ (CENA VČETNĚ NÁPLNĚ A ZVOLENÉ TOPNÉ TYČE)

Připojení:



A ↕ [mm]	B ↔ [mm]	Výkon [W]	MEG Cena bez DPH [EUR]	MOA/DRY/ TDY Cena bez DPH [EUR] (MOA IR: +12 EUR) (MOA BLUE: +38 EUR)	ONE Cena bez DPH [EUR] (Nezabudovaná, v 8cm profilu v barvě radiátoru)	REG 2 Cena bez DPH [EUR]	REG 3 Cena bez DPH [EUR]	SIM Cena bez DPH [EUR]	Terma Split třída I Cena bez DPH [EUR] (nezapomeňte si koupit regulátor KTX)	Smart Split třída I Cena bez DPH [EUR] (nezapomeňte si koupit SMART Wi-Fi regulátor VEO)	Kód produktu ... Kód konfigurace s. 388
480	400	100	296	303	347	274	283	263	248	248	WLCR2048040...
480	500	100	301	308	352	279	288	268	253	253	WLCR2048050...
480	600	200	305	312	356	283	292	273	258	258	WLCR2048060...
840	400	200	389	396	440	367	376	356	341	341	WLCR2084040...
840	500	300	396	403	447	374	383	363	348	348	WLCR2084050...
840	600	300	405	412	456	383	392	372	357	357	WLCR2084060...
1200	400	400	448	455	499	426	435	415	400	400	WLCR2120040
1200	500	400	455	462	506	433	442	422	407	407	WLCR2120050...
1200	600	400	464	471	515	442	451	432	417	417	WLCR2120060...
1560	400	400	504	511	555	482	491	471	456	456	WLCR2156040...
1560	500	600	515	522	566	493	502	483	468	468	WLCR2156050...
1560	600	600	527	534	578	505	514	494	479	479	WLCR2156060...
1920	400	600	563	570	614	541	550	530	515	515	WLCR2192040...
1920	500	600	574	581	625	552	562	542	527	527	WLCR2192050...
1920	600	800	586	593	637	564	573	553	538	538	WLCR2192060...

DOPORUČUJEME PRO PŘIPOJENÍ V2, V7, VP i VL:



Integrovaná sada uzavírací,

Chrom

WRZOSSC1-CR: 116 EUR

Stránka: 335



Sada krycí integrovaná,

Chrom

TGPCR002: 38 EUR

Stránka: 374



Topná tyč MOA, Chrom

WEMOA*: 105 EUR

Stránka: 295



RADIÁTOR VODNÍ / VODNĚ-ELEKTRICKÝ (DOKOUPIT TOPNOU TYČ)

Připojení:

Výška [mm] 440÷1800

Výška [mm] 440÷640

Výška [mm] 1800÷2000

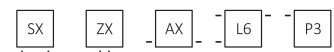
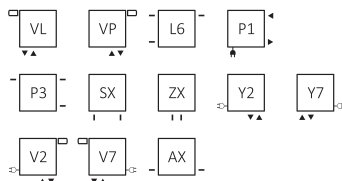

A ↕ [mm]	B ↔ [mm]	75/65/20°C [W]	55/45/20°C [W]	 [W]	Barvy RAL a speciální barvy Cena bez DPH [EUR]	Kód produktu ... Kód konfigurace s. 385
440	820	705	370	800	319	WGDLF044082...
440	1020	885	465	800	345	WGDLF044102...
440	1220	1061	556	1000	376	WGDLF044122...
540	820	846	442	800	325	WGDLF054082...
540	1020	1057	552	1000	361	WGDLF054102...
540	1220	1264	661	1200	427	WGDLF054122...
640	820	986	514	1000	383	WGDLF064082...
640	1020	1233	644	1200	427	WGDLF064102...
640	1220	1458	760	1500	472	WGDLF064122...
1800	500	1403	717	-	582	WGDLF180050...
1800	580	1623	830	-	655	WGDLF180058...
2000	500	1556	802	-	640	WGDLF200050...
2000	580	1774	909	-	726	WGDLF200058...

Delfin E



Barva je zahrnuta v ceně



výběr připojení v ceně

RADIÁTOR ELEKTRICKÝ (CENA VČETNĚ NÁPLNĚ A ZVOLENÉ TOPNÉ TYČE)

Připojení:

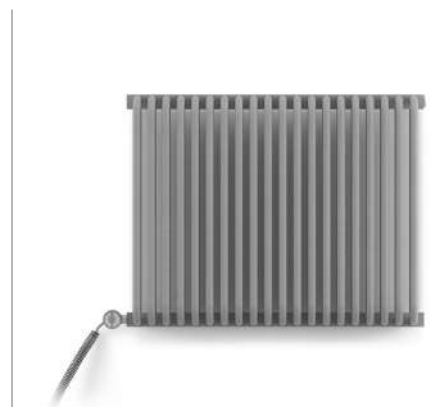

A ↕ [mm]	B ↔ [mm]	Výkon [W]	MEG Cena bez DPH [EUR]	MOA/DRY/ TDY Cena bez DPH [EUR] (MOA IR: +12 EUR) (MOA BLUE: +38 EUR)	ONE Cena bez DPH [EUR] (Nezabudovaná, v 8cm profilu v barvě radiátoru)	REG 2 Cena bez DPH [EUR]	REG 3 Cena bez DPH [EUR]	SIM Cena bez DPH [EUR]	Terma Split třída I Cena bez DPH [EUR] (nezapomeňte si koupit regulátor KTX)	Smart Split třída I Cena bez DPH [EUR] (nezapomeňte si koupit SMARTWi-Fi regulátor VEO)	Kód produktu ... Kód konfigurace s. 388
440	820	800	414	421	441	392	402	382	367	367	WLDLF044082...
440	1020	800	440	447	467	418	427	408	393	393	WLDLF044102...
440	1220	1000	471	478	498	448	458	439	424	424	WLDLF044122...
540	820	800	420	427	447	398	408	388	373	373	WLDLF054082...
540	1020	1000	456	463	483	434	443	424	409	409	WLDLF054102...
540	1220	1200	522	530	549	500	510	490	–	475	WLDLF054122...
640	820	1000	478	485	505	456	466	446	431	431	WLDLF064082...
640	1020	1200	522	530	–	500	510	490	–	475	WLDLF064102...
640	1220	1500	–	–	–	–	–	534	–	519	WLDLF064122...

Dexter



Barva je zahrnutá v ceně

výběr připojení v ceně

DOPORUČUJEME PRO PŘIPOJENÍ SX:



Sada Dexter regulační, chrom

TGERCD1-CR: 131 EUR

TGERCD2-CR: 131 EUR

Stránka: 323



Sada Dexter termostatická, chrom

TGETCG6-CR: 174 EUR

TGETCG7-CR: 174 EUR

Stránka: 324



Sada krycí dvojité, Chrom

TGPCR001: 27 EUR

Stránka: 373



RADIÁTOR VODNÍ / VODNĚ-ELEKTRICKÝ (DOKOUPIT TOPNOU TYČ)

Připojení:



A ↕ [mm]	B ↔ [mm]	Barva ze vzorníku RAL a speciálních barev			Galvanický povrch Chrom			Barvy RAL a speciální barvy Cena bez DPH [EUR]	Chrom Cena bez DPH [EUR]	Kód produktu ... Kód konfigurace s. 385
		75/65/20°C [W]	55/45/20°C [W]	[W]	75/65/20°C [W]	55/45/20°C [W]	[W]			
860	400	323	174	300	225	117	200	264	479	WGDEX086040...
860	500	394	212	400	281	147	300	271	502	WGDEX086050...
860	600	464	250	400	337	176	400	281	537	WGDEX086060...
1220	400	440	237	400	298	155	300	307	641	WGDEX122040...
1220	500	541	291	600	373	194	400	318	665	WGDEX122050...
1220	600	640	344	600	448	233	400	334	710	WGDEX122060...
1760	400	618	332	600	–	–	–	404	–	WGDEX176040...
1760	500	762	409	800	–	–	–	420	–	WGDEX176050...
1760	600	906	487	1000	–	–	–	440	–	WGDEX176060...

Dexter E



Barva je zahrnuta v ceně



výběr připojení v ceně

RADIÁTOR ELEKTRICKÝ (CENA VČETNĚ NÁPLNĚ A ZVOLENÉ TOPNÉ TYČE)

Připojení:



A ↓ [mm]	B ↔ [mm]	Výkon [W]	MEG Cena bez DPH [EUR]		MOA/DRY/TDY Cena bez DPH [EUR] (MOA IR: +12 EUR) (MOA BLUE: +38 EUR)		ONE Cena bez DPH [EUR] (Nezabudovaná, v 8cm profilu v barvě radiátoru)		REG 2 Cena bez DPH [EUR]		REG 3 Cena bez DPH [EUR]		SIM Cena bez DPH [EUR]		Terma Split třída I Cena bez DPH [EUR] (nezapomeňte si koupit regulátor KTX)		Smart Split třída I Cena bez DPH [EUR] (nezapomeňte si koupit SMART Wi-Fi regulátor VEO)		Kód produktu ... Kód konfigurace s. 388	
			Barva Chrom	Barvy RAL a speciální barvy Chrom	Barvy RAL a speciální barvy Chrom	Barvy RAL a speciální barvy Chrom	Barvy RAL a speciální barvy Chrom	Barvy RAL a speciální barvy Chrom	Barvy RAL a speciální barvy Chrom	Barvy RAL a speciální barvy Chrom	Barvy RAL a speciální barvy Chrom	Barvy RAL a speciální barvy Chrom	Barvy RAL a speciální barvy Chrom	Barvy RAL a speciální barvy Chrom	Barvy RAL a speciální barvy Chrom	Barvy RAL a speciální barvy Chrom	Barvy RAL a speciální barvy Chrom			
860	400	400	200	359	574	366	581	386	601	336	552	346	562	327	542	312	527	312	527	WLDEX086040...
860	500	400	300	366	597	373	605	393	624	344	575	354	585	334	565	319	550	319	550	WLDEX086050...
860	600	600	400	376	632	383	639	403	659	354	609	364	619	344	600	329	585	329	585	WLDEX086060...
1220	400	400	300	402	736	409	743	429	763	380	714	389	724	370	704	355	689	355	689	WLDEX122040...
1220	500	600	400	413	759	420	767	440	787	391	737	400	747	381	728	366	713	366	713	WLDEX122050...
1220	600	800	400	429	805	436	812	456	832	407	783	416	793	397	773	382	758	382	758	WLDEX122060...
1760	400	600	-	499	-	506	-	526	-	477	-	487	-	467	-	452	-	452	-	WLDEX176040...
1760	500	800	-	515	-	522	-	542	-	493	-	502	-	483	-	468	-	468	-	WLDEX176050...
1760	600	1000	-	534	-	542	-	562	-	512	-	522	-	502	-	488	-	488	-	WLDEX176060...

Dexter One



Barva je zahrnuta v ceně



výběr připojení v ceně



TŘÍDA I



45-60°C/2



P-W-U



120-1000W



IR



SADA OBSAHUJE:

Radiátor se zabudovanou topnou tyčí One. Funkce topné tyče ONE: Stránka 287.

DOPORUČUJEME PRO PŘIPOJENÍ S1 i S8:



Integrovaná sada termostatická s ponornou trubicí, Chrom

WRZT5G5-CR: 151EUR

WRZT5G6-CR: 151EUR

Stránka: 334



Sada krycí integrovaná, Chrom

TGPCR002: 38EUR

Stránka: 374



Regulátor TTIR1

TGRTBI001: 104EUR

Stránka: 304



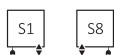

RADIÁTOR VODNĚ-ELEKTRICKÝ (CENA VČETNĚ ZABUDOVANÉ TOPNÉ TYČE ONE)

Připojení:

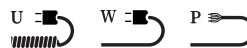

Vyber druh kabelu:



A ↕ [mm]	B ↔ [mm]	Barva ze vzorníku RAL a speciálních barev			Galvanický povrch Chrom			Barvy RAL a speciální barvy Cena bez DPH [EUR]	Chrom Cena bez DPH [EUR]	Kód produktu ... Kód konfigurace s. 386
		75/65/20°C [W]	55/45/20°C [W]	 [W]	75/65/20°C [W]	55/45/20°C [W]	 [W]			
860	400	323	174	300	225	117	200	361	576	WZDEN086040...
860	500	394	212	400	281	147	300	368	600	WZDEN086050...
860	600	464	250	400	337	176	400	378	634	WZDEN086060...
1220	400	440	237	400	298	155	300	404	739	WZDEN122040...
1220	500	541	291	600	373	194	400	415	762	WZDEN122050...
1220	600	640	344	600	448	233	400	431	807	WZDEN122060...
1760	400	618	332	600	-	-	-	501	-	WZDEN176040...
1760	500	762	409	800	-	-	-	517	-	WZDEN176050...
1760	600	906	487	1000	-	-	-	537	-	WZDEN176060...

Dexter One E



Barva je zahrnuta v ceně

výběr připojení v ceně



RADIÁTOR ELEKTRICKÝ (CENA VČETNĚ NÁPLNĚ A ZABUDOVANÉ TOPNÉ TYČE ONE)

Připojení:



A ↕ [mm]	B ↔ [mm]	Výkon [W]		Barvy RAL a speciální barvy Cena bez DPH [EUR]	Chrom Cena bez DPH [EUR]	Kód produktu ... Kód konfigurace s.387
		Barva	Chrom			
860	400	400	200	380	595	WWDEN086040...
860	500	400	300	387	618	WWDEN086050...
860	600	600	400	397	653	WWDEN086060...
1220	400	400	300	423	757	WWDEN122040...
1220	500	600	400	434	780	WWDEN122050...
1220	600	800	400	450	826	WWDEN122060...
1760	400	600	–	520	–	WWDEN176040...
1760	500	800	–	536	–	WWDEN176050...
1760	600	1000	–	555	–	WWDEN176060...

Diamond



DOPORUČUJEME PRO PŘIPOJENÍ SX:



Sada tříosová termostatická, Chrom

WRZTCG1-CR: 143EUR

WRZTCG2-CR: 143EUR

Stránka: 330



Sada krycí dvojitá, Chrom

TGPCR001: 27EUR

Stránka: 373



Spark 1 Spark 2 Spark 3

Háček bodový SPARK

SPARK 1 - WRWSP1025 KCRO: 46 EUR

SPARK 2 - WRWSP2025 KCRO: 46 EUR

SPARK 3 - WRWSP3025 KCRO: 46 EUR

Stránka: 315



RADIÁTOR VODNÍ / VODNĚ-ELEKTRICKÝ (DOKOUPIT TOPNOU TYČ)

Připojení:

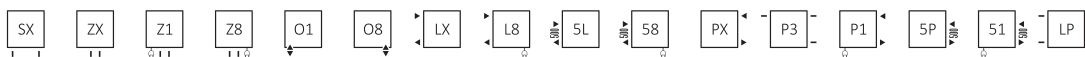

A ⇕ [mm]	B ↔ [mm]	Barva ze vzorníku RAL a speciálních barev			Galvanický povrch Chrom			Barvy RAL a speciální barvy Cena bez DPH [EUR]	Chrom Cena bez DPH [EUR]	Kód produktu ... Kód konfigurace s. 385
		75/65/20°C [W]	55/45/20°C [W]	[W]	75/65/20°C [W]	55/45/20°C [W]	[W]			
880	400	270	146	300	189	102	200	325	654	WGDIM088040...
880	500	320	174	300	224	122	200	332	676	WGDIM088050...
880	600	367	199	400	257	139	300	338	703	WGDIM088060...
1120	400	340	184	400	238	129	200	372	730	WGDIM112040...
1120	500	400	217	400	280	152	300	380	762	WGDIM112050...
1120	600	461	249	400	323	174	300	388	795	WGDIM112060...
1360	400	410	221	400	287	155	300	418	810	WGDIM136040...
1360	500	484	261	600	339	183	400	426	848	WGDIM136050...
1360	600	554	299	600	388	209	400	437	885	WGDIM136060...
1600	400	480	259	400	336	181	400	461	889	WGDIM160040...
1600	500	563	304	600	394	213	400	471	930	WGDIM160050...
1600	600	647	349	600	453	244	400	484	976	WGDIM160060...

Diamond E



Barva je zahrnuta v ceně



výběr připojení v ceně

RADIÁTOR ELEKTRICKÝ (CENA VČETNĚ NÁPLNĚ A ZVOLENÉ TOPNÉ TYČE)

Připojení:



A ↕ [mm]	B ↔ [mm]	Výkon [W]		MEG		MOA/DRY/TDY		ONE		REG 2		REG 3		SIM		Terma Split třída I		Smart Split třída I		Kód produktu ... Kód konfigurace s.388
				Cena bez DPH [EUR]		Cena bez DPH [EUR] (MOAIR: +12 EUR) (MOABLUE: +38 EUR)		Cena bez DPH [EUR] (Nezabudovaná, v 8cm profilu v barvě radiátoru)		Cena bez DPH [EUR]		Cena bez DPH [EUR]		Cena bez DPH [EUR]		Cena bez DPH [EUR] (nezapomeňte si koupit regulátor KTX)		Cena bez DPH [EUR] (nezapomeňte si koupit SMARTWi-Fi regulátor VEO)		
		Barna	Chrom	BaryRAL a speciální barvy	Chrom	BaryRAL a speciální barvy	Chrom	BaryRAL a speciální barvy	Chrom	BaryRAL a speciální barvy	Chrom	BaryRAL a speciální barvy	Chrom	BaryRAL a speciální barvy	Chrom	BaryRAL a speciální barvy	Chrom	BaryRAL a speciální barvy	Chrom	
880	400	300	200	420	748	427	756	447	775	398	726	408	736	388	716	373	702	373	702	WLDIM088040...
880	500	300	200	426	771	434	778	453	798	404	748	414	758	394	739	380	724	380	724	WLDIM088050...
880	600	400	300	432	798	440	805	459	825	410	775	420	785	400	766	386	751	386	751	WLDIM088060...
1120	400	400	200	467	825	474	832	494	852	445	803	455	812	435	793	420	778	420	778	WLDIM112040...
1120	500	400	300	474	857	482	864	501	884	452	834	462	844	442	825	427	810	427	810	WLDIM112050...
1120	600	400	300	483	890	490	897	510	917	461	868	471	878	451	858	436	843	436	843	WLDIM112060...
1360	400	400	300	512	905	520	912	539	932	490	882	500	892	480	873	466	858	466	858	WLDIM136040...
1360	500	600	400	521	943	528	950	548	970	499	921	509	930	489	911	474	896	474	896	WLDIM136050...
1360	600	600	400	532	980	539	987	559	1 007	510	957	520	967	500	948	485	933	485	933	WLDIM136060...
1600	400	400	400	557	983	564	991	584	1 010	534	961	544	971	525	951	510	937	510	937	WLDIM160040...
1600	500	600	400	565	1 025	573	1 032	592	1 052	543	1 003	553	1 013	533	993	518	978	518	978	WLDIM160050...
1600	600	600	400	577	1 072	585	1 079	605	1 099	555	1 050	565	1 060	546	1 040	531	1 025	531	1 025	WLDIM160060...



výběr připojení v ceně

DOPORUČUJEME PRO PŘIPOJENÍ SX:



Sada tříosová termostatická s možností montáže topné tyče skrz ventil, Chrom

WRZTCG4-CR: 147 EUR

WRZTCG5-CR: 147 EUR

Stránka: 331



Sada krycí dvojité, Chrom
TGPCR001: 27 EUR

Stránka: 373



Topná tyč REG 3, Bílá
WER3G02*: 78 EUR

Stránka: 299



Háček bodový YO!
WRWYOY001*: 4 EUR

Stránka: 316



RADIÁTOR VODNÍ / VODNĚ-ELEKTRICKÝ (DOKOUPIT TOPNOU TYČ)

Připojení:



A ↕ [mm]	B ↔ [mm]	Barva ze vzorníku RAL a speciálních barev			Galvanický povrch Chrom			Barvy RAL a speciální barvy Cena bez DPH [EUR]	Chrom Cena bez DPH [EUR]	Kód produktu ... Kód konfigurace s. 385
		75/65/20°C [W]	55/45/20°C [W]	[W]	75/65/20°C [W]	55/45/20°C [W]	[W]			
786	400	296	161	300	207	106	200	189	364	WGDOM078040...
786	500	369	199	400	258	132	300	196	394	WGDOM078050...
786	600	435	235	400	305	155	300	209	424	WGDOM078060...
1116	400	413	222	400	289	147	300	216	469	WGDOM111040...
1116	500	513	274	600	359	183	400	232	515	WGDOM111050...
1116	600	620	331	600	434	221	400	248	560	WGDOM111060...
1479	400	533	284	600	373	190	400	255	546	WGDOM147040...
1479	500	663	346	600	464	237	400	280	606	WGDOM147050...
1479	600	800	425	800	560	286	600	308	681	WGDOM147060...

Domi E



Barva je zahrnuta v ceně



výběr připojení v ceně

RADIÁTOR ELEKTRICKÝ (CENA VČETNĚ NÁPLNĚ A ZVOLENÉ TOPNÉ TYČE)

Připojení:

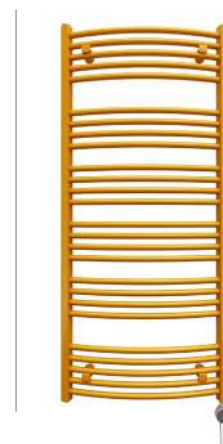

A ↓ [mm]	B ↔ [mm]	Výkon [W]		MEG Cena bez DPH [EUR]		MOA/DRY/TDY Cena bez DPH [EUR] (MOA IR: +12 EUR) (MOA BLUE: +38 EUR)		ONE Cena bez DPH [EUR] (Nezabudovaná, v 8cm profilu v barvě radiátoru)		REG 2 Cena bez DPH [EUR]		REG 3 Cena bez DPH [EUR]		SIM Cena bez DPH [EUR]		Terma Split třída I Cena bez DPH [EUR] (nezapomeňte si koupit regulátor KTX)		Smart Split třída I Cena bez DPH [EUR] (nezapomeňte si koupit SMART Wi-Fi regulátor VEO)		Kód produktu ... Kód konfigurace s. 388
				Barva	Chrom	Barvy RAL a speciální barvy	Chrom	Barvy RAL a speciální barvy	Chrom	Barvy RAL a speciální barvy	Chrom	Barvy RAL a speciální barvy	Chrom	Barvy RAL a speciální barvy	Chrom	Barvy RAL a speciální barvy	Chrom	Barvy RAL a speciální barvy	Chrom	
786	400	300	200	282	458	290	466	309	485	260	436	270	446	250	426	236	412	236	412	WLDOM078040...
786	500	400	300	291	489	298	496	318	516	269	467	279	477	259	457	244	442	244	442	WLDOM078050...
786	600	400	300	303	518	311	526	330	546	281	496	291	506	271	487	257	472	257	472	WLDOM078060...
1116	400	400	300	311	564	318	571	338	591	289	542	298	552	279	532	264	517	264	517	WLDOM111040...
1116	500	600	400	327	609	334	617	354	637	305	587	314	597	295	577	280	563	280	563	WLDOM111050...
1116	600	600	400	343	655	350	662	370	682	321	633	330	643	311	623	296	608	296	608	WLDOM111060...
1479	400	600	400	350	639	357	646	377	666	328	617	338	627	318	607	303	592	303	592	WLDOM147040...
1479	500	600	400	375	700	382	708	402	728	352	678	362	688	343	668	328	654	328	654	WLDOM147050...
1479	600	800	600	402	775	409	783	429	803	380	753	389	763	370	743	355	729	355	729	WLDOM147060...

Easy



DOPORUČUJEME PRO PŘIPOJENÍ SX:



Sada tříosová termostatická, Chrom

WRZTCG1-CR: 143EUR

WRZTCG2-CR: 143EUR

Stránka: 330



Sada krycí dvojitá, Chrom

TGPCR001: 27EUR

Stránka: 373



Police EASY - Masivní dřevo

WRPEAS020 KBUK: 41EUR

WRPEAS020 KDAB: 43EUR

WRPEAS020 KTEK: 74EUR

Stránka: 309



RADIÁTOR VODNÍ / VODNĚ-ELEKTRICKÝ (DOKOUPIT TOPNOU TYČ)

Připojení:

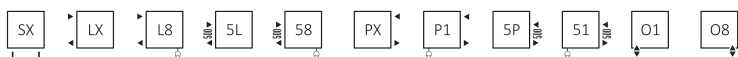

A ↓ [mm]	B ↔ [mm]	Barva ze vzorníku RAL a speciálních barev			Galvanický povrch Chrom			Barvy RAL a speciální barvy Cena bez DPH [EUR]	Chrom Cena bez DPH [EUR]	Kód produktu ... Kód konfigurace s. 385
		75/65/20°C [W]	55/45/20°C [W]	[W]	75/65/20°C [W]	55/45/20°C [W]	[W]			
640	200	124	68	120	87	44	120	232	322	WGEAS064020...
960	200	187	102	200	131	67	120	260	402	WGEAS096020...
1280	200	251	136	300	176	90	200	302	482	WGEAS128020...
1600	200	314	170	300	220	112	200	345	557	WGEAS160020...
1920	200	378	204	400	-	-	-	387	-	WGEAS192020...

Easy E



Barva je zahrnuta v ceně



výběr připojení v ceně

RADIÁTOR ELEKTRICKÝ (CENA VČETNĚ NÁPLNĚ A ZVOLENÉ TOPNÉ TYČE)

Připojení:



A ↕ [mm]	B ↔ [mm]	Výkon [W]		MEG Cena bez DPH [EUR]		MOA/DRY/TDY Cena bez DPH [EUR] (MOAIR: + 12 EUR) (MOABLUE: + 38 EUR)		ONE Cena bez DPH [EUR] (Nezabudovaná, v 8cm profilu v barvě radiátoru)		REG 2 Cena bez DPH [EUR]		REG 3 Cena bez DPH [EUR]		SIM Cena bez DPH [EUR]		Terma Split třída I Cena bez DPH [EUR] (nezapomeňte si koupit regulátor KTX)		Smart Split třída I Cena bez DPH [EUR] (nezapomeňte si koupit SMART Wi-Fi regulátor VEO)		Kód produktu ... Kód konfigurace s. 388
		Barva	Chrom	Barvy/RAL a speciální barvy	Chrom	Barvy/RAL a speciální barvy	Chrom	Barvy/RAL a speciální barvy	Chrom	Barvy/RAL a speciální barvy	Chrom	Barvy/RAL a speciální barvy	Chrom	Barvy/RAL a speciální barvy	Chrom	Barvy/RAL a speciální barvy	Chrom			
640	200	120	120	325	416	333	424	352	443	303	394	313	404	293	384	279	370	279	370	WLEAS064020...
960	200	200	120	355	496	362	504	382	523	333	474	343	484	323	464	308	450	308	450	WLEAS096020...
1280	200	300	200	397	575	404	582	424	602	375	553	384	563	365	543	350	528	350	528	WLEAS128020...
1600	200	300	200	440	651	447	659	467	678	418	629	427	639	408	619	393	605	393	605	WLEAS160020...
1920	200	400	-	482	-	489	-	509	-	459	-	469	-	450	-	435	-	435	-	WLEAS192020...

Easy DW (dělicí stěna kolmá)



Barva je zahrnuta v ceně



výběr připojení v ceně

DOPORUČUJEME PRO PŘIPOJENÍ O1:



Integrovaná sada termostatická s ponornou trubicí, chrom



WRZT5G7-CR: 151 EUR

Stránka: 334



Sada krycí integrovaná, Chrom

TGPCR002: 38 EUR

Stránka: 374



Police EASY - masivní dřevo

WRPEAS020 KBUK: 41 EUR

WRPEAS020 KDAB: 43 EUR

WRPEAS020 KTEK: 74 EUR

Stránka: 309



RADIÁTOR VODNÍ

Připojení:



A ↕ [mm]	B ↔ [mm]	75/65/20°C [W]	55/45/20°C [W]	 [W]	Barvy RAL a speciální barvy Cena bez DPH [EUR]	Kód produktu ... Kód konfigurace s. 385
1660	200	314	170	300	431	WGAEW166020...
1980	200	378	204	400	474	WGAEW198020...

Easy DW E



Barva je zahrnuta v ceně



výběr připojení v ceně

RADIÁTOR ELEKTRICKÝ (CENA VČETNĚ NÁPLNĚ A ZVOLENÉ TOPNÉ TYČE)

Připojení:

E1



A ↕ [mm]	B ↔ [mm]	Výkon [W]	MEG Cena bez DPH [EUR]	MOA/DRY/ TDY Cena bez DPH [EUR] (MOAIR: +12 EUR) (MOABLUE: +38 EUR)	ONE Cena bez DPH [EUR] (Nezabudovaná, v 8cm profilu v barvě radiátoru)	REG 2 Cena bez DPH [EUR]	REG 3 Cena bez DPH [EUR]	SIM Cena bez DPH [EUR]	Terma Split třída I Cena bez DPH [EUR] (nezapomeňte si koupit regulátor KTX)	Smart Split třída I Cena bez DPH [EUR] (nezapomeňte si koupit SMARTWi-Fi regulátor VEO)	Kód produktu ... Kód konfigurace s. 388
1660	200	300	526	533	553	504	514	494	479	479	WLEAW166020...
1980	200	400	569	576	596	547	557	537	522	522	WLEAW198020...

Easy One



Barva je zahrnutá v ceně



výběr připojení v ceně



TŘÍDA I



45-60°C/2



P-W-U



120-1000W



IR



IPx5



2h/1



IR

SADA OBSAHUJE:

Radiátor se zabudovanou topnou tyčí One. Funkce topné tyče ONE: Stránka 287.

DOPORUČUJEME PRO PŘIPOJENÍ S1 i S8:



Integrovaná sada termostatická s ponornou trubicí, Chrom

WRZT5G5-CR: 151 EUR

WRZT5G6-CR: 151 EUR

Stránka: 334



Sada krycí integrovaná, Chrom

TGPCR002: 38 EUR

Stránka: 374



Police EASY - Masivní dřevo

WRPEAS020 KBUK: 41 EUR

WRPEAS020 KDAB: 43 EUR

WRPEAS020 KTEK: 74 EUR

Stránka: 309



RADIÁTOR VODNĚ-ELEKTRICKÝ (CENA VČETNĚ ZABUDOVANÉ TOPNÉ TYČE ONE)

Připojení:

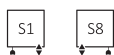

Vyber druh kabelu:

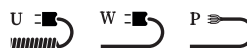

A ↓ [mm]	B ↔ [mm]	Barva ze vzorníku RAL a speciálních barev			Galvanický povrch Chrom			Barvy RAL a speciální barvy Cena bez DPH [EUR]	Chrom Cena bez DPH [EUR]	Kód produktu ... Kód konfigurace s. 386
		75/65/20°C [W]	55/45/20°C [W]	[W]	75/65/20°C [W]	55/45/20°C [W]	[W]			
960	200	187	102	200	131	67	120	357	499	WZEAN096020...
1280	200	251	136	300	176	90	200	399	577	WZEAN128020...
1600	200	314	170	300	220	112	200	442	654	WZEAN160020...
1920	200	378	204	400	-	-	-	484	-	WZEAN192020...

Easy One E



Barva je zahrnuta v ceně



výběr připojení v ceně



RADIÁTOR ELEKTRICKÝ (CENA VČETNĚ NÁPLNĚ A ZABUDOVANÉ TOPNÉ TYČE ONE)

Připojení:



A ↕ [mm]	B ↔ [mm]	Výkon [W]		Barvy RAL a speciální barvy Cena bez DPH [EUR]	Chrom Cena bez DPH [EUR]	Kód produktu ... Kód konfigurace s. 387
		Barva	Chrom			
960	200	200	120	376	517	WWEAN096020...
1280	200	300	200	418	596	WWEAN128020...
1600	200	300	200	461	672	WWEAN160020...
1920	200	400	–	502	–	WWEAN192020...

Fiona



DOPORUČUJEME PRO PŘIPOJENÍ SX:



Sada tříosová termostatická, Chrom

WRZTCG1-CR: 143EUR

WRZTCG2-CR: 143EUR

Stránka: 330



Sada krycí dvojitá, Chrom

TGPCR001: 27EUR

Stránka: 373



Háček bodový YO!

WRWYOY001*: 4EUR

Stránka: 316



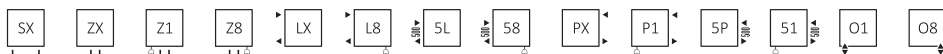

RADIÁTOR VODNÍ / VODNĚ-ELEKTRICKÝ (DOKOUPIT TOPNOU TYČ)

Připojení:



A ↕ [mm]	B ↔ [mm]	Barva ze vzorníku RAL a speciálních barev			Galvanický povrch Chrom			Barvy RAL a speciální barvy Cena bez DPH [EUR]	Chrom Cena bez DPH [EUR]	Kód produktu ... Kód konfigurace s. 385
		75/65/20°C [W]	55/45/20°C [W]	[W]	75/65/20°C [W]	55/45/20°C [W]	[W]			
660	400	241	128	300	169	90	200	180	349	WGFIN066040...
660	430	255	136	300	179	95	200	183	357	WGFIN066043...
660	480	280	149	300	196	104	200	185	370	WGFIN066048...
660	500	289	154	300	202	108	200	186	375	WGFIN066050...
660	530	304	162	300	212	113	200	190	383	WGFIN066053...
660	580	327	175	300	229	123	200	194	400	WGFIN066058...
660	600	336	180	400	235	126	200	195	404	WGFIN066060...
660	630	350	188	400	245	132	300	198	413	WGFIN066063...
660	680	373	200	400	261	140	300	200	426	WGFIN066068...
900	400	322	172	300	225	120	200	195	400	WGFIN090040...
900	430	342	182	400	240	127	300	198	410	WGFIN090043...
900	480	375	200	400	262	140	300	202	429	WGFIN090048...
900	500	388	206	400	272	144	300	205	435	WGFIN090050...
900	530	407	217	400	285	152	300	207	445	WGFIN090053...
900	580	438	234	400	307	164	300	211	475	WGFIN090058...
900	600	451	241	400	316	169	300	214	479	WGFIN090060...
900	630	469	251	400	329	176	300	217	493	WGFIN090063...
900	680	500	267	600	350	187	400	222	509	WGFIN090068...
1140	400	405	216	400	284	151	300	214	477	WGFIN114040...

Fiona

A ↕ [mm]	B ↔ [mm]	Barva ze vzorníku RAL a speciálních barev			Galvanický povrch Chrom			Barvy RAL a speciální barvy Cena bez DPH [EUR]	Chrom Cena bez DPH [EUR]	Kód produktu ... Kód konfigurace s. 385
		75/65/20°C [W]	55/45/20°C [W]	 [W]	75/65/20°C [W]	55/45/20°C [W]	 [W]			
1140	430	430	228	400	301	160	300	216	488	WGFIN114043...
1140	480	471	250	400	329	175	300	221	507	WGFIN114048...
1140	500	487	259	600	341	181	400	222	515	WGFIN114050...
1140	530	511	272	600	358	190	400	226	530	WGFIN114053...
1140	580	550	293	600	385	205	400	233	558	WGFIN114058...
1140	600	566	301	600	396	211	400	234	565	WGFIN114060...
1140	630	589	314	600	413	220	400	241	581	WGFIN114063...
1140	680	628	335	600	440	235	400	246	601	WGFIN114068...
1380	400	488	260	600	342	182	400	230	531	WGFIN138040...
1380	430	518	275	600	363	193	400	232	544	WGFIN138043...
1380	480	568	301	600	397	211	400	239	570	WGFIN138048...
1380	500	587	311	600	411	218	400	242	581	WGFIN138050...
1380	530	616	327	600	431	229	400	248	597	WGFIN138053...
1380	580	664	352	600	465	246	400	254	637	WGFIN138058...
1380	600	683	363	800	478	254	400	257	645	WGFIN138060...
1380	630	711	378	800	498	265	600	261	662	WGFIN138063...
1380	680	757	402	800	530	281	600	268	688	WGFIN138068...
1620	400	573	304	600	401	213	400	247	591	WGFIN162040...
1620	430	608	322	600	426	225	400	250	608	WGFIN162043...
1620	480	666	353	600	466	247	400	259	638	WGFIN162048...
1620	500	689	365	800	482	256	600	261	650	WGFIN162050...
1620	530	723	383	800	506	268	600	264	666	WGFIN162053...
1620	580	779	413	800	545	289	600	271	712	WGFIN162058...
1620	600	801	424	800	561	297	600	275	724	WGFIN162060...
1620	630	834	442	800	584	309	600	281	742	WGFIN162063...
1620	680	889	471	1000	622	330	600	289	772	WGFIN162068...
1860	400	660	350	600	-	-	-	260	-	WGFIN186040...
1860	430	700	370	800	-	-	-	265	-	WGFIN186043...
1860	480	767	405	800	-	-	-	274	-	WGFIN186048...
1860	500	793	419	800	-	-	-	277	-	WGFIN186050...
1860	530	832	440	800	-	-	-	282	-	WGFIN186053...
1860	580	897	474	1000	-	-	-	292	-	WGFIN186058...
1860	600	922	487	1000	-	-	-	296	-	WGFIN186060...
1860	630	960	507	1000	-	-	-	301	-	WGFIN186063...
1860	680	1023	541	1000	-	-	-	309	-	WGFIN186068...

Fiona E



Barva je zahrnuta v ceně



výběr připojení v ceně

RADIÁTOR ELEKTRICKÝ (CENA VČETNĚ NÁPLNĚ A ZVOLENÉ TOPNÉ TYČE)

E1

E8

A ↓ [mm]	B ↔ [mm]	Výkon [W]		MEG Cena bez DPH [EUR]		MOA/DRY/TDY Cena bez DPH [EUR] (MOAIR: +12 EUR) (MOA BLUE: +38 EUR)		ONE Cena bez DPH [EUR] (Nezabudovaná, v 8cm profilu v barvě radiátoru)		REG 2 Cena bez DPH [EUR]		REG 3 Cena bez DPH [EUR]		SIM Cena bez DPH [EUR]		Terma Split třída I Cena bez DPH [EUR] (nezapomeňte si koupit regulátor KTX)		Smart Split třída I Cena bez DPH [EUR] (nezapomeňte si koupit SMART Wi-Fi regulátor VEO)		Kód produktu ... Kód konfigurace s. 388
		Barva	Chrom	Barvy PAL a speciální barvy	Chrom	Barvy PAL a speciální barvy	Chrom	Barvy PAL a speciální barvy	Chrom	Barvy PAL a speciální barvy	Chrom	Barvy PAL a speciální barvy	Chrom	Barvy PAL a speciální barvy	Chrom	Barvy PAL a speciální barvy	Chrom	Barvy PAL a speciální barvy	Chrom	
660	400	300	120	275	443	282	451	302	471	253	421	263	431	243	412	228	397	228	397	WLFIN066040...
660	430	300	200	277	452	285	459	305	479	255	430	265	440	246	420	231	405	231	405	WLFIN066043...
660	480	300	200	280	464	287	472	307	491	258	442	268	452	248	432	233	418	233	418	WLFIN066048...
660	500	300	200	281	469	289	477	308	496	259	447	269	457	249	437	234	423	234	423	WLFIN066050...
660	530	300	200	285	478	292	485	312	505	263	456	273	466	253	446	238	431	238	431	WLFIN066053...
660	580	300	200	289	495	296	502	316	522	266	473	276	483	257	463	242	448	242	448	WLFIN066058...
660	600	400	200	290	499	297	506	317	526	268	477	277	487	258	467	243	452	243	452	WLFIN066060...
660	630	400	300	292	507	300	515	319	534	270	485	280	495	260	475	246	461	246	461	WLFIN066063...
660	680	400	300	295	521	302	528	322	548	273	499	282	509	263	489	248	474	248	474	WLFIN066068...
900	400	300	200	290	495	297	502	317	522	268	473	277	483	258	463	243	448	243	448	WLFIN090040...
900	430	400	300	292	505	300	512	319	532	270	483	280	493	260	473	246	458	246	458	WLFIN090043...
900	480	400	300	297	523	305	531	324	550	275	501	285	511	265	491	250	477	250	477	WLFIN090048...
900	500	400	300	300	530	307	537	327	557	277	507	287	517	268	498	253	483	253	483	WLFIN090050...
900	530	400	300	302	539	309	547	329	566	280	517	290	527	270	507	255	493	255	493	WLFIN090053...
900	580	400	300	306	570	313	577	333	597	284	548	293	558	274	538	259	523	259	523	WLFIN090058...
900	600	400	300	307	574	314	581	334	601	285	552	295	562	275	542	260	527	260	527	WLFIN090060...
900	630	400	300	312	586	319	593	339	613	290	564	300	574	280	554	265	539	265	539	WLFIN090063...
900	680	600	400	316	603	323	611	343	630	293	581	303	591	284	571	269	557	269	557	WLFIN090068...
1140	400	400	300	308	571	316	579	335	598	286	549	296	559	276	539	261	525	261	525	WLFIN114040...
1140	430	400	300	311	582	318	590	338	609	289	560	298	570	279	550	264	536	264	536	WLFIN114043...
1140	480	400	300	316	602	323	609	343	629	293	580	303	590	284	570	269	555	269	555	WLFIN114048...
1140	500	600	400	317	609	324	617	344	637	295	587	305	597	285	577	270	563	270	563	WLFIN114050...
1140	530	600	400	321	623	328	630	348	650	298	601	308	611	289	591	274	576	274	576	WLFIN114053...
1140	580	600	400	328	653	335	660	355	680	306	630	316	640	296	621	281	606	281	606	WLFIN114058...
1140	600	600	400	329	660	336	667	356	687	307	638	317	648	297	628	282	613	282	613	WLFIN114060...
1140	630	600	400	335	676	343	683	362	703	313	654	323	664	303	644	289	629	289	629	WLFIN114063...
1140	680	600	400	340	696	348	703	367	723	318	673	328	683	308	664	293	649	293	649	WLFIN114068...

Fiona E

A ↕ [mm]	B ↔ [mm]	Výkon [W]		MEG		MOA/DRY/TDY		ONE		REG 2		REG 3		SIM		Terma Split třída I		Smart Split třída I		Kód produktu ... Kód konfigurace s. 388
				Cena bez DPH [EUR]		Cena bez DPH [EUR] (MOAIR: +12 EUR) (MOABLU: +38 EUR)		Cena bez DPH [EUR] (Nezabudovaná, v 8cm profilu v barvě radiátoru)		Cena bez DPH [EUR]		Cena bez DPH [EUR]		Cena bez DPH [EUR]		Cena bez DPH [EUR] (nezapomeňte si koupit regulátor KTX)		Cena bez DPH [EUR] (nezapomeňte si koupit SMART Wi-Fi regulátor VEO)		
		Bava	Chrom	Bavý Pál a speciální barvy	Chrom	Bavý Pál a speciální barvy	Chrom	Bavý Pál a speciální barvy	Chrom	Bavý Pál a speciální barvy	Chrom	Bavý Pál a speciální barvy	Chrom	Bavý Pál a speciální barvy	Chrom	Bavý Pál a speciální barvy	Chrom	Bavý Pál a speciální barvy	Chrom	
1380	400	600	400	324	624	332	632	351	651	302	602	312	612	292	592	277	577	277	577	WLFIN138040...
1380	430	600	400	327	639	334	646	354	666	305	617	314	627	295	607	280	592	280	592	WLFIN138043...
1380	480	600	400	334	665	341	672	361	692	312	643	322	653	302	633	287	618	287	618	WLFIN138048...
1380	500	600	400	336	676	344	683	364	703	314	654	324	664	305	644	290	629	290	629	WLFIN138050...
1380	530	600	400	343	692	350	699	370	719	321	670	330	680	311	660	296	645	296	645	WLFIN138053...
1380	580	600	400	349	731	356	739	376	758	327	709	336	719	317	699	302	684	302	684	WLFIN138058...
1380	600	800	400	351	740	359	747	378	767	329	718	339	728	319	708	305	693	305	693	WLFIN138060...
1380	630	800	600	356	757	364	764	383	784	334	735	344	745	324	725	309	710	309	710	WLFIN138063...
1380	680	800	600	362	783	370	790	389	810	340	761	350	771	330	751	316	736	316	736	WLFIN138068...
1620	400	600	400	340	686	348	693	367	713	318	664	328	673	308	654	293	639	293	639	WLFIN162040...
1620	430	600	400	345	703	352	710	372	730	323	681	333	691	313	671	298	656	298	656	WLFIN162043...
1620	480	600	400	354	732	361	740	381	759	332	710	341	720	322	700	307	686	307	686	WLFIN162048...
1620	500	800	600	356	745	364	752	383	772	334	723	344	732	324	713	309	698	309	698	WLFIN162050...
1620	530	800	600	359	761	366	768	386	788	336	739	346	748	327	729	312	714	312	714	WLFIN162053...
1620	580	800	600	366	806	373	814	393	833	344	784	354	794	334	774	319	759	319	759	WLFIN162058...
1620	600	800	600	370	819	377	826	397	846	348	796	357	806	338	787	323	772	323	772	WLFIN162060...
1620	630	800	600	376	837	383	844	403	864	354	815	364	825	344	805	329	790	329	790	WLFIN162063...
1620	680	1000	600	383	866	391	874	410	894	361	844	371	854	351	834	336	820	336	820	WLFIN162068...
1860	400	600	-	354	-	361	-	381	-	332	-	341	-	322	-	307	-	307	-	WLFIN186040...
1860	430	800	-	360	-	367	-	387	-	338	-	348	-	328	-	313	-	313	-	WLFIN186043...
1860	480	800	-	368	-	376	-	396	-	346	-	356	-	336	-	322	-	322	-	WLFIN186048...
1860	500	800	-	372	-	380	-	399	-	350	-	360	-	340	-	325	-	325	-	WLFIN186050...
1860	530	800	-	377	-	384	-	404	-	355	-	365	-	345	-	330	-	330	-	WLFIN186053...
1860	580	1000	-	387	-	394	-	414	-	365	-	375	-	355	-	340	-	340	-	WLFIN186058...
1860	600	1000	-	389	-	397	-	416	-	367	-	377	-	357	-	343	-	343	-	WLFIN186060...
1860	630	1000	-	396	-	403	-	423	-	373	-	383	-	364	-	349	-	349	-	WLFIN186063...
1860	680	1000	-	404	-	412	-	431	-	382	-	392	-	372	-	357	-	357	-	WLFIN186068...

Fiona One



Barva je zahrnuta v ceně



výběr připojení v ceně



TŘÍDA I



45-60°C/2



P-W-U



120-1000W



IR



IPx5



2h/1



SADA OBSAHUJE:

Radiátor se zabudovanou topnou tyčí One. Funkce topné tyče ONE: Stránka 287.

DOPORUČUJEME PRO PŘIPOJENÍ S1 i S8:



Integrovaná sada termostatická s ponornou trubicí, Chrom

WRZT5G5-CR: 151EUR

WRZT5G6-CR: 151EUR

Stránka: 334



Sada krycí integrovaná, Chrom

TGPCR002: 38EUR

Stránka: 374



Regulátor TTIR1

TGRTBI001: 104EUR

Stránka: 304



Háček bodový YO!

WRWYOY001*: 4EUR

Stránka: 316



RADIÁTOR VODNĚ-ELEKTRICKÝ (CENA VČETNĚ ZABUDOVANÉ TOPNÉ TYČE ONE)

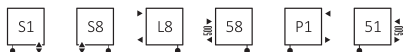

Připojení:

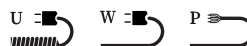

Vyber druh kabelu:



A ↕ [mm]	B ↔ [mm]	Barva ze vzorníku RAL a speciálních barev			Galvanický povrch Chrom			Barvy RAL a speciální barvy Cena bez DPH [EUR]	Chrom Cena bez DPH [EUR]	Kód produktu ... Kód konfigurace s. 386
		75/65/20°C [W]	55/45/20°C [W]		75/65/20°C [W]	55/45/20°C [W]				
900	400	305	162	400	214	113	200	292	498	WZFIE090040...
900	430	342	182	400	240	127	300	295	507	WZFIE090043...
900	480	375	200	400	262	140	300	300	526	WZFIE090048...
900	500	382	203	400	267	142	300	302	532	WZFIE090050...
900	530	407	217	400	285	152	300	305	542	WZFIE090053...
900	580	438	234	400	307	164	300	308	573	WZFIE090058...
900	600	458	244	400	321	171	300	309	576	WZFIE090060...
900	630	469	251	400	329	176	300	314	589	WZFIE090063...
900	680	500	267	400	350	187	300	318	606	WZFIE090068...
1140	400	385	204	400	270	143	300	311	574	WZFIE114040...
1140	430	430	228	400	301	160	300	313	585	WZFIE114043...
1140	480	471	250	400	329	175	300	318	605	WZFIE114048...
1140	500	481	256	400	337	179	400	319	612	WZFIE114050...
1140	530	511	272	600	358	190	400	323	625	WZFIE114053...
1140	580	550	293	600	385	205	400	330	655	WZFIE114058...
1140	600	577	307	600	404	215	400	332	662	WZFIE114060...

A ⇕ [mm]	B ↔ [mm]	Barva ze vzorníku RAL a speciálních barev			Galvanický povrch Chrom			Barvy RAL a speciální barvy Cena bez DPH [EUR]	Chrom Cena bez DPH [EUR]	Kód produktu ... Kód konfigurace s. 386
		75/65/20°C [W]	55/45/20°C [W]	 [W]	75/65/20°C [W]	55/45/20°C [W]	 [W]			
1140	630	589	314	600	413	220	400	338	678	WZFIE114063...
1140	680	628	335	600	440	235	400	343	698	WZFIE114068...
1380	400	464	246	600	325	172	400	327	627	WZFIE138040...
1380	430	518	275	600	363	193	400	329	641	WZFIE138043...
1380	480	568	301	600	397	211	400	336	667	WZFIE138048...
1380	500	580	308	600	406	216	400	339	678	WZFIE138050...
1380	530	616	327	600	431	229	400	345	694	WZFIE138053...
1380	580	664	352	600	465	246	400	351	734	WZFIE138058...
1380	600	696	370	600	487	259	400	354	742	WZFIE138060...
1380	630	711	378	800	498	265	600	359	759	WZFIE138063...
1380	680	757	402	800	530	281	600	365	785	WZFIE138068...
1620	400	543	287	800	380	201	400	343	688	WZFIE162040...
1620	430	608	322	600	426	225	400	348	705	WZFIE162043...
1620	480	666	353	600	466	247	400	356	735	WZFIE162048...
1620	500	679	359	600	475	251	600	359	747	WZFIE162050...
1620	530	723	383	800	506	268	600	361	763	WZFIE162053...
1620	580	779	413	800	545	289	600	368	809	WZFIE162058...
1620	600	815	432	800	571	302	600	372	821	WZFIE162060...
1620	630	834	442	800	584	309	600	378	839	WZFIE162063...
1620	680	889	471	800	622	330	600	386	869	WZFIE162068...
1860	400	623	329	800	-	-	-	356	-	WZFIE186040...
1860	430	700	370	800	-	-	-	362	-	WZFIE186043...
1860	480	767	405	800	-	-	-	371	-	WZFIE186048...
1860	500	778	411	800	-	-	-	375	-	WZFIE186050...
1860	530	832	440	800	-	-	-	380	-	WZFIE186053...
1860	580	897	474	1000	-	-	-	389	-	WZFIE186058...
1860	600	934	493	1000	-	-	-	392	-	WZFIE186060...
1860	630	960	507	1000	-	-	-	398	-	WZFIE186063...
1860	680	1023	541	1000	-	-	-	407	-	WZFIE186068...

Fiona One E



Barva je zahrnuta v ceně

výběr připojení v ceně

TŘÍDA I

45-60°C/2

P-W-U

120-1000W

IR

IPx5

2h/1

SSS

IR

RADIÁTOR ELEKTRICKÝ (CENA VČETNĚ NÁPLNĚ A ZABUDOVANÉ TOPNÉ TYČE ONE)

Připojení:



A ↕ [mm]	B ↔ [mm]	Výkon [W]		Barvy RAL a speciální barvy Cena bez DPH [EUR]	Chrom Cena bez DPH [EUR]	Kód produktu ... Kód konfigurace s. 387
		Barva	Chrom			
900	400	400	200	311	516	WWFIE090040...
900	430	400	300	313	526	WWFIE090043...
900	480	400	300	318	544	WWFIE090048...
900	500	400	300	321	550	WWFIE090050...
900	530	400	300	323	560	WWFIE090053...
900	580	400	300	327	591	WWFIE090058...
900	600	400	300	328	595	WWFIE090060...
900	630	400	300	333	607	WWFIE090063...
900	680	400	300	336	624	WWFIE090068...
1140	400	400	300	329	592	WWFIE114040...
1140	430	400	300	332	603	WWFIE114043...
1140	480	400	300	336	623	WWFIE114048...
1140	500	400	400	338	630	WWFIE114050...
1140	530	600	400	341	644	WWFIE114053...
1140	580	600	400	349	673	WWFIE114058...
1140	600	600	400	350	681	WWFIE114060...
1140	630	600	400	356	697	WWFIE114063...
1140	680	600	400	361	716	WWFIE114068...
1380	400	600	400	345	645	WWFIE138040...
1380	430	600	400	348	660	WWFIE138043...
1380	480	600	400	355	686	WWFIE138048...
1380	500	600	400	357	697	WWFIE138050...
1380	530	600	400	364	713	WWFIE138053...
1380	580	600	400	370	752	WWFIE138058...
1380	600	600	400	372	761	WWFIE138060...
1380	630	800	600	377	778	WWFIE138063...
1380	680	800	600	383	804	WWFIE138068...

Fiona One E

A ↕ [mm]	B ↔ [mm]	Výkon [W]		Barvy RAL a speciální barvy Cena bez DPH [EUR]	Chrom Cena bez DPH [EUR]	Kód produktu ... Kód konfigurace s. 387
		Barva	Chrom			
1620	400	800	400	361	707	WWFIE162040...
1620	430	600	400	366	724	WWFIE162043...
1620	480	600	400	375	753	WWFIE162048...
1620	500	600	600	377	766	WWFIE162050...
1620	530	800	600	380	782	WWFIE162053...
1620	580	800	600	387	827	WWFIE162058...
1620	600	800	600	391	839	WWFIE162060...
1620	630	800	600	397	858	WWFIE162063...
1620	680	800	600	404	887	WWFIE162068...
1860	400	800	–	375	–	WWFIE186040...
1860	430	800	–	381	–	WWFIE186043...
1860	480	800	–	389	–	WWFIE186048...
1860	500	800	–	393	–	WWFIE186050...
1860	530	800	–	398	–	WWFIE186053...
1860	580	1000	–	408	–	WWFIE186058...
1860	600	1000	–	410	–	WWFIE186060...
1860	630	1000	–	416	–	WWFIE186063...
1860	680	1000	–	425	–	WWFIE186068...

Forte V10



Barva je zahrnuta v ceně



výběr připojení v ceně

DOPORUČUJEME PRO PŘIPOJENÍ ZX:



Integrovaná sada termostatická, Chrom

WRZT5G1-CR: 145 EUR

WRZT5G2-CR: 145 EUR

Stránka: 332



Sada krycí integrovaná, Chrom

TGPCR002: 38 EUR

Stránka: 374

RADIÁTOR VODNÍ

Připojení:

Výška [mm] 550÷600:

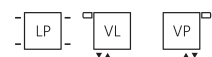

Výška [mm] 1000÷1800:

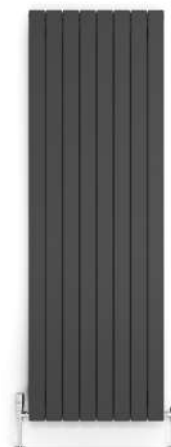

A ↕ [mm]	B ↔ [mm]	75/65/20°C [W]	55/45/20°C [W]	Barvy RAL a speciální barvy* Cena bez DPH [EUR]	Kód produktu ... Kód konfigurace s. 385
550	440	281	147	268	TG10F055044...
550	588	374	195	315	TG10F055058...
550	810	515	269	383	TG10F055081...
550	1032	655	342	452	TG10F055103...
550	1254	796	416	521	TG10F055125...
600	440	304	159	279	TG10F060044...
600	588	406	212	328	TG10F060058...
600	810	558	292	402	TG10F060081...
600	1032	710	371	476	TG10F060103...
600	1254	862	451	550	TG10F060125...
1000	514	564	295	375	TG10F100051...
1000	588	645	338	411	TG10F100058...
1200	514	660	345	420	TG10F120051...
1200	588	754	394	462	TG10F120058...
1400	514	750	391	465	TG10F140051...
1400	588	857	447	513	TG10F140058...
1800	292	522	277	370	TG10F180029...
1800	366	652	345	432	TG10F180036...
1800	440	782	414	493	TG10F180044...
1800	514	913	484	554	TG10F180051...
1800	588	1043	553	616	TG10F180058...

*Dostupný pouze v barvách: Bílá - RAL 9016 (916), Metallic Grey (MGR), Černá Mat - Soft 9005 (S95)

Forte V20



Barva je zahrnuta v ceně



výběr připojení v ceně

DOPORUČUJEME PRO PŘIPOJENÍ ZX:



Integrovaná sada termostatická, Chrom

 WRZT5G1-CR: 145 EUR

 WRZT5G2-CR: 145 EUR

Stránka: 332



Sada krycí integrovaná, Chrom

TGPCR002: 38 EUR

Stránka: 374



RADIÁTOR VODNÍ

Připojení:

Výška [mm] 550÷600:

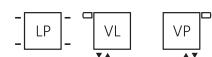

A ↕ [mm]	B ↔ [mm]	75/65/20°C [W]	55/45/20°C [W]	Barvy RAL a speciální barvy* Cena bez DPH [EUR]	Kód produktu ... Kód konfigurace s. 385
550	440	429	219	338	TG20F055044...
550	588	571	292	409	TG20F055058...
550	810	786	402	514	TG20F055081...
550	1032	1000	511	620	TG20F055103...
550	1254	1214	621	727	TG20F055125...
600	440	464	237	355	TG20F060044...
600	588	619	316	431	TG20F060058...
600	810	851	435	546	TG20F060081...
600	1032	1083	553	660	TG20F060103...
600	1254	1315	672	774	TG20F060125...
1600	292	739	370	506	TG20F160029...
1600	366	924	463	601	TG20F160036...
1600	440	1108	555	696	TG20F160044...
1600	514	1293	648	791	TG20F160051...
1600	588	1478	741	886	TG20F160058...
1800	292	814	407	552	TG20F180029...
1800	366	1017	508	658	TG20F180036...
1800	440	1221	610	764	TG20F180044...
1800	514	1424	712	871	TG20F180051...
1800	588	1628	814	977	TG20F180058...

*Dostupný pouze v barvách: Bílá - RAL 9016 (916), Metallic Grey (MGR), Černá Mat - Soft 9005 (S95)

Grid



Barva je zahrnuta v ceně



výběr připojení v ceně

DOPORUČUJEME PRO PŘIPOJENÍ ZX:



Integrovaná sada termostatická, Chrom

WRZT5G1-CR: 145 EUR

WRZT5G2-CR: 145 EUR

Stránka: 332



Sada krycí integrovaná, Chrom

TGPCR002: 38 EUR

Stránka: 374



RADIÁTOR VODNÍ / VODNĚ-ELEKTRICKÝ (DOKOUPIT TOPNOU TYČ)

Připojení:

Výška [mm] 510:



Výška [mm] 630÷1830:

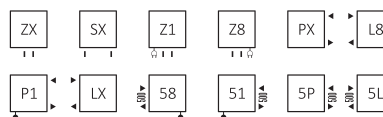

A ↓ [mm]	B ↔ [mm]	75/65/20°C [W]	55/45/20°C [W]	 [W]	Barvy RAL a speciální barvy Cena bez DPH [EUR]	Kód produktu ... Kód konfigurace s. 385
510	500	217	123	200	253	WGGRD051050...
630	500	262	145	300	274	WGGRD063050...
750	500	306	167	300	294	WGGRD075050...
870	500	351	189	400	313	WGGRD087050...
990	500	396	211	400	334	WGGRD099050...
1110	500	440	234	400	354	WGGRD111050...
1350	500	529	271	600	393	WGGRD135050...
1590	500	618	308	600	432	WGGRD159050...
1830	500	707	342	800	471	WGGRD183050...

Grid E



Barva je zahrnuta v ceně



výběr připojení v ceně

RADIÁTOR ELEKTRICKÝ (CENA VČETNĚ NÁPLNĚ A ZVOLENÉ TOPNÉ TYČE)

Připojení:

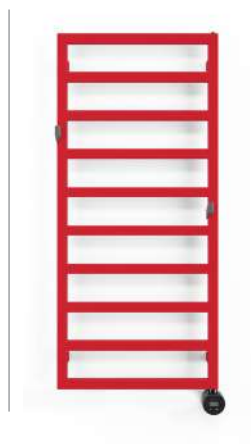

A ↕ [mm]	B ↔ [mm]	Výkon [W]	MEG Cena bez DPH [EUR]	MOA/DRY/TDY Cena bez DPH [EUR] (MOAIR: +12 EUR) (MOABLU: +38 EUR)	ONE Cena bez DPH [EUR] (Nezabudovaná, v 8cm profilu v barvě radiátoru)	REG 2 Cena bez DPH [EUR]	REG 3 Cena bez DPH [EUR]	SIM Cena bez DPH [EUR]	Terma Split třída I Cena bez DPH [EUR] (nezapomeňte si koupit regulátor KTX)	Smart Split třída I Cena bez DPH [EUR] (nezapomeňte si koupit SMART Wi-Fi regulátor VEO)	Kód produktu ... Kód konfigurace s.388
510	500	200	347	355	375	326	336	316	301	301	WLGRD051050...
630	500	300	368	376	396	347	357	337	322	322	WLGRD063050...
750	500	300	388	396	416	367	377	357	342	342	WLGRD075050...
870	500	400	407	415	435	386	396	376	361	361	WLGRD087050...
990	500	400	428	436	456	407	417	397	382	382	WLGRD099050...
1110	500	400	448	456	476	427	437	417	402	402	WLGRD111050...
1350	500	600	487	495	515	466	476	456	441	441	WLGRD135050...
1590	500	600	526	534	554	505	515	495	480	480	WLGRD159050...
1830	500	800	565	573	593	544	554	534	519	519	WLGRD183050...



Barva je zahrnuta v ceně



výběr připojení v ceně

DOPORUČUJEME PRO PŘIPOJENÍ ZX:



Integrovaná sada termostatická, Chrom

WRZT5G1-CR: 145 EUR

WRZT5G2-CR: 145 EUR

Stránka: 332



Sada krycí integrovaná, Chrom

TGPCR002: 38 EUR

Stránka: 374



RADIÁTOR VODNÍ

Připojení:

Výška [mm] 422÷502:



Výška [mm] 821÷1700:



A ⇕ [mm]	B ↔ [mm]	75/65/20°C [W]	55/45/20°C [W]	Barvy RAL a speciální barvy Cena bez DPH [EUR]	Kód produktu ... Kód konfigurace s.385
422	711	190	102	423	WGH2X042071...
502	1126	317	169	562	WGH2X050112...
821	486	248	131	484	WGH2X082048...
1220	486	346	180	589	WGH2X122048...
1700	573	500	258	752	WGH2X170057...

Incorner



Barva je zahrnuta v ceně

výběr připojení v ceně

DOPORUČUJEME PRO PŘIPOJENÍ SX:



Sada tříosová termostatická s možností montáže topné tyče skrz ventil, Chrom

WRZTCG4-CR: 147 EUR

WRZTCG5-CR: 147 EUR

Stránka: 331



Sada krycí dvojité, Chrom

TGPCR001: 27 EUR

Stránka: 373



RADIÁTOR VODNÍ / VODNĚ-ELEKTRICKÝ (DOKOUPIT TOPNOU TYČ)

Připojení:

Výška [mm] 465 ÷ 1545:



Výška [mm] 735 ÷ 1545



A ↑ [mm]	B ↔ [mm]	75/65/20°C [W]	55/45/20°C [W]	[W]	Barvy RAL a speciální barvy Cena bez DPH [EUR]	Kód produktu ... Kód konfigurace s. 385
465	350	284	153	300	301	WGQIN046035...
735	350	415	223	400	332	WGQIN073035...
1005	350	546	293	600	346	WGQIN100035...
1275	350	677	363	800	377	WGQIN127035...
1545	350	808	433	800	421	WGQIN154035...

Incorner E



Barva je zahrnutá v ceně



výběr připojení v ceně

RADIÁTOR ELEKTRICKÝ (CENA VČETNĚ NÁPLNĚ A ZVOLENÉ TOPNÉ TYČE)

Připojení:

E1

E8



A ↕ [mm]	B ↔ [mm]	Výkon [W]	MEG Cena bez DPH [EUR]	MOA/DRY/ TDY Cena bez DPH [EUR] (MOAIR: +12 EUR) (MOABLUE: +38 EUR)	ONE Cena bez DPH [EUR] (Nezabudovaná, v 8cm profilu v barvě radiátoru)	REG 2 Cena bez DPH [EUR]	REG 3 Cena bez DPH [EUR]	SIM Cena bez DPH [EUR]	Terma Split třída I Cena bez DPH [EUR] (nezapomeňte si koupit regulátor KTX)	Smart Split třída I Cena bez DPH [EUR] (nezapomeňte si koupit SMARTWi-Fi regulátor VEO)	Kód produktu ... Kód konfigurace s. 388
465	350	300	396	403	423	373	383	364	349	349	WLQIN046035...
735	350	400	426	434	453	404	414	394	380	380	WLQIN073035...
1005	350	600	441	448	468	419	429	409	394	394	WLQIN100035...
1275	350	800	472	479	499	450	459	440	425	425	WLQIN127035...
1545	350	800	516	523	543	494	504	484	469	469	WLQIN154035...

DOPORUČUJEME PRO PŘIPOJENÍ ZX:



Integrovaná sada termostatická,

Chrom

 WRZT5G1-CR: 145 EUR

 WRZT5G2-CR: 145 EUR

Stránka: 332



Sada krycí integrovaná, Chrom

TGPCR002: 38 EUR

Stránka: 374



Háček bodový ZIP V 20, Chrom

WRWZIP011 KCRO: 42 EUR

Stránka: 317



RADIÁTOR VODNÍ:

Připojení:



A ↓ [mm]	B ↔ [mm]	Barva ze vzorníku RAL a speciálních barev		Galvanický povrch Chrom		Barvy RAL a speciální barvy Cena bez DPH [EUR]	Chrom Cena bez DPH [EUR]	Kód produktu ... Kód konfigurace s. 385
		75/65/20°C [W]	55/45/20°C [W]	75/65/20°C [W]	55/45/20°C [W]			
1700	410	660	346	242	452	496	871	WGINB170041...
1700	530	858	450	315	480	526	1 046	WGINB170053...
1700	650	1056	554	387	521	571	1 208	WGINB170065...
1900	410	756	388	–	–	526	–	WGINB190041...
1900	530	982	506	–	–	557	–	WGINB190053...
1900	650	1209	612	–	–	601	–	WGINB190065...

Intra M



Barva je zahrnuta v ceně

výběr připojení v ceně

DOPORUČUJEME PRO PŘIPOJENÍ ZX, YL, YP:



Integrovaná sada termostatická,

Chrom

WRZT5G1-CR: 145 EUR

WRZT5G2-CR: 145 EUR

Stránka: 332



Sada krycí integrovaná, Chrom

TGPCR002: 38 EUR

Stránka: 374



Háček bodový ZIP V 20, Chrom

WRWZIP011 KCRO: 42 EUR

Stránka: 317



RADIÁTOR VODNÍ:

Připojení:



A ⇕ [mm]	B ↔ [mm]	Barva ze vzorníku RAL a speciálních barev		Galvanický povrch Chrom		Barvy RAL a speciální barvy Cena bez DPH [EUR]	Chrom Cena bez DPH [EUR]	Kód produktu ... Kód konfigurace s. 385
		75/65/20°C [W]	55/45/20°C [W]	75/65/20°C [W]	55/45/20°C [W]			
1700	440	528	277	370	192	586	871	WGINT170044...
1700	540	660	346	462	240	616	997	WGINT170054...
1700	640	925	485	647	337	661	1 230	WGINT170064...
1900	440	600	308	–	–	616	–	WGINT190044...
1900	540	762	392	–	–	645	–	WGINT190054...
1900	640	995	503	–	–	691	–	WGINT190064...

Iron D



Barva je zahrnuta v ceně

výběr připojení v ceně

DOPORUČUJEME PRO PŘIPOJENÍ ZX:



Sada komplexní integrovaný ventil s T- kusem s možností připojení topné tyče skrze ventil, Chrom

 WRZT5G14-CR: 188EUR

 WRZT5G15-CR: 188EUR

Stránka: 333



Sada krycí integrovaná, Chrom

TGPCR002: 38EUR

Stránka: 374



RADIÁTOR VODNÍ / VODNĚ-ELEKTRICKÝ (DOKOUPIT TOPNOU TYČ)

Připojení:



RADIÁTOR SE SKLÁDÁ ZE 2 ČÁSTÍ

ČÁST 1 – RADIÁTOR

A ↕ [mm]	B ↔ [mm]	75/65/20°C [W]	55/45/20°C [W]	 [W]	Barvy RAL a speciální barvy Cena bez DPH [EUR]	Kód produktu ... Kód konfigurace s. 385
730	400	453	240	400	425	WGIRD073040...
730	500	552	292	600	459	WGIRD073050...
730	600	649	344	600	486	WGIRD073060...
925	400	565	299	600	509	WGIRD092040...
925	500	689	364	800	553	WGIRD092050...
925	600	809	428	800	589	WGIRD092060...
1120	400	676	358	800	591	WGIRD112040...
1120	500	824	435	800	646	WGIRD112050...
1120	600	969	511	1000	691	WGIRD112060...
1315	400	788	417	800	667	WGIRD131040...
1315	500	960	506	1000	734	WGIRD131050...
1315	600	1128	593	1200	788	WGIRD131060...
1510	400	899	474	1000	748	WGIRD151040...
1510	500	1095	577	1000	825	WGIRD151050...
1510	600	1287	677	1200	887	WGIRD151060...
1705	400	1011	531	1000	828	WGIRD170040...
1705	500	1231	648	1200	917	WGIRD170050...
1705	600	1447	762	1500	969	WGIRD170060...

ČÁST 2 – SLOUP (KRYTÍ STOUPAČKOVÝCH PROFILŮ)

A ⇕ [mm]	B ↔ [mm]	Sloup (krytí stoupačkových profilů)	
		Barvy RAL a speciální barvy Cena bez DPH [EUR]	Kód produktu ... Kód konfigurace s. 390
730	400	78	WRCIRX073...
730	500	78	WRCIRX073...
730	600	78	WRCIRX073...
925	400	85	WRCIRX092...
925	500	85	WRCIRX092...
925	600	85	WRCIRX092...
1120	400	93	WRCIRX112...
1120	500	93	WRCIRX112...
1120	600	93	WRCIRX112...
1315	400	100	WRCIRX131...
1315	500	100	WRCIRX131...
1315	600	100	WRCIRX131...
1510	400	107	WRCIRX151...
1510	500	107	WRCIRX151...
1510	600	107	WRCIRX151...
1705	400	114	WRCIRX170...
1705	500	114	WRCIRX170...
1705	600	114	WRCIRX170...

Cena se počítá jako pro Ventily a příslušenství. Můžete také objednat ze Stránky 321

Iron D E



Barva je zahrnutá v ceně



výběr připojení v ceně

RADIÁTOR ELEKTRICKÝ (CENA VČETNĚ NÁPLNĚ A ZVOLENÉ TOPNÉ TYČE)

Připojení:

 E1

 E8

RADIÁTOR SE SKLÁDÁ ZE 2 ČÁSTÍ

ČÁST 1 – RADIÁTOR



A ↕ [mm]	B ↔ [mm]	Výkon [W]	MEG Cena bez DPH [EUR]	MOA/DRY/ TDY Cena bez DPH [EUR] (MOAIR: +12 EUR) (MOABLUE: +38 EUR)	ONE Cena bez DPH [EUR] (Nezabudovaná, v 8cm profilu v barvě radiátoru)	REG 2 Cena bez DPH [EUR]	REG 3 Cena bez DPH [EUR]	SIM Cena bez DPH [EUR]	Terma Split třída I Cena bez DPH [EUR] (nezapomeňte si koupit regulátor KTX)	Smart Split třída I Cena bez DPH [EUR] (nezapomeňte si koupit SMART Wi-Fi regulátor VEO)	Kód produktu ... Kód konfigurace s. 388
925	400	600	603	610	630	581	590	570	555	555	WLIRD092040...
925	500	800	647	654	674	625	635	615	600	600	WLIRD092050...
925	600	800	683	690	710	661	670	651	636	636	WLIRD092060...
1120	400	800	685	692	712	663	672	653	638	638	WLIRD112040...
1120	500	800	740	747	767	718	728	708	693	693	WLIRD112050...
1120	600	1000	785	792	812	763	772	753	738	738	WLIRD112060...
1315	400	800	761	768	788	739	749	729	714	714	WLIRD131040...
1315	500	1000	828	835	854	806	815	795	780	780	WLIRD131050...
1315	600	1200	882	889	–	860	869	849	–	834	WLIRD131060...
1510	400	1000	842	849	869	820	829	809	794	794	WLIRD151040...
1510	500	1000	919	926	946	897	906	886	871	871	WLIRD151050...
1510	600	1200	981	988	–	959	969	949	–	934	WLIRD151060...
1705	400	1000	922	929	949	900	909	890	874	874	WLIRD170040...
1705	500	1200	1011	1018	–	989	998	978	–	963	WLIRD170050...
1705	600	1500	–	–	–	–	–	1030	–	1015	WLIRD170060...

ČÁST 2 – SLOUP (KRYTÍ STOUPAČKOVÝCH PROFILŮ)

A ⇕ [mm]	B ↔ [mm]	Sloup (krytí stoupačkových profilů)	
		Barvy RAL a speciální barvy Cena bez DPH [EUR]	Kód produktu ... Kód konfigurace s.390
925	400	85	WRCIRX092...
925	500	85	WRCIRX092...
925	600	85	WRCIRX092...
1120	400	93	WRCIRX112...
1120	500	93	WRCIRX112...
1120	600	93	WRCIRX112...
1315	400	100	WRCIRX131...
1315	500	100	WRCIRX131...
1315	600	100	WRCIRX131...
1510	400	107	WRCIRX151...
1510	500	107	WRCIRX151...
1510	600	107	WRCIRX151...
1705	400	114	WRCIRX170...
1705	500	114	WRCIRX170...
1705	600	114	WRCIRX170...

Cena se počítá jako pro Ventily a příslušenství. Můžete také objednat ze Stránky 321

Iron S



Barva je zahrnuta v ceně

výběr připojení v ceně

DOPORUČUJEME PRO PŘIPOJENÍ GD:



Sada komplexní integrovaný ventil s T- kusem s možností připojení topné tyče skrze ventil, Chrom

WRZT5G14-CR: 188EUR

WRZT5G15-CR: 188EUR

Stránka: 333



Sada krycí integrovaná, Chrom

TGPCR002: 38EUR

Stránka: 374



RADIÁTOR VODNÍ / VODNĚ-ELEKTRICKÝ (DOKOUPIT TOPNOU TYČ)

Připojení:



RADIÁTOR SE SKLÁDÁ ZE 2 ČÁSTÍ

ČÁST 1 – RADIÁTOR

A ↕ [mm]	B ↔ [mm]	75/65/20°C [W]	55/45/20°C [W]	 [W]	Barvy RAL a speciální barvy Cena bez DPH [EUR]	Kód produktu ... Kód konfigurace s. 385
730	400	461	246	400	429	WGIRS073040...
730	500	567	302	600	457	WGIRS073050...
730	600	672	357	600	484	WGIRS073060...
925	400	578	307	600	512	WGIRS092040...
925	500	712	378	800	550	WGIRS092050...
925	600	843	446	800	586	WGIRS092060...
1120	400	695	368	800	595	WGIRS112040...
1120	500	855	452	800	642	WGIRS112050...
1120	600	1012	535	1000	687	WGIRS112060...
1315	400	810	427	800	676	WGIRS131040...
1315	500	996	525	1000	732	WGIRS131050...
1315	600	1180	622	1200	786	WGIRS131060...
1510	400	924	486	1000	762	WGIRS151040...
1510	500	1137	598	1000	823	WGIRS151050...
1510	600	1347	709	1200	885	WGIRS151060...
1705	400	1037	545	1000	839	WGIRS170040...
1705	500	1276	670	1200	914	WGIRS170050...
1705	600	1511	794	1500	985	WGIRS170060...

ČÁST 2 – SLOUP (KRYTÍ STOUPAČKOVÝCH PROFILŮ)

A ⇕ [mm]	B ↔ [mm]	Sloup (krytí stoupačkových profilů)	
		Barvy RAL a speciální barvy Cena bez DPH [EUR]	Kód produktu ... Kód konfigurace s. 390
730	400	78	WRCIRX073...
730	500	78	WRCIRX073...
730	600	78	WRCIRX073...
925	400	85	WRCIRX092...
925	500	85	WRCIRX092...
925	600	85	WRCIRX092...
1120	400	93	WRCIRX112...
1120	500	93	WRCIRX112...
1120	600	93	WRCIRX112...
1315	400	100	WRCIRX131...
1315	500	100	WRCIRX131...
1315	600	100	WRCIRX131...
1510	400	107	WRCIRX151...
1510	500	107	WRCIRX151...
1510	600	107	WRCIRX151...
1705	400	114	WRCIRX170...
1705	500	114	WRCIRX170...
1705	600	114	WRCIRX170...

Cena se počítá jako pro Ventily a příslušenství. Můžete také objednat ze Stránky 321

Iron S E



Barva je zahrnuta v ceně



výběr připojení v ceně

RADIÁTOR ELEKTRICKÝ (CENA VČETNĚ NÁPLNĚ A ZVOLENÉ TOPNÉ TYČE)

Připojení:



RADIÁTOR SE SKLÁDÁ ZE 2 ČÁSTÍ

ČÁST 1 – RADIÁTOR

A ↕ [mm]	B ↔ [mm]	Výkon [W]	MEG Cena bez DPH [EUR]	MOA/DRY/ TDY Cena bez DPH [EUR] (MOA IR: +12 EUR) (MOA BLUE: +38 EUR)	ONE Cena bez DPH [EUR] (Nezabudovaná, v 8cm profilu v barvě radiátoru)	REG 2 Cena bez DPH [EUR]	REG 3 Cena bez DPH [EUR]	SIM Cena bez DPH [EUR]	Terma Split třída I Cena bez DPH [EUR] (nezapomeňte si koupit regulátor KTX)	Smart Split třída I Cena bez DPH [EUR] (nezapomeňte si koupit SMART Wi-Fi regulátor VEO)	Kód produktu ... Kód konfigurace s. 388
925	400	600	606	613	632	584	593	573	558	558	WLIRS092040...
925	500	800	644	651	671	622	632	612	597	597	WLIRS092050...
925	600	800	680	687	707	658	667	647	632	632	WLIRS092060...
1120	400	800	689	696	716	667	676	657	642	642	WLIRS112040...
1120	500	800	736	743	763	714	724	704	689	689	WLIRS112050...
1120	600	1000	781	788	808	759	768	749	734	734	WLIRS112060...
1315	400	800	770	777	796	748	757	737	722	722	WLIRS131040...
1315	500	1000	826	833	853	804	814	794	779	779	WLIRS131050...
1315	600	1200	880	887	–	858	867	847	–	832	WLIRS131060...
1510	400	1000	856	862	882	833	843	823	808	808	WLIRS151040...
1510	500	1200	917	924	–	895	904	885	–	870	WLIRS151050...
1510	600	1500	–	–	–	–	–	947	–	932	WLIRS151060...
1705	400	1000	933	940	959	911	920	900	885	885	WLIRS170040...
1705	500	1200	1008	1015	–	986	995	976	–	961	WLIRS170050...
1705	600	1500	–	–	–	–	–	1046	–	1031	WLIRS170060...

ČÁST 2 – SLOUP (KRYTÍ STOUPAČKOVÝCH PROFILŮ)

A ⇕ [mm]	B ⇔ [mm]	Sloup (krytí stoupačkových profilů)	
		Barvy RAL a speciální barvy Cena bez DPH [EUR]	Kód produktu ... Kód konfigurace s.390
925	400	85	WRCIRX092...
925	500	85	WRCIRX092...
925	600	85	WRCIRX092...
1120	400	93	WRCIRX112...
1120	500	93	WRCIRX112...
1120	600	93	WRCIRX112...
1315	400	100	WRCIRX131...
1315	500	100	WRCIRX131...
1315	600	100	WRCIRX131...
1510	400	107	WRCIRX151...
1510	500	107	WRCIRX151...
1510	600	107	WRCIRX151...
1705	400	114	WRCIRX170...
1705	500	114	WRCIRX170...
1705	600	114	WRCIRX170...

Cena se počítá jako pro Ventily a příslušenství. Můžete také objednat ze Stránky 321

Kioto



Barva je zahrnuta v ceně

výběr připojení v ceně

DOPORUČUJEME PRO PŘIPOJENÍ SX:



Sada tříosová termostatická s možností montáže topné tyče skrz ventil, Chrom

  WRZTCG4-CR: 147 EUR

  WRZTCG5-CR: 147 EUR

Stránka: 331



Sada krycí dvojité, Chrom

TGPCR001: 27 EUR

Stránka: 373



RADIÁTOR VODNÍ / VODNĚ-ELEKTRICKÝ (DOKOUPIT TOPNOU TYČ)

Připojení:



A ↕ [mm]	B ↔ [mm]	75/65/20°C [W]	55/45/20°C [W]	 [W]	Barvy RAL a speciální barvy Cena bez DPH [EUR]	Kód produktu ... Kód konfigurace s. 385
555	480	324	176	300	333	WGKIO055048...
870	480	476	255	400	365	WGKIO087048...
1185	480	628	336	600	413	WGKIO118048...
1500	480	780	415	800	461	WGKIO150048...
1815	480	932	496	1000	509	WGKIO181048...

Kioto E



Barva je zahrnuta v ceně



výběr připojení v ceně

RADIÁTOR ELEKTRICKÝ (CENA VČETNĚ NÁPLNĚ A ZVOLENÉ TOPNÉ TYČE)

Připojení:

E1

E8



A ↕ [mm]	B ↔ [mm]	Výkon [W]	MEG Cena bez DPH [EUR]	MOA/DRY/ TDY Cena bez DPH [EUR] (MOAIR: +12 EUR) (MOABLUE: +38 EUR)	ONE Cena bez DPH [EUR] (Nezabudovaná, v 8cm profilu v barvě radiátoru)	REG 2 Cena bez DPH [EUR]	REG 3 Cena bez DPH [EUR]	SIM Cena bez DPH [EUR]	Terma Split třída I Cena bez DPH [EUR] (nezapomeňte si koupit regulátor KTX)	Smart Split třída I Cena bez DPH [EUR] (nezapomeňte si koupit SMARTWi-Fi regulátor VEO)	Kód produktu ... Kód konfigurace s. 388
555	480	300	427	435	455	405	415	396	381	381	WLKIO055048...
870	480	400	459	467	487	437	447	427	413	413	WLKIO087048...
1185	480	600	507	515	534	485	495	475	461	461	WLKIO118048...
1500	480	800	555	563	582	533	543	523	509	509	WLKIO150048...
1815	480	1000	603	611	630	581	591	571	557	557	WLKIO181048...

Kioto One



Barva je zahrnuta v ceně

výběr připojení v ceně



SADA OBSAHUJE:

Radiátor se zabudovanou topnou tyčí One. Funkce topné tyče ONE: Stránka 287.

DOPORUČUJEME PRO PŘIPOJENÍ S1 i S8:



Integrovaná sada termostatická s ponornou trubicí, Chrom

 WRZT5G5-CR: 151 EUR

 WRZT5G6-CR: 151 EUR

Stránka: 334



Sada krycí integrovaná, Chrom

TGPCR002: 38 EUR

Stránka: 374



Regulátor TTIR1

TGRTBI001: 104 EUR

Stránka: 304



RADIÁTOR VODNĚ-ELEKTRICKÝ (CENA VČETNĚ ZABUDOVANÉ TOPNÉ TYČE ONE)

Připojení:



Vyber druh kabelu:



A ↕ [mm]	B ↔ [mm]	75/65/20°C [W]	55/45/20°C [W]	 [W]	Barvy RAL a speciální barvy Cena bez DPH [EUR]	Kód produktu ... Kód konfigurace s. 386
870	480	476	255	400	462	WZKIN087048...
1185	480	628	336	600	510	WZKIN118048...
1500	480	780	415	800	558	WZKIN150048...
1815	480	932	496	1000	606	WZKIN181048...

Kioto One E



Barva je zahrnuta v ceně



výběr připojení v ceně



TŘÍDA I



45-60°C/2



P-W-U



120-1000W



IR



IPx5



2h/1



RADIÁTOR ELEKTRICKÝ (CENA VČETNĚ NÁPLNĚ A ZABUDOVANÉ TOPNÉ TYČE ONE)

Připojení:



Vyber druh kabelu:



A ↕ [mm]	B ↔ [mm]	Výkon [W]	Barvy RAL a speciální barvy Cena bez DPH [EUR]	Kód produktu ... Kód konfigurace s. 387
870	480	400	480	WWKIN087048...
1185	480	600	528	WWKIN118048...
1500	480	800	576	WWKIN150048...
1815	480	1000	624	WWKIN181048...

Lena



Barva je zahrnuta v ceně

výběr připojení v ceně

DOPORUČUJEME PRO PŘIPOJENÍ Z1 i Z8:



Integrovaná sada termostatická, Chrom

WRZT5G1-CR: 145 EUR
 WRZT5G2-CR: 145 EUR

Stránka: 332



Sada krycí integrovaná, Chrom

TGPCR002: 38 EUR

Stránka: 374



Háček bodový YO!

WRWYOY001*: 4 EUR

Stránka: 316



Topná tyč MOA, Chrom

WEMOA*: 105 EUR

Stránka: 295



RADIÁTOR VODNÍ / VODNĚ-ELEKTRICKÝ (DOKOUPIT TOPNOU TYČ)

Připojení:

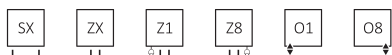

A ↕ [mm]	B ↔ [mm]	Barva ze vzorníku RAL a speciálních barev			Galvanický povrch Chrom			Barvy RAL a speciální barvy Cena bez DPH [EUR]	Chrom Cena bez DPH [EUR]	Kód produktu ... Kód konfigurace s. 385
		75/65/20°C [W]	55/45/20°C [W]	[W]	75/65/20°C [W]	55/45/20°C [W]	[W]			
660	400	243	131	300	170	92	200	189	376	WGLEN066040...
660	436	262	141	300	183	99	200	193	387	WGLEN066043...
660	486	287	154	300	201	108	200	196	399	WGLEN066048...
660	500	294	158	300	206	111	200	198	403	WGLEN066050...
660	536	312	168	300	218	118	200	201	414	WGLEN066053...
660	586	337	181	400	236	127	200	205	431	WGLEN066058...
660	600	343	185	400	240	130	200	206	435	WGLEN066060...
660	636	361	194	400	253	136	300	209	445	WGLEN066063...
660	686	385	207	400	270	145	300	212	458	WGLEN066068...
900	400	326	175	300	228	123	200	207	434	WGLEN090040...
900	436	351	189	400	246	132	300	210	446	WGLEN090043...
900	486	385	207	400	270	145	300	215	463	WGLEN090048...
900	500	394	212	400	276	148	300	216	471	WGLEN090050...
900	536	418	225	400	293	158	300	220	483	WGLEN090053...
900	586	451	242	400	316	169	300	225	514	WGLEN090058...
900	600	460	247	400	322	173	300	226	518	WGLEN090060...
900	636	484	260	600	339	182	400	231	533	WGLEN090063...
900	686	516	277	600	361	194	400	236	549	WGLEN090068...
1140	400	409	219	400	286	153	300	227	515	WGLEN114040...
1140	436	440	236	400	308	165	300	230	531	WGLEN114043...
1140	486	483	259	600	338	181	400	234	553	WGLEN114048...
1140	500	495	265	600	347	186	400	237	559	WGLEN114050...

Lena

A ⇕ [mm]	B ↔ [mm]	Barva ze vzorníku RAL a speciálních barev			Galvanický povrch Chrom			Barvy RAL a speciální barvy Cena bez DPH [EUR]	Chrom Cena bez DPH [EUR]	Kód produktu ... Kód konfigurace s. 385
		75/65/20°C [W]	55/45/20°C [W]	☉ [W]	75/65/20°C [W]	55/45/20°C [W]	☉ [W]			
1140	536	525	281	600	368	197	400	241	575	WGLEN114053...
1140	586	566	303	600	396	212	400	248	605	WGLEN114058...
1140	600	578	310	600	405	217	400	249	611	WGLEN114060...
1140	636	607	325	600	425	228	400	255	629	WGLEN114063...
1140	686	648	347	600	454	243	400	261	653	WGLEN114068...
1380	400	493	264	600	345	185	400	244	576	WGLEN138040...
1380	436	530	284	600	371	199	400	248	593	WGLEN138043...
1380	486	582	311	600	407	218	400	255	619	WGLEN138048...
1380	500	596	319	600	417	223	400	257	628	WGLEN138050...
1380	536	632	338	600	442	237	400	264	649	WGLEN138053...
1380	586	682	365	800	477	256	400	271	693	WGLEN138058...
1380	600	696	372	800	487	260	600	273	699	WGLEN138060...
1380	636	731	391	800	512	274	600	279	720	WGLEN138063...
1380	686	780	417	800	546	292	600	286	746	WGLEN138068...
1620	400	577	308	600	404	216	400	263	641	WGLEN162040...
1620	436	621	332	600	435	232	400	268	665	WGLEN162043...
1620	486	682	364	800	477	255	400	276	694	WGLEN162048...
1620	500	698	373	800	489	261	600	279	704	WGLEN162050...
1620	536	741	396	800	519	277	600	282	725	WGLEN162053...
1620	586	799	427	800	559	299	600	290	775	WGLEN162058...
1620	600	815	435	800	571	305	600	292	782	WGLEN162060...
1620	636	857	457	800	600	320	600	300	806	WGLEN162063...
1620	686	914	488	1000	640	342	600	308	839	WGLEN162068...
1860	400	663	354	600	–	–	–	277	–	WGLEN186040...
1860	436	714	381	800	–	–	–	284	–	WGLEN186043...
1860	486	783	417	800	–	–	–	293	–	WGLEN186048...
1860	500	802	427	800	–	–	–	296	–	WGLEN186050...
1860	536	851	453	800	–	–	–	302	–	WGLEN186053...
1860	586	918	489	1000	–	–	–	312	–	WGLEN186058...
1860	600	937	499	1000	–	–	–	316	–	WGLEN186060...
1860	636	984	524	1000	–	–	–	322	–	WGLEN186063...
1860	686	1050	559	1000	–	–	–	332	–	WGLEN186068...

Lena E



Barva je zahrnuta v ceně



výběr připojení v ceně

RADIÁTOR ELEKTRICKÝ (CENA VČETNĚ NÁPLNĚ A ZVOLENÉ TOPNÉ TYČE)

Připojení:



A ↓ [mm]	B ↔ [mm]	Výkon [W]		MEG Cena bez DPH [EUR]		MOA/DRY/TDY Cena bez DPH [EUR] (MOA IR: +12 EUR) (MOA BLUE: +38 EUR)		ONE Cena bez DPH [EUR] (Nezabudovaná, v 8cm profilu v barvě radiátoru)		REG 2 Cena bez DPH [EUR]		REG 3 Cena bez DPH [EUR]		SIM Cena bez DPH [EUR]		Terma Split třída I Cena bez DPH [EUR] (nezapomeňte si koupit regulátor KTX)		Smart Split třída I Cena bez DPH [EUR] (nezapomeňte si koupit SMART Wi-Fi regulátor VEO)		Kód produktu ... Kód konfigurace s. 388
				Barva	Chrom	Barvy RAL a speciální barvy	Chrom	Barvy RAL a speciální barvy	Chrom	Barvy RAL a speciální barvy	Chrom	Barvy RAL a speciální barvy	Chrom	Barvy RAL a speciální barvy	Chrom	Barvy RAL a speciální barvy	Chrom	Barvy RAL a speciální barvy	Chrom	
660	400	300	200	285	471	292	478	312	498	263	448	273	458	253	439	238	424	238	424	WLEEN066040...
660	436	300	200	289	482	296	489	316	509	266	459	276	469	257	450	242	435	242	435	WLEEN066043...
660	486	300	200	291	494	298	501	318	521	269	472	279	482	259	462	244	447	244	447	WLEEN066048...
660	500	300	200	292	498	300	505	319	525	270	475	280	485	260	466	246	451	246	451	WLEEN066050...
660	536	300	200	296	509	303	516	323	536	274	487	284	496	264	477	249	462	249	462	WLEEN066053...
660	586	400	200	300	526	307	533	327	553	277	504	287	514	268	494	253	479	253	479	WLEEN066058...
660	600	400	200	301	530	308	537	328	557	279	507	289	517	269	498	254	483	254	483	WLEEN066060...
660	636	400	300	303	539	311	547	330	566	281	517	291	527	271	507	257	493	257	493	WLEEN066063...
660	686	400	300	307	553	314	560	334	580	285	531	295	541	275	521	260	506	260	506	WLEEN066068...
900	400	300	200	302	528	309	536	329	555	280	506	290	516	270	496	255	482	255	482	WLEEN090040...
900	436	400	300	305	541	312	548	332	568	282	518	292	528	273	509	258	494	258	494	WLEEN090043...
900	486	400	300	309	558	317	565	336	585	287	536	297	546	277	526	263	511	263	511	WLEEN090048...
900	500	400	300	312	565	319	573	339	592	290	543	300	553	280	533	265	518	265	518	WLEEN090050...
900	536	400	300	314	577	322	585	341	605	292	555	302	565	282	546	268	531	268	531	WLEEN090053...
900	586	400	300	319	609	327	617	346	637	297	587	307	597	287	577	273	563	273	563	WLEEN090058...
900	600	400	300	321	613	328	621	348	640	298	591	308	601	289	581	274	566	274	566	WLEEN090060...
900	636	600	400	325	628	333	635	352	655	303	606	313	616	293	596	279	581	279	581	WLEEN090063...
900	686	600	400	330	645	338	653	357	672	308	623	318	633	298	613	284	598	284	598	WLEEN090068...
1140	400	400	300	322	609	329	617	349	637	300	587	309	597	290	577	275	563	275	563	WLEEN114040...
1140	436	400	300	324	625	332	633	351	653	302	603	312	613	292	593	277	579	277	579	WLEEN114043...
1140	486	600	400	329	648	336	655	356	675	307	625	317	635	297	616	282	601	282	601	WLEEN114048...
1140	500	600	400	332	654	339	661	359	681	309	632	319	641	300	622	285	607	285	607	WLEEN114050...
1140	536	600	400	335	671	343	678	362	698	313	649	323	659	303	639	289	624	289	624	WLEEN114053...
1140	586	600	400	343	699	350	707	370	726	321	677	330	687	311	667	296	653	296	653	WLEEN114058...
1140	600	600	400	344	705	351	713	371	732	322	683	332	693	312	673	297	659	297	659	WLEEN114060...

Lena E

A ↕ [mm]	B ↔ [mm]	Výkon [W]		MEG Cena bez DPH [EUR]		MOA/DRY/TDY Cena bez DPH [EUR] (MOAIR: +12 EUR) (MOABLUE: +38 EUR)		ONE Cena bez DPH [EUR] (Nezabudovaná, v8cm profilu v barvě radiátoru)		REG 2 Cena bez DPH [EUR]		REG 3 Cena bez DPH [EUR]		SIM Cena bez DPH [EUR]		Terma Split třída I Cena bez DPH [EUR] (nezapomeňte si koupit regulátor KTX)		Smart Split třída I Cena bez DPH [EUR] (nezapomeňte si koupit SMART Wi-Fi regulátor VEO)		Kód produktu ... Kód konfigurace s. 388
		Barva	Chrom	Barvy RAL a speciální barvy	Chrom	Barvy RAL a speciální barvy	Chrom	Barvy RAL a speciální barvy	Chrom	Barvy RAL a speciální barvy	Chrom	Barvy RAL a speciální barvy	Chrom	Barvy RAL a speciální barvy	Chrom	Barvy RAL a speciální barvy	Chrom	Barvy RAL a speciální barvy	Chrom	
1140	636	600	400	350	724	357	731	377	751	328	702	338	712	318	692	303	677	303	677	WLLN114063...
1140	686	600	400	356	747	364	755	383	774	334	725	344	735	324	715	309	700	309	700	WLLN114068...
1380	400	600	400	339	671	346	678	366	698	317	649	327	659	307	639	292	624	292	624	WLLN138040...
1380	436	600	400	343	688	350	696	370	715	321	666	330	676	311	656	296	641	296	641	WLLN138043...
1380	486	600	400	350	715	357	723	377	742	328	693	338	703	318	683	303	668	303	668	WLLN138048...
1380	500	600	400	351	723	359	730	378	750	329	700	339	710	319	691	305	676	305	676	WLLN138050...
1380	536	600	400	359	743	366	751	386	771	336	721	346	731	327	712	312	697	312	697	WLLN138053...
1380	586	800	400	366	788	373	795	393	815	344	766	354	775	334	756	319	741	319	741	WLLN138058...
1380	600	800	600	367	794	375	801	394	821	345	772	355	782	335	762	321	747	321	747	WLLN138060...
1380	636	800	600	373	815	381	822	400	842	351	793	361	803	341	783	327	768	327	768	WLLN138063...
1380	686	800	600	381	842	388	849	408	869	359	820	368	830	349	810	334	795	334	795	WLLN138068...
1620	400	600	400	357	737	365	745	384	764	335	715	345	725	325	705	311	691	311	691	WLLN162040...
1620	436	600	400	362	759	370	767	389	787	340	737	350	747	330	728	316	713	316	713	WLLN162043...
1620	486	800	400	371	789	378	796	398	816	349	767	359	777	339	757	324	742	324	742	WLLN162048...
1620	500	800	600	373	800	381	807	400	827	351	778	361	788	341	768	327	753	327	753	WLLN162050...
1620	536	800	600	377	820	384	827	404	847	355	798	365	807	345	788	330	773	330	773	WLLN162053...
1620	586	800	600	384	870	392	878	412	897	362	848	372	858	352	838	338	823	338	823	WLLN162058...
1620	600	800	600	387	878	394	885	414	905	365	855	375	865	355	846	340	831	340	831	WLLN162060...
1620	636	800	600	394	902	402	909	421	929	372	880	382	890	362	870	348	855	348	855	WLLN162063...
1620	686	1000	600	403	935	410	943	430	962	381	913	391	923	371	903	356	889	356	889	WLLN162068...
1860	400	600	-	372	-	380	-	399	-	350	-	360	-	340	-	325	-	325	-	WLLN186040...
1860	436	800	-	378	-	386	-	405	-	356	-	366	-	346	-	332	-	332	-	WLLN186043...
1860	486	800	-	388	-	396	-	415	-	366	-	376	-	356	-	341	-	341	-	WLLN186048...
1860	500	800	-	391	-	398	-	418	-	368	-	378	-	359	-	344	-	344	-	WLLN186050...
1860	536	800	-	397	-	404	-	424	-	375	-	384	-	365	-	350	-	350	-	WLLN186053...
1860	586	1000	-	408	-	415	-	435	-	386	-	396	-	376	-	361	-	361	-	WLLN186058...
1860	600	1000	-	410	-	418	-	437	-	388	-	398	-	378	-	364	-	364	-	WLLN186060...
1860	636	1000	-	416	-	424	-	443	-	394	-	404	-	384	-	370	-	370	-	WLLN186063...
1860	686	1000	-	426	-	434	-	453	-	404	-	414	-	394	-	380	-	380	-	WLLN186068...

Lima



DOPORUČUJEME PRO PŘIPOJENÍ SX:



Sada tříosová termostatická, Chrom

WRZTCG1-CR: 143EUR

WRZTCG2-CR: 143EUR

Stránka: 330



Sada krycí dvojitá, Chrom

TGPCR001: 27EUR

Stránka: 373



Háček bodový YO!

WRWYOY001*: 4EUR

Stránka: 316

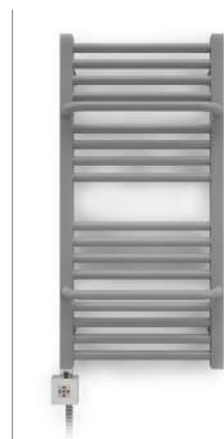

RADIÁTOR VODNÍ / VODNĚ-ELEKTRICKÝ (DOKOUPIT TOPNOU TYČ)

Připojení:

Výška [mm] 300÷1700:

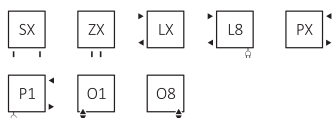

Výška [mm] 500÷1700:

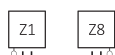



Výška [mm] 820÷1700:



A ↓ [mm]	B ↔ [mm]	Barva ze vzorníku RAL a speciálních barev			Galvanický povrch Chrom			Barvy RAL a speciální barvy Cena bez DPH [EUR]	Chrom Cena bez DPH [EUR]	Kód produktu ... Kód konfigurace s.385
		75/65/20°C [W]	55/45/20°C [W]	☺ [W]	75/65/20°C [W]	55/45/20°C [W]	☺ [W]			
300	1000	290	159	–	203	104	–	198	436	WGLIM030100...
300	1200	347	191	–	243	124	–	209	451	WGLIM030120...
300	1400	405	223	–	284	145	–	217	482	WGLIM030140...
500	300	144	79	120	101	51	120	161	407	WGLIM050030...
500	400	192	105	200	134	69	120	166	421	WGLIM050040...
500	500	241	131	200	169	86	200	174	436	WGLIM050050...
500	600	282	153	300	197	101	200	186	467	WGLIM050060...
500	700	324	176	300	227	116	200	189	482	WGLIM050070...
500	1000	482	262	–	337	172	–	202	496	WGLIM050100...
500	1200	578	314	–	405	206	–	217	542	WGLIM050120...
500	1400	675	367	–	473	241	–	232	586	WGLIM050140...
820	300	244	132	300	171	87	200	186	467	WGLIM082030...
820	400	325	175	300	228	116	200	194	482	WGLIM082040...
820	500	406	218	400	284	145	300	202	496	WGLIM082050...
820	600	477	256	400	334	170	400	215	511	WGLIM082060...
820	700	547	293	600	383	195	400	232	542	WGLIM082070...
1140	300	345	185	400	242	123	300	217	511	WGLIM114030...
1140	400	460	247	400	322	164	300	228	526	WGLIM114040...
1140	500	574	308	600	402	205	400	246	542	WGLIM114050...
1140	600	675	361	800	473	241	400	260	571	WGLIM114060...

Lima

A ⇕ [mm]	B ↔ [mm]	Barva ze vzorníku RAL a speciálních barev			Galvanický povrch Chrom			Barvy RAL a speciální barvy <small>Cena bez DPH [EUR]</small>	Chrom <small>Cena bez DPH [EUR]</small>	Kód produktu <small>... Kód konfigurace s. 385</small>
		75/65/20°C [W]	55/45/20°C [W]	 [W]	75/65/20°C [W]	55/45/20°C [W]	 [W]			
1140	700	776	415	800	543	277	600	276	617	WGLIM114070...
1460	300	449	240	400	314	160	300	232	571	WGLIM146030...
1460	400	599	319	600	419	214	400	246	586	WGLIM146040...
1460	500	748	399	800	524	267	600	260	601	WGLIM146050...
1460	600	879	468	800	615	314	600	274	632	WGLIM146060...
1460	700	1009	537	1000	706	360	800	306	661	WGLIM146070...
1700	300	527	280	600	369	188	400	274	617	WGLIM170030...
1700	400	703	374	800	492	251	600	289	632	WGLIM170040...
1700	500	878	466	800	615	313	600	302	661	WGLIM170050...
1700	600	1031	547	1000	722	368	800	328	721	WGLIM170060...
1700	700	1183	628	1200	828	422	800	359	782	WGLIM170070...

Lima E



Barva je zahrnuta v ceně



výběr připojení v ceně

RADIÁTOR ELEKTRICKÝ (CENA VČETNĚ NÁPLNĚ A ZVOLENÉ TOPNÉ TYČE)



A ↕ [mm]	B ↔ [mm]	Výkon [W]		MEG		MOA/DRY/TDY		ONE		REG 2		REG 3		SIM		Terma Split třída I		Smart Split třída I		Kód produktu ... Kód konfigurace s. 388
				Cena bez DPH [EUR]		Cena bez DPH [EUR]		Cena bez DPH [EUR]		Cena bez DPH [EUR]		Cena bez DPH [EUR]		Cena bez DPH [EUR]		Cena bez DPH [EUR]		Cena bez DPH [EUR]		
		Barva	Chrom	Barvy RAL a speciální barvy	Chrom	Barvy RAL a speciální barvy	Chrom	Barvy RAL a speciální barvy	Chrom	Barvy RAL a speciální barvy	Chrom	Barvy RAL a speciální barvy	Chrom	Barvy RAL a speciální barvy	Chrom	Barvy RAL a speciální barvy	Chrom	Barvy RAL a speciální barvy	Chrom	
500	300	120	120	255	501	263	509	282	528	233	479	243	489	223	469	209	455	209	455	WLLIM050030...
500	400	200	120	260	516	268	523	287	543	238	494	248	504	228	484	214	469	214	469	WLLIM050040...
500	500	200	200	269	531	276	538	296	558	247	509	257	518	237	499	222	484	222	484	WLLIM050050...
500	600	300	200	281	562	289	569	308	589	259	539	269	549	249	530	234	515	234	515	WLLIM050060...
500	700	300	200	284	576	291	584	311	603	261	554	271	564	252	544	237	530	237	530	WLLIM050070...
820	300	300	200	281	562	289	569	308	589	259	539	269	549	249	530	234	515	234	515	WLLIM082030...
820	400	300	200	289	576	296	584	316	603	266	554	276	564	257	544	242	530	242	530	WLLIM082040...
820	500	400	300	297	591	305	598	324	618	275	569	285	579	265	559	250	544	250	544	WLLIM082050...
820	600	400	400	309	606	317	613	336	633	287	584	297	593	277	574	263	559	263	559	WLLIM082060...
820	700	600	400	325	637	333	644	352	664	303	614	313	624	293	605	279	590	279	590	WLLIM082070...
1140	300	400	300	312	606	319	613	339	633	290	584	300	593	280	574	265	559	265	559	WLLIM114030...
1140	400	400	300	323	621	330	628	350	648	301	598	311	608	291	589	276	574	276	574	WLLIM114040...
1140	500	600	400	340	637	348	644	367	664	318	614	328	624	308	605	293	590	293	590	WLLIM114050...
1140	600	800	400	355	666	362	673	382	693	333	644	343	654	323	634	308	619	308	619	WLLIM114060...
1140	700	800	600	371	712	378	719	398	739	349	689	359	699	339	680	324	665	324	665	WLLIM114070...
1460	300	400	300	325	666	333	673	352	693	303	644	313	654	293	634	279	619	279	619	WLLIM146030...
1460	400	600	400	340	681	348	688	367	708	318	659	328	668	308	649	293	634	293	634	WLLIM146040...
1460	500	800	600	355	696	362	703	382	723	333	673	343	683	323	664	308	649	308	649	WLLIM146050...
1460	600	800	600	368	726	376	734	396	753	346	704	356	714	336	694	322	680	322	680	WLLIM146060...
1460	700	1000	800	399	756	407	763	426	783	377	734	387	743	367	724	352	709	352	709	WLLIM146070...
1700	300	600	400	368	712	376	719	396	739	346	689	356	699	336	680	322	665	322	665	WLLIM170030...
1700	400	800	600	383	726	391	734	410	753	361	704	371	714	351	694	336	680	336	680	WLLIM170040...
1700	500	800	600	397	756	404	763	424	783	375	734	384	743	365	724	350	709	350	709	WLLIM170050...
1700	600	1000	800	423	816	430	823	450	843	400	794	410	804	391	784	376	769	376	769	WLLIM170060...
1700	700	1200	800	453	876	461	884	480	903	431	854	441	864	421	844	407	830	407	830	WLLIM170070...

Lima One



Barva je zahrnuta v ceně



výběr připojení v ceně



TŘÍDA I



45-60°C/2



P-W-U



120-1000W



IR



IPx5



2h/1



SADA OBSAHUJE:

Radiátor se zabudovanou topnou tyčí One. Funkce topné tyče ONE: Stránka 287.

DOPORUČUJEME PRO PŘIPOJENÍ S1 i S8:



Integrovaná sada termostatická s ponornou trubicí, Chrom

WRZT5G5-CR: 151EUR

WRZT5G6-CR: 151EUR

Stránka: 334



Sada krycí integrovaná, Chrom

TGPCR002: 38EUR

Stránka: 374



Háček bodový YO!

WRWYOY001*: 4EUR

Stránka: 316



RADIÁTOR VODNĚ-ELEKTRICKÝ (CENA VČETNĚ ZABUDOVANÉ TOPNÉ TYČE ONE)

Připojení:

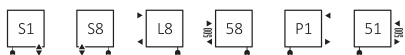

Vyber druh kabelu:

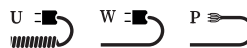

A ↓ [mm]	B ↔ [mm]	Barva ze vzorníku RAL a speciálních barev			Galvanický povrch Chrom			Barvy RAL a speciální barvy Cena bez DPH [EUR]	Chrom Cena bez DPH [EUR]	Kód produktu ... Kód konfigurace s. 386
		75/65/20°C [W]	55/45/20°C [W]	[W]	75/65/20°C [W]	55/45/20°C [W]	[W]			
820	300	244	132	300	171	87	200	284	564	WZLIE082030...
820	400	325	175	300	228	116	200	291	579	WZLIE082040...
820	500	406	218	400	284	145	200	300	593	WZLIE082050...
820	600	477	256	400	334	170	300	312	608	WZLIE082060...
820	700	547	293	600	383	195	300	328	639	WZLIE082070...
1140	300	345	185	400	242	123	200	314	608	WZLIE114030...
1140	400	460	247	400	322	164	300	325	623	WZLIE114040...
1140	500	574	308	600	402	205	400	343	639	WZLIE114050...
1140	600	675	361	800	473	241	400	357	668	WZLIE114060...
1140	700	776	415	800	543	277	500	373	714	WZLIE114070...
1460	300	449	240	400	314	160	300	328	668	WZLIE146030...
1460	400	599	319	600	419	214	400	343	683	WZLIE146040...
1460	500	748	399	800	524	267	500	357	698	WZLIE146050...
1460	600	879	468	800	615	314	600	371	729	WZLIE146060...
1460	700	1009	537	1000	706	360	700	402	758	WZLIE146070...
1700	300	527	280	600	369	188	300	371	714	WZLIE170030...
1700	400	703	374	800	492	251	400	386	729	WZLIE170040...
1700	500	878	466	800	615	313	600	399	758	WZLIE170050...
1700	600	1031	547	1000	722	368	700	425	819	WZLIE170060...
1700	700	-	-	-	828	422	800	-	879	WZLIE170070...

Lima One E



Barva je zahrnuta v ceně



výběr připojení v ceně



RADIÁTOR ELEKTRICKÝ (CENA VČETNĚ NÁPLNĚ A ZABUDOVANÉ TOPNÉ TYČE ONE)

Připojení:



A ↕ [mm]	B ↔ [mm]	Výkon [W]		Barvy RAL a speciální barvy Cena bez DPH [EUR]	Chrom Cena bez DPH [EUR]	Kód produktu ... Kód konfigurace s.387
		Barva	Chrom			
820	300	300	200	302	582	WWLIE082030...
820	400	300	200	309	597	WWLIE082040...
820	500	400	300	318	612	WWLIE082050...
820	600	400	400	330	627	WWLIE082060...
820	700	600	400	346	657	WWLIE082070...
1140	300	400	300	333	627	WWLIE114030...
1140	400	400	300	344	641	WWLIE114040...
1140	500	600	400	361	657	WWLIE114050...
1140	600	800	400	376	687	WWLIE114060...
1140	700	800	600	392	732	WWLIE114070...
1460	300	400	300	346	687	WWLIE146030...
1460	400	600	400	361	702	WWLIE146040...
1460	500	800	600	376	716	WWLIE146050...
1460	600	800	600	389	747	WWLIE146060...
1460	700	1000	800	420	777	WWLIE146070...
1700	300	600	400	389	732	WWLIE170030...
1700	400	800	600	404	747	WWLIE170040...
1700	500	800	600	418	777	WWLIE170050...
1700	600	1000	800	443	837	WWLIE170060...
1700	700	-	800	-	897	WWLIE170070...

DOPORUČUJEME PRO PŘIPOJENÍ SX:



Sada tříosová termostatická, Chrom
 WRZTCG1-CR: 143EUR
 WRZTCG2-CR: 143EUR
 Stránka: 330



Sada krycí dvojitá, Chrom
 TGPCR001: 27EUR
 Stránka: 373





Háček bodový ZIP H 10, Chrom
 WRWZIP008 KCRO: 42EUR
 Stránka: 316

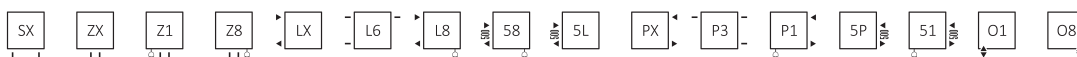

RADIÁTOR VODNÍ / VODNĚ-ELEKTRICKÝ (DOKOUPIT TOPNOU TYČ)

Připojení:



A ↑ [mm]	B ↔ [mm]	75/65/20°C [W]	55/45/20°C [W]	 [W]	Barvy RAL a speciální barvy Cena bez DPH [EUR]	Kód produktu ... Kód konfigurace s. 385
940	400	344	186	400	293	WGW51094040...
940	500	428	231	400	307	WGW51094050...
940	600	502	271	600	319	WGW51094060...
1180	400	435	234	400	316	WGW51118040...
1180	500	538	288	600	333	WGW51118050...
1180	600	629	337	600	349	WGW51118060...
1420	400	526	283	600	338	WGW51142040...
1420	500	633	340	600	357	WGW51142050...
1420	600	756	406	800	378	WGW51142060...
1660	400	617	331	600	359	WGW51166040...
1660	500	758	405	800	383	WGW51166050...
1660	600	883	470	800	407	WGW51166060...

Lukka E



Barva je zahrnuta v ceně



výběr připojení v ceně

RADIÁTOR ELEKTRICKÝ (CENA VČETNĚ NÁPLNĚ A ZVOLENÉ TOPNÉ TYČE)

Připojení:



A ↕ [mm]	B ↔ [mm]	Výkon [W]	MEG Cena bez DPH [EUR]	MOA/DRY/ TDY Cena bez DPH [EUR] (MOA IR: + 12 EUR) (MOA BLUE: + 38 EUR)	ONE Cena bez DPH [EUR] (Nezabudovaná, v 8cm profilu v barvě radiátoru)	REG 2 Cena bez DPH [EUR]	REG 3 Cena bez DPH [EUR]	SIM Cena bez DPH [EUR]	Terma Split třída I Cena bez DPH [EUR] (nezapomeňte si koupit regulátor KTX)	Smart Split třída I Cena bez DPH [EUR] (nezapomeňte si koupit SMART Wi-Fi regulátor VEO)	Kód produktu ... Kód konfigurace s. 388
940	400	400	388	396	415	366	376	356	341	341	WLW51094040...
940	500	400	402	409	429	380	389	370	355	355	WLW51094050...
940	600	600	414	421	441	392	402	382	367	367	WLW51094060...
1180	400	400	410	418	437	388	398	378	364	364	WLW51118040...
1180	500	600	427	435	455	405	415	396	381	381	WLW51118050...
1180	600	600	443	451	471	421	431	412	397	397	WLW51118060...
1420	400	600	432	440	459	410	420	400	386	386	WLW51142040...
1420	500	600	452	459	479	430	440	420	405	405	WLW51142050...
1420	600	800	473	480	500	451	461	441	426	426	WLW51142060...
1660	400	600	453	461	480	431	441	421	407	407	WLW51166040...
1660	500	800	478	485	505	456	466	446	431	431	WLW51166050...
1660	600	800	501	509	528	479	489	469	455	455	WLW51166060...

Marlin



Barva je zahrnuta v ceně

výběr připojení v ceně

DOPORUČUJEME PRO PŘIPOJENÍ SX:



Sada tříosová termostatická, Chrom

WRZTCG1-CR: 143 EUR

WRZTCG2-CR: 143 EUR

Stránka: 330



Sada krycí dvojitá, Chrom

TGPCR001: 27 EUR

Stránka: 373



Háček bodový ZIP H 10, Chrom

WRWZIP008: 42 EUR

Stránka: 316



RADIÁTOR VODNÍ / VODNĚ-ELEKTRICKÝ (DOKOUPIT TOPNOU TYČ)

Připojení:

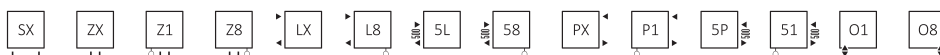

A ↕ [mm]	B ↔ [mm]	Barva ze vzorníku RAL a speciálních barev			Galvanický povrch Chrom			Barvy RAL a speciální barvy Cena bez DPH [EUR]	Chrom Cena bez DPH [EUR]	Kód produktu ... Kód konfigurace s. 385
		75/65/20°C [W]	55/45/20°C [W]	[W]	75/65/20°C [W]	55/45/20°C [W]	[W]			
600	430	244	134	300	156	84	120	207	373	WGMAR060043...
600	530	301	165	300	192	104	200	217	396	WGMAR060053...
600	630	358	196	400	228	124	200	228	415	WGMAR060063...
780	430	319	172	300	211	112	200	228	415	WGMAR078043...
780	530	393	212	400	260	137	300	238	440	WGMAR078053...
780	630	467	252	400	310	163	300	252	468	WGMAR078063...
1185	430	467	251	400	323	162	300	275	538	WGMAR118043...
1185	530	576	309	600	398	199	400	286	573	WGMAR118053...
1185	630	685	367	800	473	237	600	298	607	WGMAR118063...
1680	430	653	351	600	462	217	600	359	670	WGMAR168043...
1680	530	805	433	800	570	267	600	377	721	WGMAR168053...
1680	630	957	514	1000	677	317	800	397	774	WGMAR168063...

Marlin E



Barva je zahrnuta v ceně



výběr připojení v ceně

RADIÁTOR ELEKTRICKÝ (CENA VČETNĚ NÁPLNĚ A ZVOLENÉ TOPNÉ TYČE)

Připojení:



A ↓ [mm]	B ↔ [mm]	Výkon [W]		MEG		MOA/DRY/TDY		ONE		REG 2		REG 3		SIM		Terma Split třída I		Smart Split třída I		Kód produktu ... Kód konfigurace s. 388
				Cena bez DPH [EUR]		Cena bez DPH [EUR] (MOAIR: +12 EUR) (MOABLU: +38 EUR)		Cena bez DPH [EUR] (Nezabudovaná, v 8cm profilu v barvě radiátoru)		Cena bez DPH [EUR]		Cena bez DPH [EUR]		Cena bez DPH [EUR]		Cena bez DPH [EUR] (nezapomeňte si koupit regulátor KTX)		Cena bez DPH [EUR] (nezapomeňte si koupit SMART Wi-Fi regulátor VEO)		
		Barva	Chrom	Barva RAL a speciální barvy	Chrom	Barva RAL a speciální barvy	Chrom	Barva RAL a speciální barvy	Chrom	Barva RAL a speciální barvy	Chrom	Barva RAL a speciální barvy	Chrom	Barva RAL a speciální barvy	Chrom	Barva RAL a speciální barvy	Chrom	Barva RAL a speciální barvy	Chrom	
600	430	300	120	302	468	309	475	329	495	280	446	290	456	270	436	255	421	255	421	WLMAR060043...
600	530	300	200	312	489	319	496	339	516	290	467	300	477	280	457	265	442	265	442	WLMAR060053...
600	630	400	200	323	510	330	517	350	537	301	488	311	498	291	478	276	463	276	463	WLMAR060063...
780	430	300	200	323	510	330	517	350	537	301	488	311	498	291	478	276	463	276	463	WLMAR078043...
780	530	400	300	333	534	340	542	360	562	311	512	321	522	301	502	286	488	286	488	WLMAR078053...
780	630	400	300	346	563	354	570	373	590	324	541	334	550	314	531	300	516	300	516	WLMAR078063...
1185	430	400	300	370	633	377	640	397	660	348	611	357	621	338	601	323	586	323	586	WLMAR118043...
1185	530	600	400	381	667	388	675	408	694	359	645	368	655	349	635	334	621	334	621	WLMAR118053...
1185	630	800	600	392	702	399	709	419	729	370	680	380	689	360	670	345	655	345	655	WLMAR118063...
1680	430	600	600	452	764	459	772	479	791	430	742	440	752	420	732	405	718	405	718	WLMAR168043...
1680	530	800	600	472	816	479	823	499	843	450	794	459	804	440	784	425	769	425	769	WLMAR168053...
1680	630	1000	800	491	869	499	876	518	896	469	847	479	857	459	837	445	822	445	822	WLMAR168063...

Marlin One



Barva je zahrnuta v ceně

výběr připojení v ceně

TŘÍDA I

45-60°C/2

P-W-U

120-1000W

IR

IPx5

2h/1

IR

IR

SADA OBSAHUJE:

Radiátor se zabudovanou topnou tyčí One. Funkce topné tyče ONE: Stránka 287.

DOPORUČUJEME PRO PŘIPOJENÍ S1 i S8:



Integrovaná sada termostatická s ponornou trubicí, Chrom

WRZT5G5-CR: 151EUR

WRZT5G6-CR: 151EUR

Stránka: 334



Sada krycí integrovaná, Chrom

TGPCR002: 38EUR

Stránka: 374



Regulátor TTIR1

TGRTBI001: 104EUR

Stránka: 304



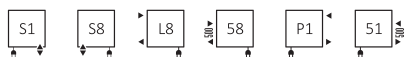

RADIÁTOR VODNĚ-ELEKTRICKÝ (CENA VČETNĚ ZABUDOVANÉ TOPNÉ TYČE ONE)

Připojení:

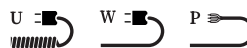

Vyber druh kabelu:



A ↕ [mm]	B ↔ [mm]	Barva ze vzorníku RAL a speciálních barev			Galvanický povrch Chrom			Barvy RAL a speciální barvy (Cena bez DPH [EUR])	Chrom (Cena bez DPH [EUR])	Kód produktu ... Kód konfigurace s.386
		75/65/20°C [W]	55/45/20°C [W]	 [W]	75/65/20°C [W]	55/45/20°C [W]	 [W]			
600	430	245	134	300	156	84	120	305	471	WZMRN060043..
600	530	301	165	300	192	104	200	314	491	WZMRN060053..
600	630	358	196	400	228	124	200	325	512	WZMRN060063..
780	430	319	172	300	211	112	200	325	512	WZMRN078043..
780	530	393	212	400	260	137	300	335	537	WZMRN078053...
780	630	467	252	400	310	163	300	349	565	WZMRN078063...
1185	430	467	251	400	323	162	300	372	635	WZMRN118043...
1185	530	576	309	600	398	199	400	383	670	WZMRN118053...
1185	630	685	367	800	473	237	600	394	704	WZMRN118063...
1680	430	653	351	600	462	217	600	455	767	WZMRN168043...
1680	530	805	433	800	570	267	600	474	819	WZMRN168053...
1680	630	957	514	1000	677	317	800	494	871	WZMRN168063...

Marlin One E



Barva je zahrnuta v ceně



výběr připojení v ceně



RADIÁTOR ELEKTRICKÝ (CENA VČETNĚ NÁPLNĚ A ZABUDOVANÉ TOPNÉ TYČE ONE)

Připojení:



A ↕ [mm]	B ↔ [mm]	Výkon [W]		Barvy RAL a speciální barvy Cena bez DPH [EUR]	Chrom Cena bez DPH [EUR]	Kód produktu ... Kód konfigurace s. 387
		Barva	Chrom			
600	430	300	120	323	489	WWMRN060043...
600	530	300	200	333	510	WWMRN060053...
600	630	400	200	344	531	WWMRN060063...
780	430	300	200	344	531	WWMRN078043...
780	530	400	300	354	555	WWMRN078053...
780	630	400	300	367	584	WWMRN078063...
1185	430	400	300	391	654	WWMRN118043...
1185	530	600	400	402	688	WWMRN118053...
1185	630	800	600	413	723	WWMRN118063...
1680	430	600	600	473	785	WWMRN168043...
1680	530	800	600	493	837	WWMRN168053...
1680	630	1000	800	512	890	WWMRN168063...

Michelle



Barva je zahrnuta v ceně

výběr připojení v ceně

DOPORUČUJEME PRO PŘIPOJENÍ YL i YP:



Sada komplexní integrovaný ventil s T- kusem s možností připojení topné tyče skrze ventil, Chrom

WRZT5G14-CR: 188EUR

WRZT5G15-CR: 188EUR

Stránka: 333



Sada krycí integrovaná, Chrom

TGPCR002: 38EUR

Stránka: 374



RADIÁTOR VODNÍ / VODNĚ-ELEKTRICKÝ (DOKOUPIT TOPNOU TYČ)

Připojení:



RADIÁTOR SE SKLÁDÁ ZE 2 ČÁSTÍ

1. ČÁST – RADIÁTOR (SPIRÁLY)

A ↓ [mm]	B ↔ [mm]	Barva ze vzorníku RAL a speciálních barev			Galvanický povrch Chrom			Barvy RAL a speciální barvy Cena bez DPH [EUR]	Chrom Cena bez DPH [EUR]	Kód produktu ... Kód konfigurace s. 385
		75/65/20°C [W]	55/45/20°C [W]	[W]	75/65/20°C [W]	55/45/20°C [W]	[W]			
780	400	365	196	400	256	130	300	329	722	WGMIC078040...
780	500	455	244	400	319	162	300	348	787	WGMIC078050...
780	600	533	286	600	373	190	400	363	851	WGMIC078060...
1200	400	580	310	600	406	207	400	428	976	WGMIC120040...
1200	500	721	386	800	505	257	600	451	1 081	WGMIC120050...
1200	600	845	452	800	592	302	600	476	1 178	WGMIC120060...
1620	400	805	429	800	564	287	600	516	1 223	WGMIC162040...
1620	500	1000	533	1000	700	357	800	560	1 372	WGMIC162050...
1620	600	1172	624	1200	820	418	800	710	1 510	WGMIC162060...

2. ČÁST - SLOUP (KRYTÍ STOUPAČKOVÝCH PROFILŮ)

A ⇅ [mm]	B ↔ [mm]	Sloup (krytí stoupačkových profilů)			
		Barvy RAL a speciální barvy Cena bez DPH [EUR]	Chrom Cena bez DPH [EUR]	Kód produktu (verze levá pro YL) ... Kód konfigurace s. 390	Kód produktu (verze pravá pro YP) ... Kód konfigurace s. 390
780	400	59	115	WRCMIC078L...	WRCMIC078P...
780	500	59	115	WRCMIC078L...	WRCMIC078P...
780	600	59	115	WRCMIC078L...	WRCMIC078P...
1200	400	68	153	WRCMIC120L...	WRCMIC120P...
1200	500	68	153	WRCMIC120L...	WRCMIC120P...
1200	600	68	153	WRCMIC120L...	WRCMIC120P...
1620	400	77	192	WRCMIC162L...	WRCMIC162P...
1620	500	77	192	WRCMIC162L...	WRCMIC162P...
1620	600	77	192	WRCMIC162L...	WRCMIC162P...

Cena se počítá jako pro Ventily a příslušenství. Můžete také objednat ze Stránky 321

Michelle E



Barva je zahrnuta v ceně



výběr připojení v ceně

RADIÁTOR ELEKTRICKÝ (CENA VČETNĚ NÁPLNĚ A ZVOLENÉ TOPNÉ TYČE)

Připojení:

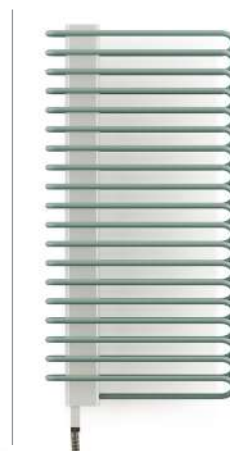

RADIÁTOR SE SKLÁDÁ ZE 2 ČÁSTÍ

1. ČÁST – RADIÁTOR (SPIRÁLY)

A ↕ [mm]	B ↔ [mm]	Výkon [W]		MEG Cena bez DPH [EUR]		MOA/DRY/TDY Cena bez DPH [EUR] (MOAIR: +12 EUR) (MOABLU: +38 EUR)		ONE Cena bez DPH [EUR] (Nezabudovaná, v 8cm profilu v barvě radiátoru)		REG 2 Cena bez DPH [EUR]		REG 3 Cena bez DPH [EUR]		SIM Cena bez DPH [EUR]		Terma Split třída I Cena bez DPH [EUR] (nezapomeňte si koupit regulátor KTX)		Smart Split třída I Cena bez DPH [EUR] (nezapomeňte si koupit SMART Wi-Fi regulátor VEO)		Kód produktu ... Kód konfigurace s. 388
		Barva	Chrom	Barvy RAL a speciální barvy	Chrom	Barvy RAL a speciální barvy	Chrom	Barvy RAL a speciální barvy	Chrom	Barvy RAL a speciální barvy	Chrom	Barvy RAL a speciální barvy	Chrom	Barvy RAL a speciální barvy	Chrom	Barvy RAL a speciální barvy	Chrom	Barvy RAL a speciální barvy	Chrom	
1200	400	600	400	522	1070	529	1077	549	1096	500	1048	509	1057	489	1037	474	1022	474	1022	WLMIC120040...
1200	500	800	600	545	1175	552	1182	572	1202	523	1153	533	1162	513	1143	498	1128	498	1128	WLMIC120050...
1200	600	800	600	569	1272	576	1279	596	1299	547	1250	557	1260	537	1240	522	1225	522	1225	WLMIC120060...
1620	400	800	600	610	1317	617	1324	637	1344	588	1295	597	1304	578	1284	563	1269	563	1269	WLMIC162040...
1620	500	1000	800	654	1466	661	1473	680	1493	632	1444	641	1454	621	1434	606	1419	606	1419	WLMIC162050...
1620	600	1200	800	803	1604	810	1611	830	1630	781	1582	791	1591	771	1571	756	1556	756	1556	WLMIC162060...

2. ČÁST - SLOUP (KRYTÍ STOUPAČKOVÝCH PROFILŮ)

A ↕ [mm]	B ↔ [mm]	Sloup (krytí stoupačkových profilů)			
		Barvy RAL a speciální barvy Cena bez DPH [EUR]	Chrom Cena bez DPH [EUR]	Kód produktu (verze levá pro E1) ... Kód konfigurace s. 390	Kód produktu (verze pravá pro E8) ... Kód konfigurace s. 390
1200	400	68	153	WRCMIC120L...	WRCMIC120P...
1200	500	68	153	WRCMIC120L...	WRCMIC120P...
1200	600	68	153	WRCMIC120L...	WRCMIC120P...
1620	400	77	192	WRCMIC162L...	WRCMIC162P...
1620	500	77	192	WRCMIC162L...	WRCMIC162P...
1620	600	77	192	WRCMIC162L...	WRCMIC162P...

Cena se počítá jako pro Ventily a příslušenství. Můžete také objednat ze Stránky 321

DOPORUČUJEME PRO PŘIPOJENÍ SX:



Sada tříosová termostatická s možností montáže topné tyče skrz ventil, Chrom

  WRZTCG4-CR: 147 EUR

  WRZTCG5-CR: 147 EUR

Stránka: 331



Sada krycí dvojité, Chrom

TGPCR001: 27 EUR

Stránka: 373



RADIÁTOR VODNÍ / VODNĚ-ELEKTRICKÝ (DOKOUPIT TOPNOU TYČ)

Připojení:

Výška [mm] 435÷1710,
Šíře [mm] 230÷530:

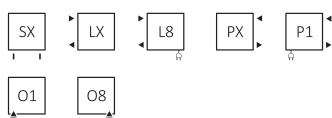

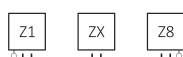

Výška [mm] 435÷1710,
Šíře [mm] 430÷530:



Výška [mm] 710÷1710,
Šíře [mm] 230÷530:



A ↕ [mm]	B ↔ [mm]	Barva ze vzorníku RAL a speciálních barev			Galvanický povrch Chrom			Barvy RAL a speciální barvy Cena bez DPH [EUR]	Chrom Cena bez DPH [EUR]	Kód produktu ... Kód konfigurace s. 385
		75/65/20°C [W]	55/45/20°C [W]	 [W]	75/65/20°C [W]	55/45/20°C [W]	 [W]			
435	430	203	106	200	142	72	120	180	300	WGMIK043043...
435	530	245	128	300	171	87	200	193	335	WGMIK043053...
460	230	122	64	120	85	44	120	135	244	WGMIK046023...
710	230	185	97	200	130	66	120	151	300	WGMIK071023...
735	430	337	176	400	236	120	200	204	408	WGMIK073043...
735	530	406	213	400	284	145	300	216	443	WGMIK073053...
960	230	247	130	300	173	88	200	171	356	WGMIK096023...
1035	430	466	245	400	326	167	300	228	491	WGMIK103043...
1035	530	563	295	600	394	201	400	241	538	WGMIK103053...
1210	230	308	162	300	216	110	200	186	412	WGMIK121023...
1335	430	593	312	600	415	212	400	241	586	WGMIK133043...
1335	530	715	376	800	501	255	600	264	659	WGMIK133053...
1460	230	367	193	400	257	131	300	201	466	WGMIK146023...
1635	430	716	377	800	501	256	600	264	682	WGMIK163043...
1635	530	864	454	800	605	308	600	287	766	WGMIK163053...
1710	230	425	224	400	298	152	300	217	521	WGMIK171023...

Mike E



Barva je zahrnuta v ceně



výběr připojení v ceně

RADIÁTOR ELEKTRICKÝ (CENA VČETNĚ NÁPLNĚ A ZVOLENÉ TOPNÉ TYČE)

Připojení:

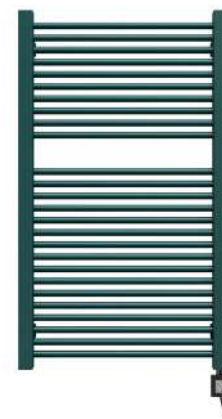

A ↕ [mm]	B ↔ [mm]	Výkon [W]		MEG Cena bez DPH [EUR]		MOA/DRY/TDY Cena bez DPH [EUR] (MOAIR: + 12 EUR) (MOABLUE: + 38 EUR)		ONE Cena bez DPH [EUR] (Nezabudovaná, v 8cm profilu v barvě radiátoru)		REG 2 Cena bez DPH [EUR]		REG 3 Cena bez DPH [EUR]		SIM Cena bez DPH [EUR]		Terma Split třída I Cena bez DPH [EUR] (nezapomeňte si koupit regulátor KTX)		Smart Split třída I Cena bez DPH [EUR] (nezapomeňte si koupit SMART Wi-Fi regulátor VEO)		Kód produktu ... Kód konfigurace s. 388
		Barva	Chrom	Barvy PAL a speciální barvy	Chrom	Barvy PAL a speciální barvy	Chrom	Barvy PAL a speciální barvy	Chrom	Barvy PAL a speciální barvy	Chrom	Barvy PAL a speciální barvy	Chrom	Barvy PAL a speciální barvy	Chrom	Barvy PAL a speciální barvy	Chrom	Barvy PAL a speciální barvy	Chrom	
460	230	120	120	230	339	237	346	257	366	207	317	217	327	198	307	183	292	183	292	WLMIK046023...
710	230	200	120	246	394	253	402	273	421	223	372	233	382	214	362	199	348	199	348	WLMIK071023...
960	230	300	200	265	451	273	458	292	478	243	429	253	439	233	419	218	404	218	404	WLMIK096023...
1210	230	300	200	281	506	289	514	308	533	259	484	269	494	249	474	234	459	234	459	WLMIK121023...
1460	230	400	300	296	560	303	568	323	587	274	538	284	548	264	528	249	514	249	514	WLMIK146023...
1710	230	400	300	312	616	319	623	339	643	290	593	300	603	280	584	265	569	265	569	WLMIK171023...
435	430	200	120	275	394	282	402	302	421	253	372	263	382	243	362	228	348	228	348	WLMIK043043...
435	530	300	200	287	430	295	437	314	457	265	408	275	418	255	398	241	383	241	383	WLMIK043053...
735	430	400	200	298	502	306	510	325	530	276	480	286	490	266	471	252	456	252	456	WLMIK073043...
735	530	400	300	311	538	318	546	338	565	289	516	298	526	279	506	264	491	264	491	WLMIK073053...
1035	430	400	400	323	586	330	593	350	613	301	564	311	574	291	554	276	539	276	539	WLMIK103043...
1035	530	600	600	335	633	343	640	362	660	313	611	323	621	303	601	289	586	289	586	WLMIK103053...
1335	430	600	400	335	681	343	688	362	708	313	659	323	668	303	649	289	634	289	634	WLMIK133043...
1335	530	800	600	359	753	366	761	386	780	336	731	346	741	327	721	312	707	312	707	WLMIK133053...
1635	430	800	600	359	777	366	784	386	804	336	755	346	764	327	745	312	730	312	730	WLMIK163043...
1635	530	800	600	382	860	389	868	409	887	360	838	370	848	350	828	335	814	335	814	WLMIK163053...

Mike One



Barva je zahrnuta v ceně



výběr připojení v ceně



TŘÍDA I



45-60°C/2



P-W-U



120-1000W



IR



IPx5



2h/1



Radiátor se zabudovanou topnou tyčí One. Funkce topné tyče ONE: Stránka 287.

DOPORUČUJEME PRO PŘIPOJENÍ S1 i S8:



Integrovaná sada termostatická s ponornou trubicí, Chrom

WRZT5G5-CR: 151EUR

WRZT5G6-CR: 151EUR

Stránka: 334



Sada krycí integrovaná, Chrom

TGPCR002: 38EUR

Stránka: 374



Regulátor TTIR1

TGRTBI001: 104EUR

Stránka: 304



RADIÁTOR VODNĚ-ELEKTRICKÝ (CENA VČETNĚ ZABUDOVANÉ TOPNÉ TYČE ONE)

Připojení:

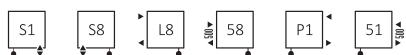

Vyber druh kabelu:

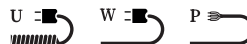

A ↕ [mm]	B ↔ [mm]	Barva ze vzorníku RAL a speciálních barev			Galvanický povrch Chrom			Barvy RAL a speciální barvy (Cena bez DPH [EUR])	Chrom (Cena bez DPH [EUR])	Kód produktu ... Kód konfigurace s. 386
		75/65/20°C [W]	55/45/20°C [W]	[W]	75/65/20°C [W]	55/45/20°C [W]	[W]			
710	230	185	97	200	130	66	120	248	396	WZMIN071023...
735	430	337	176	400	236	120	200	301	505	WZMIN073043...
735	530	406	213	400	284	145	300	313	541	WZMIN073053...
960	230	247	130	300	173	88	200	266	453	WZMIN096023...
1035	430	466	245	400	326	167	300	325	589	WZMIN103043...
1035	530	563	295	600	394	201	400	338	635	WZMIN103053...
1210	230	308	162	300	216	110	200	284	509	WZMIN121023...
1335	430	593	312	600	415	212	400	338	683	WZMIN133043...
1335	530	715	376	800	501	255	600	361	756	WZMIN133053...
1460	230	367	193	400	257	131	300	298	563	WZMIN146023...
1635	430	716	377	800	501	256	600	361	779	WZMIN163043...
1635	530	864	454	800	605	308	600	384	863	WZMIN163053...
1710	230	425	224	400	298	152	300	314	618	WZMIN171023...

Mike One E



Barva je zahrnuta v ceně



výběr připojení v ceně



RADIÁTOR ELEKTRICKÝ (CENA VČETNĚ NÁPLNĚ A ZABUDOVANÉ TOPNÉ TYČE ONE)

Připojení:

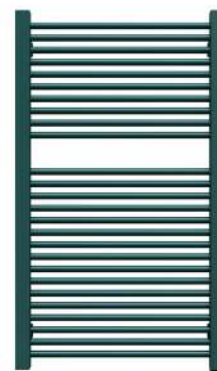

A ↕ [mm]	B ↔ [mm]	Výkon [W]		Barvy RAL a speciální barvy Cena bez DPH [EUR]	Chrom Cena bez DPH [EUR]	Kód produktu ... Kód konfigurace s. 387
		Barva	Chrom			
710	230	200	120	266	414	WWMIN071023...
735	430	400	200	319	523	WWMIN073043...
735	530	400	300	332	559	WWMIN073053...
960	230	300	200	285	472	WWMIN096023...
1035	430	400	300	344	607	WWMIN103043...
1035	530	600	400	356	654	WWMIN103053...
1210	230	300	200	302	527	WWMIN121023...
1335	430	600	400	356	702	WWMIN133043...
1335	530	800	400	380	774	WWMIN133053...
1460	230	400	600	317	581	WWMIN146023...
1635	430	800	600	380	798	WWMIN163043...
1635	530	800	600	403	881	WWMIN163053...
1710	230	400	300	333	637	WWMIN171023...

Nemo



Barva je zahrnuta v ceně

výběr připojení v ceně

DOPORUČUJEME PRO PŘIPOJENÍ VP, VL, V2 i V7:



Integrovaná sada uzavírací, Chrom

WRZOSSC1-CR: 116 EUR

Stránka: 335



Sada krycí integrovaná, Chrom

TGPCR002: 38 EUR

Stránka: 374



RADIÁTOR VODNÍ / VODNĚ-ELEKTRICKÝ (DOKOUPIT TOPNOU TYČ)

Připojení:

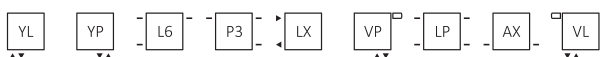

Šíře [mm] 645 ÷ 1725:

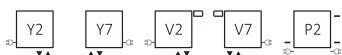

A ↑ [mm]	B ↔ [mm]	75/65/20°C [W]	55/45/20°C [W]	 [W]	Barvy RAL a speciální barvy Cena bez DPH [EUR]	Kód produktu ... Kód konfigurace s. 385
300	645	375	199	400	243	WGNEM030064...
300	915	533	282	600	290	WGNEM030091...
300	1185	690	365	800	338	WGNEM030118...
300	1455	847	448	800	386	WGNEM030145...
300	1725	1004	532	1000	434	WGNEM030172...
530	375	364	190	–	225	WGNEM053037...
530	645	626	327	600	293	WGNEM053064...
530	915	888	464	800	362	WGNEM053091...
530	1185	1150	600	1200	432	WGNEM053118...
530	1455	1412	737	1500	501	WGNEM053145...
530	1725	1675	875	1500	570	WGNEM053172...

Nemo E



Barva je zahrnuta v ceně



výběr připojení v ceně

RADIÁTOR ELEKTRICKÝ (CENA VČETNĚ NÁPLNĚ A ZVOLENÉ TOPNÉ TYČE)

Připojení:

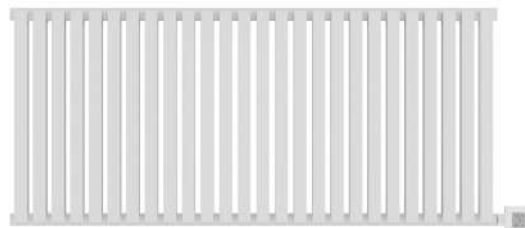

A ⇕ [mm]	B ↔ [mm]	Výkon [W]	MEG Cena bez DPH [EUR]	MOA/DRY/ TDY Cena bez DPH [EUR] (MOAIR: +12 EUR) (MOABLUE: +38 EUR)	ONE Cena bez DPH [EUR] (Nezabudovaná, v 8cm profilu v barvě radiátoru)	REG 2 Cena bez DPH [EUR]	REG 3 Cena bez DPH [EUR]	SIM Cena bez DPH [EUR]	Terma Split třída I Cena bez DPH [EUR] (nezapomeňte si koupit regulátor KTX)	Smart Split třída I Cena bez DPH [EUR] (nezapomeňte si koupit SMARTWi-Fi regulátor VEO)	Kód produktu ... Kód konfigurace s. 388
300	645	400	338	345	365	316	325	306	291	291	WLNEM030064...
300	915	600	384	392	412	362	372	352	338	338	WLNEM030091...
300	1185	800	432	440	459	410	420	400	386	386	WLNEM030118...
300	1455	800	480	488	507	458	468	448	434	434	WLNEM030145...
300	1725	1000	527	534	554	505	515	495	480	480	WLNEM030172...
530	375	–	–	–	–	–	–	–	–	–	WLNEM053037...
530	645	600	388	396	415	366	376	356	341	341	WLNEM053064...
530	915	800	457	464	484	435	445	425	410	410	WLNEM053091...
530	1185	1200	527	534	–	505	515	495	–	480	WLNEM053118...
530	1455	1500	–	–	–	–	–	564	–	549	WLNEM053145...
530	1725	1500	–	–	–	–	–	633	–	618	WLNEM053172...

Outcorner





 Barva je zahrnuta v ceně výběr připojení v ceně

DOPORUČUJEME PRO PŘIPOJENÍ SX:



Sada tříosová termostatická s možností montáže topné tyče skrz ventil, Chrom

  WRZTCG4-CR: 147 EUR

  WRZTCG5-CR: 147 EUR

Stránka: 331



Sada krycí dvojité, Chrom

TGPCR001: 27 EUR

Stránka: 373



RADIÁTOR VODNÍ / VODNĚ-ELEKTRICKÝ (DOKOUPIT TOPNOU TYČ)

Připojení:

Výška [mm] 465 ÷ 1545:



Výška [mm] 735 ÷ 1545:



A ↓ [mm]	B ↔ [mm]	75/65/20°C [W]	55/45/20°C [W]	 [W]	Barvy RAL a speciální barvy Cena bez DPH [EUR]	Kód produktu ... Kód konfigurace s. 385
465	300	294	160	300	271	WGQON046030...
735	300	421	228	400	301	WGQON073030...
1005	300	547	294	600	332	WGQON100030...
1275	300	673	361	800	361	WGQON127030...
1545	300	799	428	800	392	WGQON154030...

Outcorner E



Barva je zahrnuta v ceně



výběr připojení v ceně

RADIÁTOR ELEKTRICKÝ (CENA VČETNĚ NÁPLNĚ A ZVOLENÉ TOPNÉ TYČE)

Připojení:

E1

E8



A ↕ [mm]	B ↔ [mm]	Výkon [W]	MEG Cena bez DPH [EUR]	MOA/DRY/ TDY Cena bez DPH [EUR] (MOAIR: +12 EUR) (MOABLUE: +38 EUR)	ONE Cena bez DPH [EUR] (Nezabudovaná, v 8cm profilu v barvě radiátoru)	REG 2 Cena bez DPH [EUR]	REG 3 Cena bez DPH [EUR]	SIM Cena bez DPH [EUR]	Terma Split třída I Cena bez DPH [EUR] (nezapomeňte si koupit regulátor KTX)	Smart Split třída I Cena bez DPH [EUR] (nezapomeňte si koupit SMARTWi-Fi regulátor VEO)	Kód produktu ... Kód konfigurace s. 388
465	300	300	366	373	393	344	354	334	319	319	WLQON046030...
735	300	400	396	403	423	373	383	364	349	349	WLQON073030...
1005	300	600	426	434	453	404	414	394	380	380	WLQON100030...
1275	300	800	456	463	483	434	443	424	409	409	WLQON127030...
1545	300	800	487	494	514	464	474	455	440	440	WLQON154030...

SADA OBSAHUJE:



Dřevěné masivní věšáky

RADIÁTOR VODNÍ / VODNĚ-ELEKTRICKÝ (DOKOUPIT TOPNOU TYČ)

Připojení:



Radiátor je vyhotoven z měděných povrchově neupravených trubek a časem může chytat tmavší patinu.

A ↕ [mm]	B ↔ [mm]	75/65/20°C [W]	55/45/20°C [W]	 [W]	Standardní barva RAW COPPER Cena bez DPH [EUR]	Kód produktu ... Kód konfigurace s. 385
1000	431	300	165	300	1 099	WGPAJ100043...
1000	531	339	184	400	1 153	WGPAJ100053...
1000	631	380	205	400	1 232	WGPAJ100063...
1400	431	368	199	400	1 139	WGPAJ140043...
1400	531	424	227	400	1 183	WGPAJ140053...
1400	631	480	256	600	1 274	WGPAJ140063...
1800	431	437	234	400	1 176	WGPAJ180043...
1800	531	510	272	600	1 226	WGPAJ180053...
1800	631	582	310	600	1 310	WGPAJ180063...

Pajak E



výběr připojení
v ceně

SADA OBSAHUJE:



Dřevěné masivní věšáky

RADIÁTOR ELEKTRICKÝ (CENA VČETNĚ NÁPLNĚ A ZVOLENÉ TOPNÉ TYČE)

Připojení:

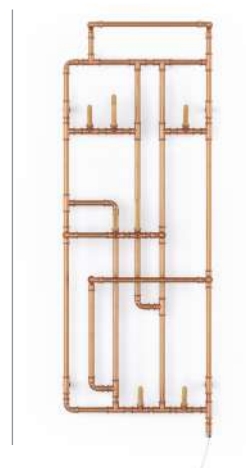

Radiátor je vyhotoven z měděných povrchově neupravených trubek a časem může chytat tmavší patinu.

A ↓ [mm]	B ↔ [mm]	Výkon [W]	MEG Cena bez DPH [EUR]	MOA/DRY/ TDY Cena bez DPH [EUR] (MOAIR: +12 EUR) (MOABLUE: +38 EUR)	ONE Cena bez DPH [EUR] (Nezabudovaná, v 8cm profilu v barvě radiátoru)	REG 2 Cena bez DPH [EUR]	REG 3 Cena bez DPH [EUR]	SIM Cena bez DPH [EUR]	Terma Split třída I Cena bez DPH [EUR] (nezapomeňte si koupit regulátor KTX)	Smart Split třída I Cena bez DPH [EUR] (nezapomeňte si koupit SMARTWi-Fi regulátor VEO)	Kód produktu ... Kód konfigurace s. 388
923	431	300	1193	1200	1219	1171	1180	1160	1145	1145	WLPAJ092043...
923	531	400	1247	1254	1273	1225	1234	1214	1199	1199	WLPAJ092053...
923	631	400	1326	1333	1353	1304	1314	1294	1279	1279	WLPAJ092063...
1323	431	400	1233	1240	1260	1211	1220	1201	1186	1186	WLPAJ132043...
1323	531	400	1277	1284	1304	1255	1264	1245	1230	1230	WLPAJ132053...
1323	631	600	1368	1375	1394	1346	1355	1335	1320	1320	WLPAJ132063...
1723	431	400	1270	1277	1296	1248	1257	1237	1222	1222	WLPAJ172043...
1723	531	600	1320	1327	1347	1298	1308	1288	1273	1273	WLPAJ172053...
1723	631	600	1404	1411	1431	1382	1391	1371	1356	1356	WLPAJ172063...

Passo HX



Barva je zahrnuta v ceně



výběr připojení v ceně

DOPORUČUJEME PRO PŘIPOJENÍ SX:



Sada tříosová termostatická, Chrom

WRZTCG1-CR: 143EUR

WRZTCG2-CR: 143EUR

Stránka: 330



Sada krycí dvojitá, Chrom

TGPCR001: 27EUR

Stránka: 373

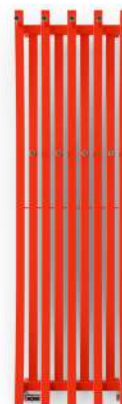

RADIÁTOR VODNÍ

Připojení:



A ↕ [mm]	B ↔ [mm]	75/65/20°C [W]	55/45/20°C [W]	Barvy RAL a speciální barvy Cena bez DPH [EUR]	Kód produktu ... Kód konfigurace s. 385
1800	520	889	457	835	WGPSW180052...
1800	760	1275	638	935	WGPSW180076...

Passo MH



Barva je zahrnuta v ceně



výběr připojení v ceně

DOPORUČUJEME PRO PŘIPOJENÍ SX:



Sada tříosová termostatická, Chrom

WRZTCG1-CR: 143EUR

WRZTCG2-CR: 143EUR

Stránka: 330



Sada krycí dvojitá, Chrom

TGPCR001: 27EUR

Stránka: 373



RADIÁTOR VODNÍ

Připojení:



A ↕ [mm]	B ↔ [mm]	75/65/20°C [W]	55/45/20°C [W]	Barvy RAL a speciální barvy Cena bez DPH [EUR]	Kód produktu ... Kód konfigurace s.385
1800	520	766	391	825	WGPLW180052...
1800	760	958	489	905	WGPLW180076...

Perla



Barva je zahrnuta v ceně

DOPORUČUJEME:



Sada krycí integrovaná, Chrom

TGPCR002: 38 EUR

Stránka: 374



Integrovaná sada uzavírací, Chrom

WRZOSSC1-CR: 116 EUR

Stránka: 335



RADIÁTOR VODNÍ:

Připojení:



A ⇕ [mm]	B ↔ [mm]	Barva ze vzorníku RAL a speciálních barev		Galvanický povrch Chrom		Barvy RAL a speciální barvy Cena bez DPH [EUR]	Chrom Cena bez DPH [EUR]	Kód produktu ... Kód konfigurace s. 385
		75/65/20°C [W]	55/45/20°C [W]	75/65/20°C [W]	55/45/20°C [W]			
960	500	337	178	229	119	719	918	WGPER096050...
960	600	371	198	252	134	741	937	WGPER096060...
1360	500	478	253	325	168	822	1 000	WGPER136050...
1360	600	528	282	359	190	855	1 031	WGPER136060...
1760	500	630	334	419	218	887	1 078	WGPER176050...
1760	600	704	377	488	260	920	1 109	WGPER176060...

Perla E



RADIÁTOR ELEKTRICKÝ (CENA VČETNĚ VYHŘÍVÁNÍ TOPNÝM KABLEM)

Připojení:



Vyber druh kabelu:

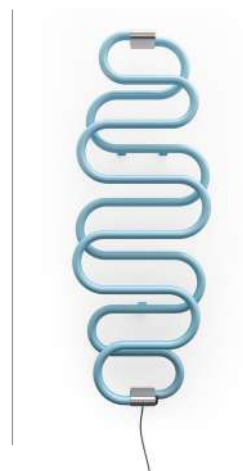
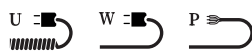

A ↕ [mm]	B ↔ [mm]	Výkon [W]		Barvy RAL a speciální barvy Cena bez DPH [EUR]	Chrom Cena bez DPH [EUR]	Kód produktu ... Kód konfigurace s. 389
		Barva	Chrom			
1360	500	284	213	842	1045	WSPER136050...
1760	600	455	284	933	1152	WSPER176060...

* Radiátor s topným kabelem v celém těle. Druh kabelu zvolte W, P nebo U. Viz Legenda Druhů kabelů - Stránka 284

Pier



Barva je zahrnuta v ceně



výběr připojení v ceně

DOPORUČUJEME PRO PŘIPOJENÍ SX:



Sada tříosová termostatická, Chrom

WRZTCG1-CR: 143EUR

WRZTCG2-CR: 143EUR

Stránka: 330



Sada krycí dvojitá, Chrom

TGPCR001: 27EUR

Stránka: 373



RADIÁTOR VODNÍ:

Připojení:



A ⇕ [mm]	B ⇔ [mm]	75/65/20°C [W]	55/45/20°C [W]	Barvy RAL a speciální barvy Cena bez DPH [EUR]	Kód produktu ... Kód konfigurace s. 385
1380	410	564	303	420	WGB19138041...
1680	410	687	360	450	WGB19168041...
1800	580	1025	532	566	WGB19180058...

PLC V



Barva je zahrnuta v ceně



výběr připojení v ceně

DOPORUČUJEME:



Integrovaná sada termostatická, Chrom

WRZT5G1-CR: 145 EUR

WRZT5G2-CR: 145 EUR

Stránka: 332



Sada krycí integrovaná, Chrom

TGPCR002: 38 EUR

Stránka: 374



RADIÁTOR VODNÍ:

Připojení:

Šíře [mm] 263

Šíře [mm] 463 ÷ 663:



A ⇕ [mm]	B ⇔ [mm]	75/65/20°C [W]	55/45/20°C [W]	Barvy RAL a speciální barvy Cena bez DPH [EUR]	Kód produktu ... Kód konfigurace s. 385
1580	263	331	169	1 638	WGPLV158026...
1600	463	613	312	2 102	WGPLV160046...
1600	663	894	456	2 617	WGPLV160066...
1780	263	373	190	1 715	WGPLV178026...
1800	463	690	352	2 230	WGPLV180046...
1800	663	1007	514	2 745	WGPLV180066...

PLC H



Barva je zahrnuta v ceně



výběr připojení v ceně

DOPORUČUJEME:



Sada rohová termostatická, Chrom

WRZTCG3-CR: 134 EUR

Stránka: 328



Sada krycí dvojitá, Chrom

TGPCR001: 27 EUR

Stránka: 373



RADIÁTOR VODNÍ:

Připojení:



A ↕ [mm]	B ↔ [mm]	75/65/20°C [W]	55/45/20°C [W]	Barvy RAL a speciální barvy Cena bez DPH [EUR]	Kód produktu ... Kód konfigurace s. 385
263	1600	341	174	2 145	WGPLH026160...
463	1600	622	317	2 461	WGPLH046160...

POC 2





 Barva je zahrnuta v ceně výběr připojení v ceně

DOPORUČUJEME PRO PŘIPOJENÍ SX:



Sada tříosová termostatická, Chrom

WRZTCG1-CR: 143EUR

WRZTCG2-CR: 143EUR

Stránka: 330



Sada krycí dvojité, Chrom

TGPCR001: 27EUR

Stránka: 373



Háček bodový YO!

WRWYOY001*: 4EUR

Stránka: 316



Topná tyč MOA IR, Chrom

WEMOR*: 117EUR

Stránka: 294



RADIÁTOR VODNÍ / VODNĚ-ELEKTRICKÝ (DOKOUPIT TOPNOU TYČ)

Připojení:

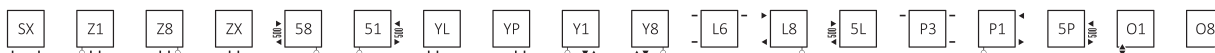

A ↕ [mm]	B ↔ [mm]	75/65/20°C [W]	55/45/20°C [W]	 [W]	Barvy RAL a speciální barvy Cena bez DPH [EUR]	Kód produktu ... Kód konfigurace s. 385
600	450	308	167	300	220	WGZUL060045...
600	500	342	185	400	225	WGZUL060050...
600	600	410	222	400	234	WGZUL060060...
840	450	443	239	400	248	WGZUL084045...
840	500	493	266	600	258	WGZUL084050...
840	600	590	318	600	266	WGZUL084060...
840	700	690	372	800	281	WGZUL084070...
1040	450	556	299	600	269	WGZUL104045...
1040	500	618	332	600	276	WGZUL104050...
1040	600	743	399	800	286	WGZUL104060...
1040	700	866	465	800	295	WGZUL104070...
1240	450	669	359	800	290	WGZUL124045...
1240	500	744	399	800	300	WGZUL124050...
1240	600	893	479	1000	313	WGZUL124060...
1240	700	1041	559	1000	328	WGZUL124070...
1400	500	844	452	800	346	WGZUL140050...
1400	600	1013	543	1000	365	WGZUL140060...
1400	700	1182	633	1200	388	WGZUL140070...

POC 2 E



Barva je zahrnutá v ceně



výběr připojení v ceně

RADIÁTOR ELEKTRICKÝ (CENA VČETNĚ NÁPLNĚ A ZVOLENÉ TOPNÉ TYČE)

Připojení:



A ↕ [mm]	B ↔ [mm]	Výkon [W]	MEG Cena bez DPH [EUR]	MOA/DRY/TDY Cena bez DPH [EUR] (MOAIR: +12 EUR) (MOABLUE: +38 EUR)	ONE Cena bez DPH [EUR] (Nezabudovaná, v 8cm profilu v barvě radiátoru)	REG 2 Cena bez DPH [EUR]	REG 3 Cena bez DPH [EUR]	SIM Cena bez DPH [EUR]	Terma Split třída I Cena bez DPH [EUR] (nezapomeňte si koupit regulátor KTX)	Smart Split třída I Cena bez DPH [EUR] (nezapomeňte si koupit SMART Wi-Fi regulátor VEO)	Kód produktu ... Kód konfigurace s.388
600	450	300	314	322	341	292	302	282	268	268	WLZUL060045...
600	500	400	319	327	346	297	307	287	273	273	WLZUL060050...
600	600	400	329	336	356	307	317	297	282	282	WLZUL060060...
840	450	400	343	350	370	321	330	311	296	296	WLZUL084045...
840	500	600	352	360	380	330	340	321	306	306	WLZUL084050...
840	600	600	361	368	388	339	349	329	314	314	WLZUL084060...
840	700	800	376	383	403	354	364	344	329	329	WLZUL084070...
1040	450	600	364	371	391	341	351	332	317	317	WLZUL104045...
1040	500	600	371	378	398	349	359	339	324	324	WLZUL104050...
1040	600	800	381	388	408	359	368	349	334	334	WLZUL104060...
1040	700	800	389	397	416	367	377	357	343	343	WLZUL104070...
1240	450	800	384	392	412	362	372	352	338	338	WLZUL124045...
1240	500	800	394	402	421	372	382	362	348	348	WLZUL124050...
1240	600	1000	408	415	435	386	396	376	361	361	WLZUL124060...
1240	700	1000	423	430	450	400	410	391	376	376	WLZUL124070...
1400	500	800	441	448	468	419	429	409	394	394	WLZUL140050...
1400	600	1000	459	467	487	437	447	427	413	413	WLZUL140060...
1400	700	1200	483	490	510	461	471	451	436	436	WLZUL140070...

Pola



DOPORUČUJEME PRO PŘIPOJENÍ SX:



Sada tříosová termostatická, Chrom

WRZTCG1-CR: 143EUR

WRZTCG2-CR: 143EUR

Stránka: 330



Sada krycí dvojitá, Chrom

TGPCR001: 27EUR

Stránka: 373



Háček bodový YO!

WRWYOY001*: 4EUR

Stránka: 316

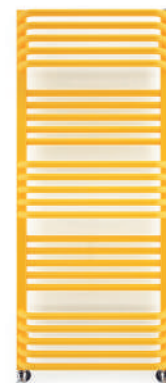

RADIÁTOR VODNÍ / VODNĚ-ELEKTRICKÝ (DOKOUPIT TOPNOU TYČ)

Připojení:

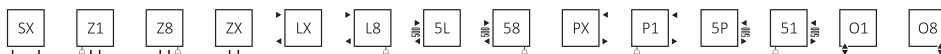

A ↓ [mm]	B ↔ [mm]	Barva ze vzorníku RAL a speciálních barev			Galvanický povrch Chrom			Barvy RAL a speciální barvy Cena bez DPH [EUR]	Chrom Cena bez DPH [EUR]	Kód produktu ... Kód konfigurace s. 385
		75/65/20°C [W]	55/45/20°C [W]	[W]	75/65/20°C [W]	55/45/20°C [W]	[W]			
780	500	392	211	400	274	140	300	202	522	WGPAL078050...
780	600	471	254	400	330	168	300	212	569	WGPAL078060...
1180	500	638	342	600	447	228	400	250	646	WGPAL118050...
1180	600	766	411	800	536	273	600	268	692	WGPAL118060...
1580	500	883	473	800	618	315	600	287	892	WGPAL158050...
1580	600	1061	568	1000	743	379	800	324	954	WGPAL158060...

Pola E



Barva je zahrnuta v ceně



výběr připojení v ceně

RADIÁTOR ELEKTRICKÝ (CENA VČETNĚ NÁPLNĚ A ZVOLENÉ TOPNÉ TYČE)

Připojení:

E1

E8



A ↕ [mm]	B ↔ [mm]	Výkon [W]		MEG Cena bez DPH [EUR]		MOA/DRY/TDY Cena bez DPH [EUR] (MOAIR: +12 EUR) (MOABLUE: +38 EUR)		ONE Cena bez DPH [EUR] (Nezabudovaná, v 8cm profilu v barvě radiátoru)		REG 2 Cena bez DPH [EUR]		REG 3 Cena bez DPH [EUR]		SIM Cena bez DPH [EUR]		Terma Split třída I Cena bez DPH [EUR] (nezapomeňte si koupit regulátor KTX)		Smart Split třída I Cena bez DPH [EUR] (nezapomeňte si koupit SMART Wi-Fi regulátor VEO)		Kód produktu ... Kód konfigurace s. 388
		Barva	Chrom	Barvy RAL a speciální barvy	Chrom	Barvy RAL a speciální barvy	Chrom	Barvy RAL a speciální barvy	Chrom	Barvy RAL a speciální barvy	Chrom	Barvy RAL a speciální barvy	Chrom	Barvy RAL a speciální barvy	Chrom	Barvy RAL a speciální barvy	Chrom			
780	500	400	300	297	617	305	624	324	644	275	595	285	605	265	585	250	570	250	570	WLPAL078050...
780	600	400	300	307	664	314	671	334	691	285	641	295	651	275	632	260	617	260	617	WLPAL078060...
1180	500	600	400	345	741	352	748	372	768	323	719	333	729	313	709	298	694	298	694	WLPAL118050...
1180	600	800	600	362	787	370	794	389	814	340	764	350	774	330	755	316	740	316	740	WLPAL118060...
1580	500	800	600	382	987	389	994	409	1014	360	965	370	975	350	955	335	940	335	940	WLPAL158050...
1580	600	1000	800	418	1048	425	1056	445	1075	396	1026	405	1036	386	1016	371	1002	371	1002	WLPAL158060...

Pola One



Barva je zahrnuta v ceně



výběr připojení v ceně



TŘÍDA I



45-60°C/2



P-W-U



120-1000W



IR



IPx5



2h/1



DOPORUČUJEME PRO PŘIPOJENÍ S1 i S8:



Integrovaná sada termostatická s ponornou trubicí, Chrom

WRZT5G5-CR: 151EUR

WRZT5G6-CR: 151EUR

Stránka: 334



Sada krycí integrovaná, Chrom

TGPCR002: 38EUR

Stránka: 374



Háček bodový YO!

WRWYOY001*: 4EUR

Stránka: 316



RADIÁTOR VODNĚ-ELEKTRICKÝ (CENA VČETNĚ ZABUDOVANÉ TOPNÉ TYČE ONE)

Připojení:



Vyber druh kabelu:



A ↓ [mm]	B ↔ [mm]	Barva ze vzorníku RAL a speciálních barev			Galvanický povrch Chrom			Barvy RAL a speciální barvy Cena bez DPH [EUR]	Chrom Cena bez DPH [EUR]	Kód produktu ... Kód konfigurace s. 386
		75/65/20°C [W]	55/45/20°C [W]	[W]	75/65/20°C [W]	55/45/20°C [W]	[W]			
780	500	392	211	400	274	140	300	300	619	WZPAN078050...
780	600	471	254	400	330	168	300	309	666	WZPAN078060...
1180	500	638	342	600	447	228	400	348	743	WZPAN118050...
1180	600	766	411	800	536	273	600	365	789	WZPAN118060...
1580	500	883	473	800	618	315	600	384	989	WZPAN158050...
1580	600	1061	568	1000	743	379	800	420	1051	WZPAN158060...

Pola One E



Barva je zahrnuta v ceně

výběr připojení v ceně



RADIÁTOR ELEKTRICKÝ (CENA VČETNĚ NÁPLNĚ A ZABUDOVANÉ TOPNÉ TYČE ONE)

Připojení:

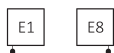

Vyber druh kabelu:

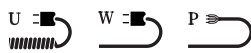

A ↕ [mm]	B ↔ [mm]	Výkon [W]		Barvy RAL a speciální barvy Cena bez DPH [EUR]	Chrom Cena bez DPH [EUR]	Kód produktu ... Kód konfigurace s. 387
		Barva	Chrom			
780	500	400	300	318	638	WWPAN078050...
780	600	400	300	328	684	WWPAN078060...
1180	500	600	400	366	762	WWPAN118050...
1180	600	800	600	383	807	WWPAN118060...
1580	500	800	600	403	1008	WWPAN158050...
1580	600	1000	800	439	1069	WWPAN158060...

Quadrus Bold



Barva je zahrnuta v ceně



výběr připojení v ceně

DOPORUČUJEME PRO PŘIPOJENÍ: Z1, Z8 i ZX:



Integrovaná sada termostatická, Chrom

 WRZT5G1-CR: 145 EUR

 WRZT5G2-CR: 145 EUR

Stránka: 332



Sada krycí integrovaná, Chrom

TGPCR002: 38 EUR

Stránka: 374



RADIÁTOR VODNÍ / VODNĚ-ELEKTRICKÝ (DOKOUPIT TOPNOU TYČ)

Připojení:

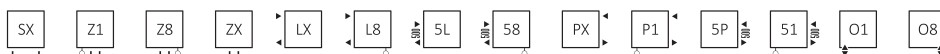

A ↕ [mm]	B ↔ [mm]	75/65/20°C [W]	55/45/20°C [W]	 [W]	Barvy RAL a speciální barvy Cena bez DPH [EUR]	Kód produktu ... Kód konfigurace s. 385
870	450	531	285	600	391	WGQBA087045...
870	600	708	380	800	424	WGQBA087060...
1185	450	835	446	800	441	WGQBA118045...
1185	600	1113	594	1000	490	WGQBA118060...

Quadrus Bold E



Barva je zahrnuta v ceně



výběr připojení v ceně

RADIÁTOR ELEKTRICKÝ (CENA VČETNĚ NÁPLNĚ A ZVOLENÉ TOPNÉ TYČE)

Připojení:

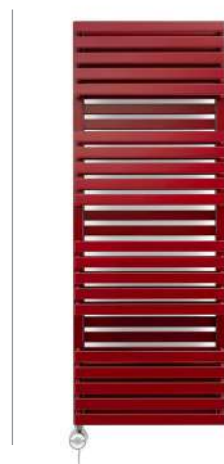

A ↕ [mm]	B ↔ [mm]	Výkon [W]	MEG Cena bez DPH [EUR]	MOA/DRY/ TDY Cena bez DPH [EUR] (MOAIR: +12 EUR) (MOA BLUE: +38 EUR)	ONE Cena bez DPH [EUR] (Nezabudovaná, v 8cm profilu v barvě radiátoru)	REG 2 Cena bez DPH [EUR]	REG 3 Cena bez DPH [EUR]	SIM Cena bez DPH [EUR]	Terma Split třída I Cena bez DPH [EUR] (nezapomeňte si koupit regulátor KTX)	Smart Split třída I Cena bez DPH [EUR] (nezapomeňte si koupit SMART Wi-Fi regulátor VEO)	Kód produktu ... Kód konfigurace s. 388
870	450	600	485	493	512	463	473	453	439	439	WLQBA087045...
870	600	800	518	526	546	496	506	487	472	472	WLQBA087060...
1185	450	800	534	542	562	512	522	502	488	488	WLQBA118045...
1185	600	1000	585	592	612	563	573	553	538	538	WLQBA118060...

Quadrus Bold One



Barva je zahrnuta v ceně



výběr připojení v ceně



TŘÍDA I



IPx5



2h/1



SADA OBSAHUJE:

Radiátor se zabudovanou topnou tyčí One. Funkce topné tyče ONE: Stránka 287.

DOPORUČUJEME PRO PŘIPOJENÍ S1 i S8:



Integrovaná sada termostatická s ponornou trubicí, Chrom

WRZT5G5-CR: 151 EUR

WRZT5G6-CR: 151 EUR

Stránka: 334



Sada krycí integrovaná, Chrom

TGPCR002: 38 EUR

Stránka: 374



RADIÁTOR VODNĚ-ELEKTRICKÝ (CENA VČETNĚ ZABUDOVANÉ TOPNÉ TYČE ONE)

Připojení:



Vyber druh kabelu:



A ↕ [mm]	B ↔ [mm]	75/65/20°C [W]	55/45/20°C [W]	 [W]	Barvy RAL a speciální barvy Cena bez DPH [EUR]	Kód produktu ... Kód konfigurace s. 386
870	450	531	285	600	488	WZQBN087045...
870	600	708	380	800	521	WZQBN087060...
1185	450	835	446	800	537	WZQBN118045...
1185	600	1113	594	1000	587	WZQBN118060...

Quadrus Bold One E



Barva je zahrnuta v ceně



výběr připojení v ceně



TŘÍDA I



45-60°C/2



P-W-U



120-1000W



IR



IPx5



2h/1



RADIÁTOR ELEKTRICKÝ (CENA VČETNĚ NÁPLNĚ A ZABUDOVANÉ TOPNÉ TYČE ONE)

Připojení:



Vyber druh kabelu:

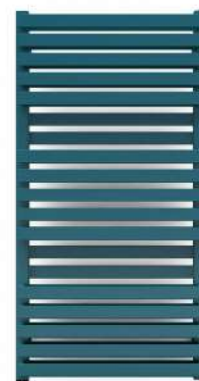

A ↕ [mm]	B ↔ [mm]	Výkon [W]	Barvy RAL a speciální barvy Cena bez DPH [EUR]	Kód produktu ... Kód konfigurace s. 387
870	450	600	506	WWQBN087045...
870	600	800	539	WWQBN087060...
1185	450	800	555	WWQBN118045...
1185	600	1000	606	WWQBN118060...

Quadrus Slim



Barva je zahrnuta v ceně

výběr připojení v ceně

DOPORUČUJEME PRO PŘIPOJENÍ Z1, Z8 i ZX:



Integrovaná sada termostatická,
Chrom

WRZT5G1-CR: 145 EUR

WRZT5G2-CR: 145 EUR

Stránka: 332



Sada krycí integrovaná, Chrom

TGPCR002: 38 EUR

Stránka: 374



Topná tyč REG 2, Černá

WER2G01*: 76 EUR

Stránka: 300



RADIÁTOR VODNÍ / VODNĚ-ELEKTRICKÝ (DOKOUPIT TOPNOU TYČ)

Připojení:

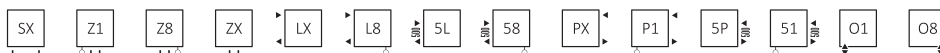

A ↕ [mm]	B ↔ [mm]	75/65/20°C [W]	55/45/20°C [W]	[W]	Barvy RAL a speciální barvy Cena bez DPH [EUR]	Kód produktu ... Kód konfigurace s. 385
870	450	409	217	400	311	WGQUS087045...
870	600	559	296	600	327	WGQUS087060...
1185	450	537	278	600	344	WGQUS118045...
1185	600	733	379	800	377	WGQUS118060...

Quadrus Slim E



Barva je zahrnutá v ceně



výběr připojení v ceně

RADIÁTOR ELEKTRICKÝ (CENA VČETNĚ NÁPLNĚ A ZABUDOVANÉ TOPNÉ TYČE ONE)

Připojení:



A ↕ [mm]	B ↔ [mm]	Výkon [W]	MEG Cena bez DPH [EUR]	MOA/DRY/ TDY Cena bez DPH [EUR] (MOAIR: +12 EUR) (MOA BLUE: +38 EUR)	ONE Cena bez DPH [EUR] (Nezabudovaná, v 8cm profilu v barvě radiátoru)	REG 2 Cena bez DPH [EUR]	REG 3 Cena bez DPH [EUR]	SIM Cena bez DPH [EUR]	Terma Split třída I Cena bez DPH [EUR] (nezapomeňte si koupit regulátor KTX)	Smart Split třída I Cena bez DPH [EUR] (nezapomeňte si koupit SMART Wi-Fi regulátor VEO)	Kód produktu ... Kód konfigurace s. 388
870	450	400	405	413	432	383	393	373	359	359	WLQUS087045...
870	600	600	421	429	448	399	409	389	375	375	WLQUS087060...
1185	450	600	439	446	466	416	426	407	392	392	WLQUS118045...
1185	600	800	472	479	499	450	459	440	425	425	WLQUS118060...

Quadrus Slim One



Barva je zahrnuta v ceně



výběr připojení v ceně



45-60°C/2



P-W-U



120-1000W



IR



TŘÍDA I



IPx5



2h/1



SADA OBSAHUJE:

Radiátor se zabudovanou topnou tyčí One. Funkce topné tyče ONE: Stránka 287.

DOPORUČUJEME PRO PŘIPOJENÍ S1 i S8:



Integrovaná sada termostatická s ponornou trubicí, Chrom

WRZT5G5-CR: 151EUR

WRZT5G6-CR: 151EUR

Stránka: 334



Sada krycí integrovaná, Chrom

TGPCR002: 38EUR

Stránka: 374



Regulátor TTIR1

TGRTBI001: 104EUR

Stránka: 304



RADIÁTOR VODNĚ-ELEKTRICKÝ (CENA VČETNĚ ZABUDOVANÉ TOPNÉ TYČE ONE)

Připojení:

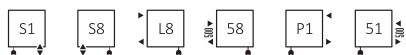

Vyber druh kabelu:

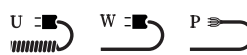

A ↕ [mm]	B ↔ [mm]	75/65/20°C [W]	55/45/20°C [W]	☺ [W]	Barvy RAL a speciální barvy Cena bez DPH [EUR]	Kód produktu ... Kód konfigurace s. 386
870	450	409	217	400	408	WZQSN087045...
870	600	559	296	600	424	WZQSN087060...
1185	450	537	278	600	441	WZQSN118045...
1185	600	733	379	800	474	WZQSN118060...

Quadrus Slim One E



Barva je zahrnuta v ceně



výběr připojení v ceně

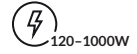

RADIÁTOR ELEKTRICKÝ (CENA VČETNĚ NÁPLNĚ A ZABUDOVANÉ TOPNÉ TYČE ONE)

Připojení:



Vyber druh kabelu:

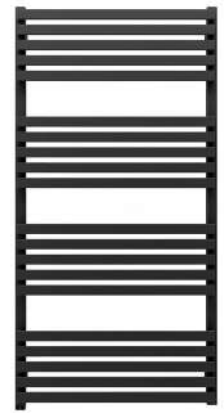

A ↕ [mm]	B ↔ [mm]	Výkon [W]	Barvy RAL a speciální barvy Cena bez DPH [EUR]	Kód produktu ... Kód konfigurace s. 387
870	450	400	426	WWQSN087045...
870	600	600	442	WWQSN087060...
1185	450	600	459	WWQSN118045...
1185	600	800	493	WWQSN118060...

Retro



Barva je zahrnuta v ceně

výběr připojení v ceně

DOPORUČUJEME:



Sada krycí dvojité, Chrom

TGPCR001: 27 EUR

Stránka: 373



Sada regulační rohová Star, Chrom

TGERSTCR01: 148 EUR

Stránka: 327

Vhodné jsou také ventily MINIMALIST.

Stránka: 344



RADIÁTOR VODNÍ / VODNĚ-ELEKTRICKÝ (DOKOUPIT TOPNOU TYČ)

Připojení:



B ↔ [mm]	B ↔ [mm]	Barva ze vzorníku RAL a speciálních barev			Galvanický povrch Chrom			Barvy RAL a speciální barvy Cena bez DPH [EUR]	Chrom Cena bez DPH [EUR]	Kód produktu ... Kód konfigurace s. 385
		75/65/20°C [W]	55/45/20°C [W]	[W]	75/65/20°C [W]	55/45/20°C [W]	[W]			
430	504	115	63	120	81	44	120	319	426	WGRE1043050...
800	504	210	114	200	147	80	120	377	561	WGRE1080050...
1170	504	308	165	300	216	116	200	441	695	WGRE1117050...
1540	504	405	216	400	284	151	300	500	854	WGRE1154050...

Retro E



Barva je zahrnuta v ceně



výběr připojení v ceně

RADIÁTOR ELEKTRICKÝ (CENA VČETNĚ NÁPLNĚ A ZVOLENÉ TOPNÉ TYČE)

Připojení:



A ↕ [mm]	B ↔ [mm]	Výkon [W]		MEG Cena bez DPH [EUR]		MOA/DRY/TDY Cena bez DPH [EUR] (MOAIR: +12 EUR) (MOABLU: +38 EUR)		ONE Cena bez DPH [EUR] (Nezabudovaná, v 8cm profilu v barvě radiátoru)		REG 2 Cena bez DPH [EUR]		REG 3 Cena bez DPH [EUR]		SIM Cena bez DPH [EUR]		Terma Split třída I Cena bez DPH [EUR] (nezapomeňte si koupit regulátor KTX)		Smart Split třída I Cena bez DPH [EUR] (nezapomeňte si koupit SMART Wi-Fi regulátor VEO)		Kód produktu ... Kód konfigurace s. 388
		Barva	Chrom	Barvy RAL a speciální barvy	Chrom	Barvy RAL a speciální barvy	Chrom	Barvy RAL a speciální barvy	Chrom	Barvy RAL a speciální barvy	Chrom	Barvy RAL a speciální barvy	Chrom	Barvy RAL a speciální barvy	Chrom	Barvy RAL a speciální barvy	Chrom	Barvy RAL a speciální barvy	Chrom	
430	504	120	120	403	515	410	522	430	542	381	493	391	502	371	483	356	468	356	468	WLRE1043050...
800	504	200	120	463	657	471	665	490	684	441	635	451	645	431	625	416	611	416	611	WLRE1080050...
1170	504	300	200	530	799	537	806	557	826	507	777	517	787	498	767	483	752	483	752	WLRE1117050...
1540	504	400	300	592	964	600	971	619	991	570	941	580	951	560	932	546	917	546	917	WLRE1154050...

Retro S



DOPORUČUJEME:



Sada krycí dvojité, Chrom

TGPCR001: 27 EUR

Stránka: 373



Sada regulační rohová Star, Chrom

TGERSTCR01: 148 EUR

Stránka: 327

Vhodné jsou také ventily MINIMALIST.

Stránka: 344



RADIÁTOR VODNÍ

Připojení:



A ↕ [mm]	B ↔ [mm]	Barva ze vzorníku RAL a speciálních barev		Galvanický povrch Chrom		Barvy RAL a speciální barvy Cena bez DPH [EUR]	Chrom Cena bez DPH [EUR]	Kód produktu ... Kód konfigurace s. 385
		75/65/20°C [W]	55/45/20°C [W]	75/65/20°C [W]	55/45/20°C [W]			
875	504	200	109	140	71	404	570	WGR1S087050...
1060	504	240	131	168	86	431	645	WGR1S106050...
1245	504	283	153	198	101	464	725	WGR1S124050...
1430	504	325	175	228	116	492	795	WGR1S143050...

Ribbon V

  Barva je zahrnuta v ceně

DOPORUČUJEME:



Integrovaná sada termostatická, Chrom

 WRZT5G1-CR: 145 EUR

 WRZT5G2-CR: 145 EUR

Stránka: 332



Sada krycí integrovaná, Chrom

TGPCR002: 38 EUR

Stránka: 374



Čistící kartáč Ribbon

TGI009: 19 EUR

Stránka 375

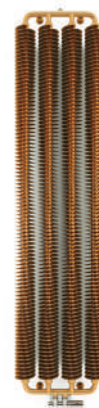

RADIÁTOR VODNÍ

Připojení:



A \updownarrow [mm]	B \leftrightarrow [mm]	75/65/20°C [W]	55/45/20°C [W]	Barvy RAL a speciální barvy Cena bez DPH [EUR]	Kód produktu ... Kód konfigurace s. 385
1720	290	660	330	869	WGRIB172029...
1720	390	872	436	1 002	WGRIB172039...
1920	390	989	499	1 056	WGRIB192039...
1920	490	1240	626	1 269	WGRIB192049...

Ribbon V E



Barva je zahrnutá v ceně



výběr připojení v ceně

DOPORUČUJEME:



Čistící kartáč Ribbon

TGI009: 19 EUR

Stránka: 375

RADIÁTOR ELEKTRICKÝ (CENA VČETNĚ NÁPLNĚ A ZVOLENÉ TOPNÉ TYČE)

Připojení:



A ⇕ [mm]	B ↔ [mm]	Výkon [W]	MEG Cena bez DPH [EUR]	MOA/DRY/ TDY Cena bez DPH [EUR] (MOA IR: +12 EUR) (MOA BLUE: +38 EUR)	ONE Cena bez DPH [EUR] (Nezabudovaná, v 8cm profilu v barvě radiátoru)	REG 2 Cena bez DPH [EUR]	REG 3 Cena bez DPH [EUR]	SIM Cena bez DPH [EUR]	Terma Split třída I Cena bez DPH [EUR] (nezapomeňte si koupit regulátor KTX)	Smart Split třída I Cena bez DPH [EUR] (nezapomeňte si koupit SMART Wi-Fi regulátor VEO)	Kód produktu ... Kód konfigurace s. 388
1800	290	600	709	716	736	687	697	677	662	662	WLRVE180029...
1800	390	800	878	885	905	855	865	846	831	831	WLRVE180039...
1800	490	1000	1016	1024	1044	994	1004	984	970	970	WLRVE180049...

Ribbon HSD



Barva je zahrnuta v ceně



výběr připojení v ceně

DOPORUČUJEME PRO PŘIPOJENÍ YL i YP:



Sada krycí integrovaná, Chrom

TGPCR002: 38 EUR

Stránka: 374



Integrovaná sada termostatická, Chrom

WRZT5G3-CR: 146 EUR

WRZT5G4-CR: 146 EUR

Stránka: 332



Čistící kartáč Ribbon

TGI009: 19 EUR

Stránka: 375

RADIÁTOR VODNÍ

Připojení:



A ↕ [mm]	B ↔ [mm]	75/65/20°C [W]	55/45/20°C [W]	Barvy RAL a speciální barvy Cena bez DPH [EUR]	Kód produktu ... Kód konfigurace s. 385
190	1540	1207	683	1 154	WGHSD019154...
190	1740	1364	772	1 272	WGHSD019174...
190	1940	1420	803	1 549	WGHSD019194...
290	1540	1609	909	1 627	WGHSD029154...
290	1740	1818	1028	1 746	WGHSD029174...
290	1940	2027	1146	1 944	WGHSD029194...

Ribbon HWS



Barva je zahrnuta v ceně



výběr připojení v ceně

DOPORUČUJEME PRO PŘIPOJENÍ VP i VL:



Sada krycí integrovaná, Chrom

TGPCR002: 38 EUR

Stránka: 374



Integrovaná sada uzavírací, Chrom

WRZOSSC1-CR: 116 EUR

Stránka: 335



Čistící kartáč Ribbon

TGI009: 19 EUR

Stránka: 375

RADIÁTOR VODNÍ

Připojení:



A ↕ [mm]	B ↔ [mm]	75/65/20°C [W]	55/45/20°C [W]	Barvy RAL a speciální barvy Cena bez DPH [EUR]	Kód produktu ... Kód konfigurace s. 385
290	1540	802	411	903	WGHWS029154...
290	1740	906	464	940	WGHWS029174...
290	1940	1010	517	1 053	WGHWS029194...
390	1540	990	504	1 090	WGHWS039154...
390	1740	1119	570	1 165	WGHWS039174...
390	1940	1248	636	1 315	WGHWS039194...
490	1540	1329	670	1 352	WGHWS049154...
490	1740	1501	757	1 464	WGHWS049174...
490	1940	1673	844	1 614	WGHWS049194...

Rolo Hanger





 Barva je zahrnuta v ceně výběr připojení v ceně

DOPORUČUJEME PRO PŘIPOJENÍ SX:



Sada tříosová termostatická, Chrom

  WRZTCG1-CR: 143EUR

  WRZTCG2-CR: 143EUR

Stránka: 330



Sada krycí dvojitá, Chrom

TGPCR001: 27EUR

Stránka: 373



RADIÁTOR VODNÍ / VODNĚ-ELEKTRICKÝ (DOKOUPIT TOPNOU TYČ)

Připojení:



A \updownarrow [mm]	B \leftrightarrow [mm]	75/65/20°C [W]	55/45/20°C [W]	 [W]	Barvy RAL a speciální barvy Cena bez DPH [EUR]	Kód produktu ... Kód konfigurace s. 385
1200	95	162	82	200	190	WGROW120009...
1200	150	242	122	300	224	WGROW120015...
1200	205	323	163	300	258	WGROW120020...
1200	260	404	204	400	278	WGROW120026...
1200	370	565	285	600	363	WGROW120037...
1200	480	726	366	800	427	WGROW120048...
1200	590	888	447	800	486	WGROW120059...
1800	95	237	118	300	222	WGROW180009...
1800	150	356	177	400	264	WGROW180015...
1800	205	474	235	600	306	WGROW180020...
1800	260	573	284	600	339	WGROW180026...
1800	370	802	398	800	444	WGROW180037...
1800	480	1031	512	1000	528	WGROW180048...
1800	590	1260	625	1200	599	WGROW180059...

Rolo Hanger E



Barva je zahrnuta v ceně



výběr připojení v ceně

RADIÁTOR ELEKTRICKÝ (CENA VČETNĚ NÁPLNĚ A ZVOLENÉ TOPNÉ TYČE)

Připojení:



A ↕ [mm]	B ↔ [mm]	Výkon [W]	MEG Cena bez DPH [EUR]	MOA/DRY/ TDY Cena bez DPH [EUR] (MOA IR: +12 EUR) (MOA BLUE: +38 EUR)	ONE Cena bez DPH [EUR] (Nezabudovaná, v 8cm profilu v barvě radiátoru)	REG 2 Cena bez DPH [EUR]	REG 3 Cena bez DPH [EUR]	SIM Cena bez DPH [EUR]	Terma Split třída I Cena bez DPH [EUR] (nezapomeňte si koupit regulátor KTX)	Smart Split třída I Cena bez DPH [EUR] (nezapomeňte si koupit SMART Wi-Fi regulátor VEO)	Kód produktu ... Kód konfigurace s. 388
1200	95	200	285	292	312	263	273	253	238	238	WLROW120009...
1200	150	300	319	326	346	297	307	287	272	272	WLROW120015...
1200	205	300	353	360	380	331	341	321	306	306	WLROW120020...
1200	260	400	373	380	400	351	361	341	326	326	WLROW120026...
1200	370	600	458	465	485	436	446	426	411	411	WLROW120037...
1200	480	800	522	529	549	500	510	490	475	475	WLROW120048...
1200	590	800	581	588	608	559	569	549	534	534	WLROW120059...
1800	95	300	317	324	344	295	305	285	270	270	WLROW180009...
1800	150	400	359	366	386	337	347	327	312	312	WLROW180015...
1800	205	600	401	408	428	379	389	369	354	354	WLROW180020...
1800	260	600	434	441	461	412	422	402	387	387	WLROW180026...
1800	370	800	539	546	566	517	527	507	492	492	WLROW180037...
1800	480	1000	623	630	650	601	611	591	576	576	WLROW180048...
1800	590	1200	694	701	721	672	682	662	647	647	WLROW180059...

Rolo Mirror



 Barva je zahrnuta v ceně
 výběr připojení v ceně

DOPORUČUJEME PRO PŘIPOJENÍ SX:



Sada tříosová termostatická, Chrom

  WRZTCG1-CR: 143EUR

  WRZTCG2-CR: 143EUR

Stránka: 330



Sada krycí dvojitá, Chrom

TGPCR001: 27EUR

Stránka: 373

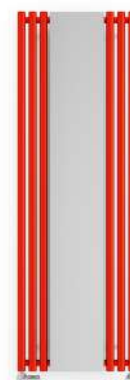

RADIÁTOR VODNÍ / VODNĚ-ELEKTRICKÝ (DOKOUPIT TOPNOU TYČ)

Připojení:



A ↕ [mm]	B ↔ [mm]	75/65/20°C [W]	55/45/20°C [W]	 [W]	Barvy RAL a speciální barvy Cena bez DPH [EUR]	Kód produktu ... Kód konfigurace s. 385
1800	480	611	320	600	479	WGROM180048...
1800	590	837	428	800	550	WGROM180059...
1800	700	1058	538	1000	619	WGROM180070...

Rolo Mirror E



Barva je zahrnuta v ceně



výběr připojení v ceně

RADIÁTOR ELEKTRICKÝ (CENA VČETNĚ NÁPLNĚ A ZVOLENÉ TOPNÉ TYČE)

Připojení:



A ↕ [mm]	B ↔ [mm]	Výkon [W]	MEG Cena bez DPH [EUR]	MOA/DRY/ TDY Cena bez DPH [EUR] (MOAIR: + 12 EUR) (MOABLUE: + 38 EUR)	ONE Cena bez DPH [EUR] (Nezabudovaná, v 8cm profilu v barvě radiátoru)	REG 2 Cena bez DPH [EUR]	REG 3 Cena bez DPH [EUR]	SIM Cena bez DPH [EUR]	Terma Split třída I Cena bez DPH [EUR] (nezapomeňte si koupit regulátor KTX)	Smart Split třída I Cena bez DPH [EUR] (nezapomeňte si koupit SMART Wi-Fi regulátor VEO)	Kod produktu ... Kód konfigurace s.388
1800	480	600	574	581	601	552	562	542	527	527	WLROM180048...
1800	590	800	645	652	672	623	633	613	598	598	WLROM180059...
1800	700	1000	714	721	741	692	702	682	667	667	WLROM180070...

Rolo Room



Barva je zahrnuta v ceně

výběr připojení v ceně

DOPORUČUJEME PRO PŘIPOJENÍ SX:



Sada tříosová termostatická, Chrom

WRZTCG1-CR: 143EUR

WRZTCG2-CR: 143EUR

Stránka: 330



Sada krycí dvojitá, Chrom

TGPCR001: 27EUR

Stránka: 373

RADIÁTOR VODNÍ / VODNĚ-ELEKTRICKÝ (DOKOUPIT TOPNOU TYČ)

Připojení:



A ↑ [mm]	B ↔ [mm]	75/65/20°C [W]	55/45/20°C [W]	[W]	Barvy RAL a speciální barvy Cena bez DPH [EUR]	Kód produktu ... Kód konfigurace s. 385
500	865	591	310	600	409	WGROR050086...
500	1195	812	426	800	553	WGROR050119...
500	1470	997	523	1000	614	WGROR050147...
580	865	672	334	800	434	WGROR058086...
580	1195	924	459	1000	545	WGROR058119...
580	1470	1134	563	1200	665	WGROR058147...
1200	260	404	204	400	269	WGROR120026...
1200	370	565	285	600	354	WGROR120037...
1200	480	726	366	800	418	WGROR120048...
1200	590	888	447	800	477	WGROR120059...
1800	260	573	284	600	330	WGROR180026...
1800	370	802	398	800	435	WGROR180037...
1800	480	1031	512	1000	519	WGROR180048...
1800	590	1260	625	1200	590	WGROR180059...



Rolo Room E



Barva je zahrnuta v ceně



výběr připojení v ceně

RADIÁTOR ELEKTRICKÝ (CENA VČETNĚ NÁPLNĚ A ZVOLENÉ TOPNÉ TYČE)

Připojení:

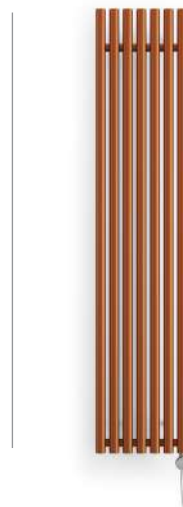

A ↕ [mm]	B ↔ [mm]	Výkon [W]	MEG Cena bez DPH [EUR]	MOA/DRY/ TDY Cena bez DPH [EUR] (MOA IR: +12 EUR) (MOA BLUE: +38 EUR)	ONE Cena bez DPH [EUR] (Nezabudovaná, v 8cm profilu v barvě radiátoru)	REG 2 Cena bez DPH [EUR]	REG 3 Cena bez DPH [EUR]	SIM Cena bez DPH [EUR]	Terma Split třída I Cena bez DPH [EUR] (nezapomeňte si koupit regulátor KTX)	Smart Split třída I Cena bez DPH [EUR] (nezapomeňte si koupit SMART WI-FI regulátor VEO)	Kód produktu ... Kód konfigurace s. 388
1200	260	400	330	336	374	311	319	302	289	289	WLROR120026...
1200	370	600	415	421	459	396	404	387	374	374	WLROR120037...
1800	260	600	391	397	435	372	380	363	350	350	WLROR180026...
1800	370	800	496	502	540	477	485	468	455	455	WLROR180037...
1800	480	1000	580	586	624	561	569	552	539	539	WLROR180048...
1800	590	1200	651	657	–	632	640	623	–	608	WLROR180059...

Rolo Room H



Barva je zahrnuta v ceně



výběr připojení v ceně

DOPORUČUJEME PRO PŘIPOJENÍ SX:



Sada třísová termostatická, Chrom

WRZTCG1-CR: 143EUR

WRZTCG2-CR: 143EUR

Stránka: 330



Sada krycí dvojité, Chrom

TGPCR001: 27EUR

Stránka: 373



RADIÁTOR VODNÍ

Připojení:



A \updownarrow [mm]	B \leftrightarrow [mm]	75/65/20°C [W]	55/45/20°C [W]	Barvy RAL a speciální barvy Cena bez DPH [EUR]	Kód produktu ... Kód konfigurace s. 385
260	1200	386	207	269	WGROH026120...
260	1800	579	311	330	WGROH026180...
370	1200	554	300	354	WGROH037120...
370	1800	831	451	435	WGROH037180...
480	1200	703	386	418	WGROH048120...
480	1800	1055	579	519	WGROH048180...
590	1200	832	463	477	WGROH059120...
590	1800	1247	693	590	WGROH059180...

Rolo Towel



Barva je zahrnuta v ceně

výběr připojení v ceně

DOPORUČUJEME PRO PŘIPOJENÍ SX:



Sada tříosová termostatická, Chrom

WRZTCG1-CR: 143EUR

WRZTCG2-CR: 143EUR

Stránka: 330



Sada krycí dvojitá, Chrom

TGPCR001: 27EUR

Stránka: 373

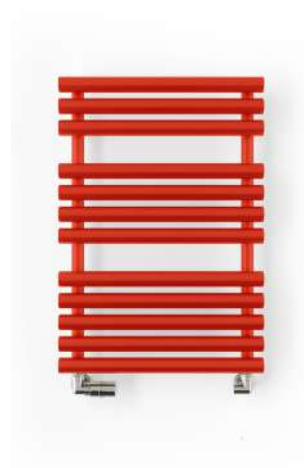

RADIÁTOR VODNÍ / VODNĚ-ELEKTRICKÝ (DOKOUPIT TOPNOU TYČ)

Připojení:



A ↕ [mm]	B ↔ [mm]	75/65/20°C [W]	55/45/20°C [W]	[W]	Barvy RAL a speciální barvy Cena bez DPH [EUR]	Kód produktu ... Kód konfigurace s. 385
590	900	587	321	600	345	WGROT059090...
755	520	467	252	400	318	WGROT075052...
1085	520	619	333	600	406	WGROT108052...
1360	520	771	412	800	493	WGROT136052...
1580	520	892	474	1000	561	WGROT158052...
1800	520	1013	536	1000	621	WGROT180052...

Rolo Towel E



Barva je zahrnuta v ceně



výběr připojení v ceně

RADIÁTOR ELEKTRICKÝ (CENA VČETNĚ NÁPLNĚ A ZVOLENÉ TOPNÉ TYČE)

Připojení:



A ↕ [mm]	B ↔ [mm]	Výkon [W]	MEG Cena bez DPH [EUR]	MOA/DRY/ TDY Cena bez DPH [EUR] (MOAIR: + 12 EUR) (MOABLUE: + 38 EUR)	ONE Cena bez DPH [EUR] (Nezabudovaná, v 8cm profilu v barvě radiátoru)	REG 2 Cena bez DPH [EUR]	REG 3 Cena bez DPH [EUR]	SIM Cena bez DPH [EUR]	Terma Split třída I Cena bez DPH [EUR] (nezapomeňte si koupit regulátor KTX)	Smart Split třída I Cena bez DPH [EUR] (nezapomeňte si koupit SMART Wi-Fi regulátor VEO)	Kód produktu ... Kód konfigurace s. 388
755	520	400	413	420	440	391	401	381	366	366	WLROT075052...
1085	520	600	501	508	528	479	489	469	454	454	WLROT108052...
1360	520	800	588	595	615	566	576	556	541	541	WLROT136052...
1580	520	1000	656	663	683	634	644	624	609	609	WLROT158052...
1800	520	1000	716	723	743	694	704	684	669	669	WLROT180052...

Sherwood H



Barva je zahrnuta v ceně



výběr připojení v ceně

DOPORUČUJEME PRO PŘIPOJENÍ O1 i O8:



Sada krycí integrovaná, Chrom

TGPCR002: 38 EUR

Stránka: 374



Integrovaná sada termostatická s ponornou trubicí, Chrom

WRZT5G5-CR: 151 EUR

WRZT5G6-CR: 151 EUR

Stránka: 334



RADIÁTOR VODNÍ:

Připojení:

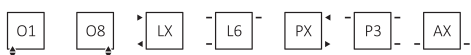

A \updownarrow [mm]	B \leftrightarrow [mm]	75/65/20°C [W]	55/45/20°C [W]	Barvy RAL a speciální barvy Cena bez DPH [EUR]	Kód produktu ... Kód konfigurace s. 385
330	1000	429	222	598	WGSTH033100...
330	1300	558	289	673	WGSTH033130...
330	1600	687	356	768	WGSTH033160...
330	1900	816	422	900	WGSTH033190...
440	1300	701	364	750	WGSTH044130...
440	1600	863	448	843	WGSTH044160...
440	1900	1025	532	975	WGSTH044190...
540	1600	1057	557	937	WGSTH054160...
540	1900	1255	661	1 069	WGSTH054190...

Sherwood V



Barva je zahrnuta v ceně

výběr připojení v ceně

DOPORUČUJEME PRO PŘIPOJENÍ Z1, Z8 i ZX:



Sada krycí integrovaná, Chrom

TGPCR002: 38 EUR

Stránka: 374



Háček bodový KUKA 50, Chrom

WRWKUK001 KCRO: 44 EUR

Stránka: 315



Integrovaná sada termostatická,

Chrom

WRZT5G1-CR: 145 EUR

WRZT5G2-CR: 145 EUR

Stránka: 332



RADIÁTOR VODNÍ / VODNĚ-ELEKTRICKÝ (DOKOUPIT TOPNOU TYČ)

Připojení:



A ↕ [mm]	B ↔ [mm]	75/65/20°C [W]	55/45/20°C [W]	 [W]	Barvy RAL a speciální barvy Cena bez DPH [EUR]	Kód produktu ... Kód konfigurace s. 385
1000	330	478	242	600	603	WGSTV100033...
1300	330	602	303	600	681	WGSTV130033...
1300	440	803	404	800	779	WGSTV130044...
1600	330	727	365	800	759	WGSTV160033...
1600	440	969	486	1000	857	WGSTV160044...
1600	540	1190	597	1200	916	WGSTV160054...
1900	330	851	427	800	955	WGSTV190033...
1900	440	1135	569	1200	994	WGSTV190044...
1900	540	1393	698	1500	1 093	WGSTV190054...

Sherwood V E



Barva je zahrnuta v ceně



výběr připojení v ceně

RADIÁTOR ELEKTRICKÝ (CENA VČETNĚ NÁPLNĚ A ZVOLENÉ TOPNÉ TYČE)

Připojení:

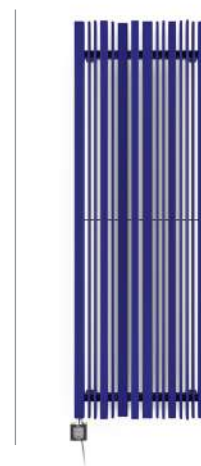

A ↕ [mm]	B ↔ [mm]	Výkon [W]	MEG Cena bez DPH [EUR]	MOA/DRY/ TDY Cena bez DPH [EUR] (MOAIR: +12 EUR) (MOA BLUE: + 38 EUR)	ONE Cena bez DPH [EUR] (Nezabudovaná, v 8cm profilu v barvě radiátoru)	REG 2 Cena bez DPH [EUR]	REG 3 Cena bez DPH [EUR]	SIM Cena bez DPH [EUR]	Terma Split třída I Cena bez DPH [EUR] (nezapomeňte si koupit regulátor KTX)	Smart Split třída I Cena bez DPH [EUR] (nezapomeňte si koupit SMART Wi-Fi regulátor VEO)	Kód produktu ... Kód konfigurace s. 388
1000	330	600	708	716	736	686	696	677	662	662	WLSTV100033...
1300	330	600	788	796	815	766	776	756	742	742	WLSTV130033...
1300	440	800	888	896	915	866	876	856	841	841	WLSTV130044...
1600	330	800	868	875	895	846	856	836	821	821	WLSTV160033...
1600	440	1000	968	975	995	946	956	936	921	921	WLSTV160044...
1600	540	1200	1028	1035	–	1005	1015	996	–	981	WLSTV160054...
1900	330	800	1067	1075	1095	1045	1055	1036	1021	1021	WLSTV190033...
1900	440	1200	1107	1115	–	1085	1095	1075	–	1060	WLSTV190044...
1900	540	1500	–	–	–	–	–	1176	–	1161	WLSTV190054...

Simple



DOPORUČUJEME PRO PŘIPOJENÍ SX:



Sada tříosová termostatická, Chrom

WRZTCG1-CR: 143EUR

WRZTCG2-CR: 143EUR

Stránka: 330



Sada krycí dvojitá, Chrom

TGPCR001: 27EUR

Stránka: 373



Police SIMPLE - Masivní dřevo

WRPSIM050 KBUK: 50EUR (BUK)

WRPSIM050 KDAB: 56EUR (DUB)

WRPSIM050 KTEK: 118EUR (TEAK)

Stránka: 309



RADIÁTOR VODNÍ / VODNĚ-ELEKTRICKÝ (DOKOUPIT TOPNOU TYČ)

Připojení:

Výška [mm] 480÷1920:



Výška [mm] 720÷1920:

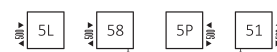

A ↕ [mm]	B ↔ [mm]	Barva ze vzorníku RAL a speciálních barev			Galvanický povrch Chrom			Barvy RAL a speciální barvy Cena bez DPH [EUR]	Chrom Cena bez DPH [EUR]	Kód produktu ... Kód konfigurace s. 385
		75/65/20°C [W]	55/45/20°C [W]	[W]	75/65/20°C [W]	55/45/20°C [W]	[W]			
480	500	173	100	200	121	70	120	232	350	WGSIM048050...
600	500	217	123	200	152	86	120	260	396	WGSIM060050...
720	500	262	145	300	183	102	200	274	435	WGSIM072050...
840	500	306	167	300	214	117	200	289	487	WGSIM084050...
960	500	351	189	400	246	132	300	302	533	WGSIM096050...
1080	500	396	211	400	277	148	300	317	579	WGSIM108050...
1200	500	440	234	400	308	164	300	345	625	WGSIM120050...
1440	500	529	271	600	370	190	400	373	737	WGSIM144050...
1680	500	618	308	600	433	216	400	430	822	WGSIM168050...
1920	500	707	343	800	–	–	–	458	–	WGSIM192050...

Simple E



Barva je zahrnuta v ceně



výběr připojení v ceně

RADIÁTOR ELEKTRICKÝ (CENA VČETNĚ NÁPLNĚ A ZVOLENÉ TOPNÉ TYČE)

Připojení:



A ↕ [mm]	B ↔ [mm]	Výkon [W]		MEG Cena bez DPH [EUR]		MOA/DRY/TDY Cena bez DPH [EUR] (MOAIR: +12 EUR) (MOABLUE: +38 EUR)		ONE Cena bez DPH [EUR] (Nezabudovaná, v 8cm profilu v barvě radiátoru)		REG 2 Cena bez DPH [EUR]		REG 3 Cena bez DPH [EUR]		SIM Cena bez DPH [EUR]		Terma Split třída I Cena bez DPH [EUR] (nezapomeňte si koupit regulátor KTX)		Smart Split třída I Cena bez DPH [EUR] (nezapomeňte si koupit SMARTWi-Fi regulátor VEO)		Kód produktu ... Kód konfigurace s.388
				Barva	Chrom	Barvy RAL a speciální barvy	Chrom	Barvy RAL a speciální barvy	Chrom	Barvy RAL a speciální barvy	Chrom	Barvy RAL a speciální barvy	Chrom	Barvy RAL a speciální barvy	Chrom	Barvy RAL a speciální barvy	Chrom	Barvy RAL a speciální barvy	Chrom	
480	500	200	120	325	445	333	452	352	472	303	423	313	432	293	413	279	398	279	398	WLSIM048050...
600	500	200	120	355	490	362	498	382	517	333	468	343	478	323	458	308	443	308	443	WLSIM060050...
720	500	300	200	368	530	376	537	396	557	346	507	356	517	336	498	322	483	322	483	WLSIM072050...
840	500	300	200	383	581	391	589	410	608	361	559	371	569	351	549	336	534	336	534	WLSIM084050...
960	500	400	300	397	628	404	635	424	655	375	606	384	616	365	596	350	581	350	581	WLSIM096050...
1080	500	400	300	412	673	419	681	439	700	389	651	399	661	380	641	365	627	365	627	WLSIM108050...
1200	500	400	300	440	719	447	726	467	746	418	697	427	707	408	687	393	672	393	672	WLSIM120050...
1440	500	600	400	468	832	475	839	495	859	446	810	456	820	436	800	421	785	421	785	WLSIM144050...
1680	500	600	400	525	917	532	924	552	944	502	895	512	905	493	885	478	870	478	870	WLSIM168050...
1920	500	800	-	553	-	560	-	580	-	531	-	541	-	521	-	506	-	506	-	WLSIM192050...

Simple One



Barva je zahrnuta v ceně



výběr připojení v ceně



TŘÍDA I



45-60°C/2



P-W-U



120-1000W



IR



IPx5



2h/1



SADA OBSAHUJE:

Radiátor se zabudovanou topnou tyčí One. Funkce topné tyče ONE: Stránka 287.

DOPORUČUJEME PRO PŘIPOJENÍ S1 i S8:



Integrovaná sada termostatická s ponornou trubicí, Chrom

WRZT5G5-CR: 151EUR

WRZT5G6-CR: 151EUR

Stránka: 334



Sada krycí integrovaná, Chrom

TGPCR002: 38 EUR

Stránka: 374



Police SIMPLE - Masivní dřevo

WRPSIM050 KBUK: 50 EUR (BUK)

WRPSIM050 KDAB: 56 EUR (DUB)

WRPSIM050 KTEK: 118 EUR (TEAK)

Stránka: 309



RADIÁTOR VODNĚ-ELEKTRICKÝ (CENA VČETNĚ ZABUDOVANÉ TOPNÉ TYČE ONE)

Připojení:

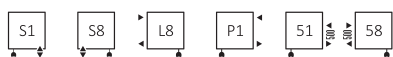

Vyber druh kabelu:

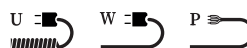

A ↓ [mm]	B ↔ [mm]	Barva ze vzorníku RAL a speciálních barev			Galvanický povrch Chrom			Barvy RAL a speciální barvy Cena bez DPH [EUR]	Chrom Cena bez DPH [EUR]	Kód produktu ... Kód konfigurace s. 386
		75/65/20°C [W]	55/45/20°C [W]	[W]	75/65/20°C [W]	55/45/20°C [W]	[W]			
720	500	262	145	300	183	102	200	371	532	WZSIE072050...
840	500	306	167	300	214	117	200	386	584	WZSIE084050...
960	500	351	189	400	246	132	300	399	630	WZSIE096050...
1080	500	396	211	400	277	148	300	414	676	WZSIE108050...
1200	500	440	234	400	308	164	300	442	721	WZSIE120050...
1440	500	529	271	600	370	190	400	471	834	WZSIE144050...
1680	500	618	308	600	433	216	400	527	919	WZSIE168050...
1920	500	707	343	800	-	-	-	555	-	WZSIE192050...

Simple One E



Barva je zahrnuta v ceně



výběr připojení v ceně



TŘÍDA I



45-60°C/2



P-W-U



120-1000W



IR



IPx5



2h/1



RADIÁTOR ELEKTRICKÝ (CENA VČETNĚ NÁPLNĚ A ZABUDOVANÉ TOPNÉ TYČE ONE)

Připojení:



A ↕ [mm]	B ↔ [mm]	Výkon [W]		Barvy RAL a speciální barvy Cena bez DPH [EUR]	Chrom Cena bez DPH [EUR]	Kód produktu ... Kód konfigurace s. 387
		Barva	Chrom			
720	500	300	200	389	550	WWSIE072050...
840	500	300	200	404	602	WWSIE084050...
960	500	400	300	418	649	WWSIE096050...
1080	500	400	300	432	694	WWSIE108050...
1200	500	400	300	461	740	WWSIE120050...
1440	500	600	400	489	853	WWSIE144050...
1680	500	600	400	546	938	WWSIE168050...
1920	500	800	-	574	-	WWSIE192050...

Simple DW (dělicí stěna kolmá)



Barva je zahrnuta v ceně

výběr připojení v ceně

DOPORUČUJEME PRO PŘIPOJENÍ ZX i Z1:



Integrovaná sada termostatická ventil přímý, Chrom

WRZT5G3-CR: 146 EUR

WRZT5G4-CR: 146 EUR

Stránka: 332



Sada krycí integrovaná, Chrom

TGPCR002: 38 EUR

Stránka: 374



Police SIMPLE - Masivní dřevo

WRPSIM050 KBUK: 50 EUR (BUK)

WRPSIM050 KDAB: 56 EUR (DUB)

WRPSIM050 KTEK: 118 EUR (TEAK)

Stránka: 309



RADIÁTOR VODNÍ / VODNĚ-ELEKTRICKÝ (DOKOUPIT TOPNOU TYČ)

Připojení:



A ↕ [mm]	B ↔ [mm]	75/65/20°C [W]	55/45/20°C [W]	[W]	Barvy RAL a speciální barvy Cena bez DPH [EUR]	Kód produktu ... Kód konfigurace s. 385
1515	500	529	271	600	448	WGSDW151050...
1755	500	618	308	600	478	WGSDW175050...
1995	500	707	343	800	507	WGSDW199050...

Simple DW E



Barva je zahrnuta v ceně



výběr připojení v ceně

RADIÁTOR ELEKTRICKÝ (CENA VČETNĚ VYHŘÍVÁNÍ TOPNÝM KABLEM)

Připojení:

E1

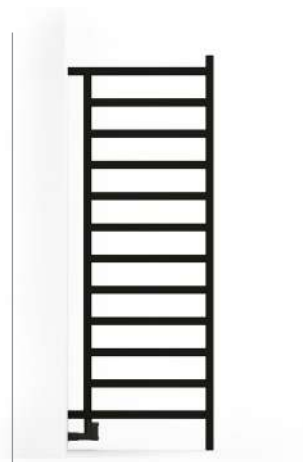

A ↕ [mm]	B ↔ [mm]	Výkon [W]	MEG Cena bez DPH [EUR]	MOA/DRY/ TDY Cena bez DPH [EUR] (MOAIR: +12 EUR) (MOA BLUE: +38 EUR)	ONE Cena bez DPH [EUR] (Nezabudovaná, v 8cm profilu v barvě radiátoru)	REG 2 Cena bez DPH [EUR]	REG 3 Cena bez DPH [EUR]	SIM Cena bez DPH [EUR]	Terma Split třída I Cena bez DPH [EUR] (nezapomeňte si koupit regulátor KTX)	Smart Split třída I Cena bez DPH [EUR] (nezapomeňte si koupit SMART Wi-Fi regulátor VEO)	Kód produktu ... Kód konfigurace s. 388
1515	500	600	543	550	570	521	531	511	496	496	WLSDW151050...
1755	500	600	573	580	600	550	560	541	526	526	WLSDW175050...
1995	500	800	602	609	629	580	590	570	555	555	WLSDW199050...

RADIÁTOR ELEKTRICKÝ (CENA VČETNĚ VYHŘÍVÁNÍ TOPNÝM KABLEM)

Připojení:



Vyber druh kabelu:

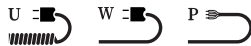

A ↕ [mm]	B ↔ [mm]	Výkon [W]		Barvy RAL a speciální barvy Cena bez DPH [EUR]	Chrom Cena bez DPH [EUR]	Kód produktu ... Kód konfigurace s. 389
		Barva	Chrom			
566	450	110	80	231	347	WSSPI056045...
794	450	165	110	252	406	WSSPI079045...
1062	450	205	130	273	465	WSSPI106045...

* Radiátor s topným kabelem v celém těle. Druh kabelu zvolte W, P nebo U. Viz Legenda Druhů kabelů. Stránka 284

Stand



Barva je zahrnuta v ceně

výběr připojení v ceně

DOPORUČUJEME PRO PŘIPOJENÍ SX:



Sada tříosová termostatická, Chrom

WRZTCG1-CR: 143EUR

WRZTCG2-CR: 143EUR

Stránka: 330



Sada krycí dvojitá, Chrom

TGPCR001: 27EUR

Stránka: 373



Police STAND - Masivní dřevo

WRPSCA050 KBUK: EUR 48 (BUK)

WRPSCA050 KDAB: EUR 65 (DUB)

WRPSCA050 KTEK: EUR 176 (TEAK)

Stránka: 310



RADIÁTOR VODNÍ / VODNĚ-ELEKTRICKÝ (DOKOUPIT TOPNOU TYČ)

Připojení:



A ↕ [mm]	B ↔ [mm]	75/65/20°C [W]	55/45/20°C [W]	[W]	Barvy RAL a speciální barvy Cena bez DPH [EUR]	Kód produktu ... Kód konfigurace s. 385
920	300	383	207	400	365	WGSCA092030...
920	400	434	234	400	376	WGSCA092040...
920	500	486	262	600	388	WGSCA092050...
1150	300	480	259	400	387	WGSCA115030...
1150	400	547	295	600	402	WGSCA115040...
1150	500	615	331	600	416	WGSCA115050...
1380	300	577	310	600	417	WGSCA138030...
1380	400	660	355	600	434	WGSCA138040...
1380	500	743	399	800	451	WGSCA138050...
1610	300	674	362	800	438	WGSCA161030...
1610	400	773	415	800	456	WGSCA161040...
1610	500	872	468	800	475	WGSCA161050...

Stand E



Barva je zahrnuta v ceně



výběr připojení v ceně

DOPORUČUJEME PRO PŘIPOJENÍ E1 i E8:



Police STAND - Masivní dřevo
WRPSCA030 KBUK: EUR 43 (BUK)
WRPSCA030 KDAB: EUR 58 (DUB)
WRPSCA030 KTEK: EUR 126 (TEAK)
Stránka: 310

Police STAND - Masivní dřevo
WRPSCA040 KBUK: EUR 45 (BUK)
WRPSCA040 KDAB: EUR 62 (DUB)
WRPSCA040 KTEK: EUR 144 (TEAK)
Stránka: 310

Police STAND - Masivní dřevo
WRPSCA050 KBUK: EUR 48 (BUK)
WRPSCA050 KDAB: EUR 65 (DUB)
WRPSCA050 KTEK: EUR 176 (TEAK)
Stránka: 310



RADIÁTOR ELEKTRICKÝ (CENA VČETNĚ NÁPLNĚ A ZVOLENÉ TOPNÉ TYČE)

Připojení:

E1

E8

A ↕ [mm]	B ↔ [mm]	Výkon [W]	MEG Cena bez DPH [EUR]	MOA/DRY/ TDY Cena bez DPH [EUR] (MOAIR: +12 EUR) (MOABLUE: +38 EUR)	ONE Cena bez DPH [EUR] (Nezabudovaná, v 8cm profilu v barvě radiátoru)	REG 2 Cena bez DPH [EUR]	REG 3 Cena bez DPH [EUR]	SIM Cena bez DPH [EUR]	Terma Split třída I Cena bez DPH [EUR] (nezapomeňte si koupit regulátor KTX)	Smart Split třída I Cena bez DPH [EUR] (nezapomeňte si koupit SMART Wi-Fi regulátor VEO)	Kód produktu ... Kód konfigurace s. 388
920	300	300	460	467	487	438	447	428	413	413	WLSCA092030...
920	400	400	471	478	498	449	459	439	424	424	WLSCA092040...
920	500	400	482	490	510	460	470	450	436	436	WLSCA092050...
1150	300	400	482	489	509	460	470	450	435	435	WLSCA115030...
1150	400	400	496	504	523	474	484	464	450	450	WLSCA115040...
1150	500	600	510	518	537	488	498	478	464	464	WLSCA115050...
1380	300	400	512	519	539	490	499	480	465	465	WLSCA138030...
1380	400	600	529	536	556	507	517	497	482	482	WLSCA138040...
1380	500	600	546	553	573	524	534	514	499	499	WLSCA138050...
1610	300	600	532	540	559	510	520	500	486	486	WLSCA161030...
1610	400	600	550	558	578	528	538	519	504	504	WLSCA161040...
1610	500	800	570	577	597	548	558	538	523	523	WLSCA161050...

Step



Barva je zahrnuta v ceně

výběr připojení v ceně

DOPORUČUJEME PRO PŘIPOJENÍ SX:



Sada tříosová termostatická, Chrom

WRZTCG1-CR: 143EUR

WRZTCG2-CR: 143EUR

Stránka: 330



Sada krycí dvojitá, Chrom

TGPCR001: 27EUR

Stránka: 373



RADIÁTOR VODNÍ / VODNĚ-ELEKTRICKÝ (DOKOUPIT TOPNOU TYČ)

Připojení:



A ↑ [mm]	B ↔ [mm]	75/65/20°C [W]	55/45/20°C [W]	 [W]	Barvy RAL a speciální barvy Cena bez DPH [EUR]	Kód produktu ... Kód konfigurace s. 385
380	400	118	64	–	154	WGSTP038040...
380	500	135	74	–	159	WGSTP038050...
380	600	154	84	–	163	WGSTP038060...
700	400	223	121	200	183	WGSTP070040...
700	500	255	138	300	191	WGSTP070050...
700	600	291	157	300	198	WGSTP070060...
1020	400	327	175	300	205	WGSTP102040...
1020	500	374	200	400	217	WGSTP102050...
1020	600	428	229	400	228	WGSTP102060...
1340	400	432	230	400	231	WGSTP134040...
1340	500	494	264	600	244	WGSTP134050...
1340	600	565	301	600	259	WGSTP134060...
1660	400	536	285	600	256	WGSTP166040...
1660	500	613	326	600	274	WGSTP166050...
1660	600	702	373	800	292	WGSTP166060...

Step E



Barva je zahrnuta v ceně



výběr připojení v ceně

RADIÁTOR ELEKTRICKÝ (CENA VČETNĚ NÁPLNĚ A ZVOLENÉ TOPNÉ TYČE)

Připojení:



A ↕ [mm]	B ↔ [mm]	Výkon [W]	MEG Cena bez DPH [EUR]	MOA/DRY/ TDY Cena bez DPH [EUR] (MOA IR: +12 EUR) (MOA BLUE: +38 EUR)	ONE Cena bez DPH [EUR] (Nezabudovaná, v 8cm profilu v barvě radiátoru)	REG 2 Cena bez DPH [EUR]	REG 3 Cena bez DPH [EUR]	SIM Cena bez DPH [EUR]	Terma Split třída I Cena bez DPH [EUR] (nezapomeňte si koupit regulátor KTX)	Smart Split třída I Cena bez DPH [EUR] (nezapomeňte si koupit SMART Wi-Fi regulátor VEO)	Kód produktu ... Kód konfigurace s. 388
700	400	200	278	285	305	256	266	246	231	231	WLSTP070040...
700	500	300	286	293	313	264	274	254	239	239	WLSTP070050...
700	600	300	293	300	320	271	281	261	246	246	WLSTP070060...
1020	400	300	300	307	327	278	288	268	253	253	WLSTP102040...
1020	500	400	312	319	339	290	300	280	265	265	WLSTP102050...
1020	600	400	323	330	350	301	311	291	276	276	WLSTP102060...
1340	400	400	326	333	353	304	314	294	279	279	WLSTP134040...
1340	500	600	339	346	366	317	327	307	292	292	WLSTP134050...
1340	600	600	354	361	381	332	342	322	307	307	WLSTP134060...
1660	400	600	351	358	378	329	339	319	304	304	WLSTP166040...
1660	500	600	369	376	396	347	357	337	322	322	WLSTP166050...
1660	600	800	387	394	414	365	375	355	340	340	WLSTP166060...



Barva je zahrnuta v ceně



výběr připojení v ceně

DOPORUČUJEME PRO PŘIPOJENÍ Z1, Z8 i ZX:



Sada krycí integrovaná, Chrom

TGPCR002: 38 EUR

[Stránka: 374](#)



Integrovaná sada termostatická,

Chrom



WRZT5G1-CR: 145 EUR



WRZT5G2-CR: 145 EUR

[Stránka: 332](#)



RADIÁTOR VODNÍ

Připojení:



A ↕ [mm]	B ↔ [mm]	75/65/20°C [W]	55/45/20°C [W]	Barvy RAL a speciální barvy Cena bez DPH [EUR]	Kód produktu ... Kód konfigurace s. 385
621	465	258	139	508	WGQ09062046...
932	465	385	205	593	WGQ09093046...
1244	465	512	269	627	WGQ09124046...
1555	465	640	332	731	WGQ09155046...



Barva je zahrnuta v ceně

výběr připojení v ceně

DOPORUČUJEME PRO PŘIPOJENÍ YL, YP, Z1, Z8 i ZX:



Integrovaná sada termostatická,

Chrom

WRZT5G1-CR: 145 EUR

WRZT5G2-CR: 145 EUR

Stránka: 332



Sada krycí integrovaná, Chrom

TGPCR002: 38 EUR

Stránka: 374



Police TRIGA - Masivní dřevo 680 mm

WRPTRG068 KBUK: 87 EUR (BUK)

WRPTRG068 KDAB: 90 EUR (DUB)

WRPTRG068 KTEK: 188 EUR (TEAK)

Stránka: 311



RADIÁTOR VODNÍ / VODNĚ-ELEKTRICKÝ (DOKOUPIT TOPNOU TYČ)

Připojení:

Výška [mm] 560÷1900:

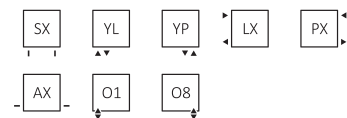

Výška [mm] 560÷610:

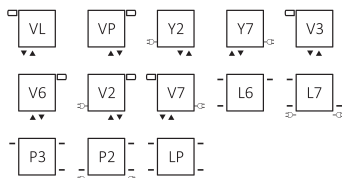

Výška [mm] 900÷1900:

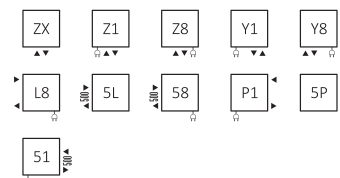

A ↕ [mm]	B ↔ [mm]	75/65/20°C [W]	55/45/20°C [W]	[W]	Barvy RAL a speciální barvy Cena bez DPH [EUR]	Kód produktu ... Kód konfigurace s. 385
560	480	356	192	400	498	WGTRG056048...
560	680	504	272	600	591	WGTRG056068...
560	880	652	352	600	684	WGTRG056088...
560	1080	800	431	800	794	WGTRG056108...
560	1280	948	511	1000	918	WGTRG056128...
610	480	391	210	400	528	WGTRG061048...
610	680	554	298	600	607	WGTRG061068...
610	880	717	385	800	684	WGTRG061088...
610	1080	880	473	800	841	WGTRG061108...
610	1280	1043	560	1000	965	WGTRG061128...
900	380	459	242	400	451	WGTRG090038...
900	480	580	306	600	528	WGTRG090048...
900	580	701	370	800	607	WGTRG090058...
900	680	821	433	800	715	WGTRG090068...
1300	380	652	339	600	544	WGTRG130038...
1300	480	824	429	800	622	WGTRG130048...
1300	580	996	518	1000	715	WGTRG130058...
1300	680	1168	608	1200	794	WGTRG130068...

Triga

A ↕ [mm]	B ↔ [mm]	75/65/20°C [W]	55/45/20°C [W]	 [W]	Barvy RAL a speciální barvy Cena bez DPH [EUR]	Kód produktu ... Kód konfigurace s. 385
1700	380	850	437	800	591	WGTRG170038...
1700	480	1074	552	1000	668	WGTRG170048...
1700	580	1298	667	1200	762	WGTRG170058...
1700	680	1521	781	1500	871	WGTRG170068...
1900	380	961	492	1000	638	WGTRG190038...
1900	480	1202	615	1200	715	WGTRG190048...
1900	580	1442	737	1500	825	WGTRG190058...
1900	680	1682	860	1500	934	WGTRG190068...

Triga E



Barva je zahrnuta v ceně



výběr připojení v ceně

DOPORUČUJEME:



Police TRIGA - Masivní dřevo 680

mm

WRPTRG068 KBUK: 87 EUR (BUK)

WRPTRG068 KDAB: 90 EUR (DUB)

WRPTRG068 KTEK: 188 EUR (TEAK)

Stránka: 311

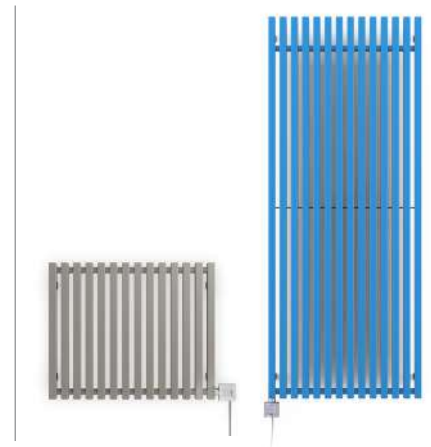

RADIÁTOR ELEKTRICKÝ (CENA VČETNĚ NÁPLNĚ A ZVOLENÉ TOPNÉ TYČE)

Připojení:

Výška [mm] 900 ÷ 1900:

Výška 560 mm ÷ 610:



A ↕ [mm]	B ↔ [mm]	Výkon [W]	MEG Cena bez DPH [EUR]	MOA/DRY/ TDY Cena bez DPH [EUR] (MOA IR: +12 EUR) (MOA BLUE: +38 EUR)	ONE Cena bez DPH [EUR] (Nezabudovaná, v 8cm profilu v barvě radiátoru)	REG 2 Cena bez DPH [EUR]	REG 3 Cena bez DPH [EUR]	SIM Cena bez DPH [EUR]	Terma Split třída I Cena bez DPH [EUR] (nezapomeňte si koupit regulátor KTX)	Smart Split třída I Cena bez DPH [EUR] (nezapomeňte si koupit SMART Wi-Fi regulátor VEO)	Kód produktu ... Kód konfigurace s. 388
560	480	400	592	600	619	570	580	560	546	546	WLTRG056048...
560	680	600	686	693	713	664	673	654	639	639	WLTRG056068...
560	880	600	779	787	806	757	767	747	732	732	WLTRG056088...
560	1080	800	889	896	916	866	876	857	842	842	WLTRG056108...
560	1280	1000	1013	1020	1040	991	1000	981	966	966	WLTRG056128...
610	480	400	623	630	650	601	611	591	576	576	WLTRG061048...
610	680	600	702	709	729	680	689	670	655	655	WLTRG061068...
610	880	800	779	787	806	757	767	747	732	732	WLTRG061088...
610	1080	800	935	943	962	913	923	903	889	889	WLTRG061108...
610	1280	1000	1060	1067	1087	1037	1047	1028	1013	1013	WLTRG061128...
900	380	400	546	553	573	523	533	514	499	499	WLTRG090038...
900	480	600	623	630	650	601	611	591	576	576	WLTRG090048...
900	580	800	702	709	729	680	689	670	655	655	WLTRG090058...
900	680	800	810	817	837	788	798	778	763	763	WLTRG090068...
1300	380	600	639	646	666	617	627	607	592	592	WLTRG130038...

Triga E

A ↕ [mm]	B ↔ [mm]	Výkon [W]	MEG Cena bez DPH [EUR]	MOA/DRY/ TDY Cena bez DPH [EUR] (MOAIR: +12 EUR) (MOABLUE: +38 EUR)	ONE Cena bez DPH [EUR] (Nezabudovaná, v 8cm profilu v barvě radiátoru)	REG 2 Cena bez DPH [EUR]	REG 3 Cena bez DPH [EUR]	SIM Cena bez DPH [EUR]	Terma Split třída I Cena bez DPH [EUR] (nezapomeňte si koupit regulátor KTX)	Smart Split třída I Cena bez DPH [EUR] (nezapomeňte si koupit SMART Wi-Fi regulátor VEO)	Kód produktu ... Kód konfigurace s. 388
1300	480	800	716	724	743	694	704	684	670	670	WLTRG130048...
1300	580	1000	810	817	837	788	798	778	763	763	WLTRG130058...
1300	680	1200	889	896	–	866	876	857	–	842	WLTRG130068...
1700	380	800	686	693	713	664	673	654	639	639	WLTRG170038...
1700	480	1000	763	771	790	741	751	731	716	716	WLTRG170048...
1700	580	1200	857	864	–	834	844	825	–	810	WLTRG170058...
1700	680	1500	–	–	–	–	–	934	–	919	WLTRG170068...
1900	380	1000	732	740	759	710	720	700	686	686	WLTRG190038...
1900	480	1200	810	817	–	788	798	778	–	763	WLTRG190048...
1900	580	1500	–	–	–	–	–	887	–	872	WLTRG190058...
1900	680	1500	–	–	–	–	–	997	–	982	WLTRG190068...

Triga AN

  Barva je zahrnuta v ceně

DOPORUČUJEME PRO PŘIPOJENÍ ZX:



Integrovaná sada termostatická,
Chrom

 WRZT5G1-CR: 145 EUR

 WRZT5G2-CR: 145 EUR

Stránka: 332



Sada krycí integrovaná, Chrom

TGPCR002: 38 EUR

Stránka: 374



RADIÁTOR VODNÍ

Připojení:



A ↕ [mm]	B ↔ [mm]	75/65/20°C [W]	55/45/20°C [W]	 [W]	Barvy RAL a speciální barvy Cena bez DPH [EUR]	Kód produktu ... Kód konfigurace s. 385
1700	280	953	492	1000	816	WGVER170028...
1900	280	1053	548	1000	878	WGVER190028...

Triga AN E



Barva je zahrnuta v ceně

RADIÁTOR ELEKTRICKÝ (CENA VČETNĚ NÁPLNĚ A ZVOLENÉ TOPNÉ TYČE)

Připojení:



A ↕ [mm]	B ↔ [mm]	Výkon [W]	MEG Cena bez DPH [EUR]	MOA/DRY/ TDY Cena bez DPH [EUR] (MOAIR: +12 EUR) (MOA BLUE: +38 EUR)	ONE Cena bez DPH [EUR] (Nezabudovaná, v 8cm profilu v barvě radiátoru)	REG 2 Cena bez DPH [EUR]	REG 3 Cena bez DPH [EUR]	SIM Cena bez DPH [EUR]	Terma Split třída I Cena bez DPH [EUR] (nezapomeňte si koupit regulátor KTX)	Smart Split třída I Cena bez DPH [EUR] (nezapomeňte si koupit SMART Wi-Fi regulátor VEO)	Kód produktu ... Kód konfigurace s. 388
1700	280	1000	911	918	938	889	898	879	864	864	WLVER170028...
1900	280	1000	972	980	999	950	960	940	925	925	WLVER190028...

Triga ANC



Barva je zahrnuta v ceně



výběr připojení v ceně

DOPORUČUJEME PRO PŘIPOJENÍ YL i YP:



Integrovaná sada termostatická,

Chrom

WRZT5G1-CR: 145 EUR

WRZT5G2-CR: 145 EUR

Stránka: 332



Sada krycí integrovaná, Chrom

TGPCR002: 38 EUR

Stránka: 374

RADIÁTOR VODNÍ:

Připojení:

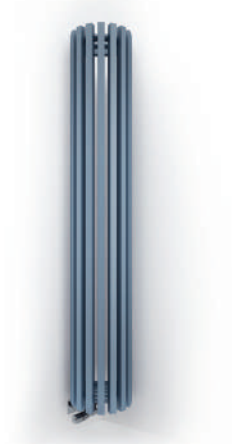

A ↕ [mm]	B ↔ [mm]	75/65/20°C [W]	55/45/20°C [W]	 [W]	Barvy RAL a speciální barvy Cena bez DPH [EUR]	Kód produktu ... Kód konfigurace s. 385
1700	280	953	492	1000	1 024	WGVEC170028...
1900	280	1053	548	1000	1 152	WGVEC190028...

Triga ANC E

 Barva je zahrnuta v ceně

RADIÁTOR ELEKTRICKÝ (CENA VČETNĚ NÁPLNĚ A ZVOLENÉ TOPNÉ TYČE)

Připojení:

EX

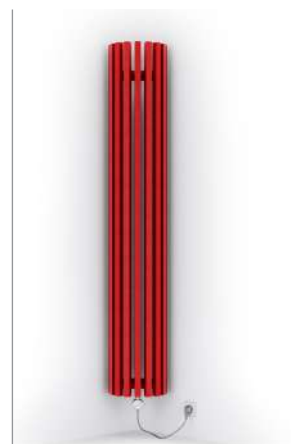

A ↕ [mm]	B ↔ [mm]	Výkon [W]	MEG Cena bez DPH [EUR]	MOA/DRY/ TDY Cena bez DPH [EUR] (MOAIR: +12 EUR) (MOA BLUE: +38 EUR)	ONE Cena bez DPH [EUR] (Nezabudovaná, v 8cm profilu v barvě radiátoru)	REG 2 Cena bez DPH [EUR]	REG 3 Cena bez DPH [EUR]	SIM Cena bez DPH [EUR]	Terma Split třída I Cena bez DPH [EUR] (nezapomeňte si koupit regulátor KTX)	Smart Split třída I Cena bez DPH [EUR] (nezapomeňte si koupit SMART Wi-Fi regulátor VEO)	Kód produktu ... Kód konfigurace s. 388
1700	280	1000	1119	1126	1146	1096	1106	1087	1072	1072	WLVEC170028...
1900	280	1000	1246	1254	1273	1224	1234	1214	1200	1200	WLVEC190028...

Triga AW

  Barva je zahrnuta v ceně

DOPORUČUJEME PRO PŘIPOJENÍ ZX:



Integrovaná sada termostatická,

Chrom

 WRZT5G1-CR: 145 EUR

 WRZT5G2-CR: 145 EUR

Stránka: 332



Sada krycí integrovaná, Chrom

TGPCR002: 38 EUR

Stránka: 374



Háček bodový ZIP V 30,
Chrom

WRWZIP012 KCRO: 44 EUR

Stránka: 317



RADIÁTOR VODNÍ:

Připojení:



A ↕ [mm]	B ↔ [mm]	75/65/20°C [W]	55/45/20°C [W]	 [W]	Barvy RAL a speciální barvy Cena bez DPH [EUR]	Kód produktu ... Kód konfigurace s. 385
1700	430	1122	583	1200	1 024	WGVRA170043...
1900	430	1255	652	1200	1 152	WGVRA190043...

Triga AW E



Barva je zahrnuta v ceně

RADIÁTOR ELEKTRICKÝ (CENA VČETNĚ NÁPLNĚ A ZVOLENÉ TOPNÉ TYČE)

Připojení:

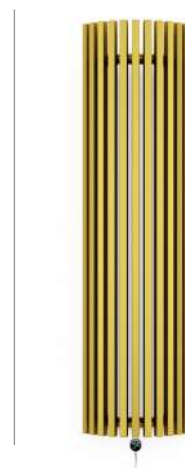

A ↕ [mm]	B ↔ [mm]	Výkon [W]	MEG Cena bez DPH [EUR]	MOA/DRY/ TDY Cena bez DPH [EUR] (MOAIR: +12 EUR) (MOA BLUE: +38 EUR)	ONE Cena bez DPH [EUR] (Nezabudovaná, v 8cm profilu v barvě radiátoru)	REG 2 Cena bez DPH [EUR]	REG 3 Cena bez DPH [EUR]	SIM Cena bez DPH [EUR]	Terma Split třída I Cena bez DPH [EUR] (nezapomeňte si koupit regulátor KTX)	Smart Split třída I Cena bez DPH [EUR] (nezapomeňte si koupit SMART Wi-Fi regulátor VEO)	Kód produktu ... Kód konfigurace s. 388
1700	430	1200	1119	1126	–	1096	1106	1087	–	1072	WLVRA170043...
1900	430	1200	1246	1254	–	1224	1234	1214	–	1199	WLVRA190043...

Triga M



Barva je zahrnuta v ceně

výběr připojení v ceně

DOPORUČUJEME PRO PŘIPOJENÍ SX:



Sada tříosová termostatická s možností montáže topné tyče skrz ventil, Chrom

WRZTCG4-CR: 147 EUR

WRZTCG5-CR: 147 EUR

Stránka: 331



Sada krycí dvojitá, Chrom

TGPCR001: 27 EUR

Stránka: 373



Topná tyč KTX3, Chrom

WEKT3*: 129 EUR

Stránka: 290



RADIÁTOR VODNÍ / VODNĚ-ELEKTRICKÝ (DOKOUPIT TOPNOU TYČ)

Připojení:



A ↕ [mm]	B ↔ [mm]	75/65/20°C [W]	55/45/20°C [W]	[W]	Barvy RAL a speciální barvy Cena bez DPH [EUR]	Kód produktu ... Kód konfigurace s. 385
1700	680	646	332	600	662	WGTRL170068...
1700	780	850	437	800	737	WGTRL170078...
1700	880	1074	552	1000	828	WGTRL170088...
1900	680	721	369	800	708	WGTRL190068...
1900	780	961	492	1000	783	WGTRL190078...
1900	880	1202	615	1200	887	WGTRL190088...

Triga M E



Barva je zahrnuta v ceně



výběr připojení v ceně

RADIÁTOR ELEKTRICKÝ (CENA VČETNĚ NÁPLNĚ A ZVOLENÉ TOPNÉ TYČE)

Připojení:



A ↕ [mm]	B ↔ [mm]	Výkon [W]	MEG Cena bez DPH [EUR]	MOA/DRY/ TDY Cena bez DPH [EUR] (MOAIR: +12 EUR) (MOA BLUE: +38 EUR)	ONE Cena bez DPH [EUR] (Nezabudovaná, v 8cm profilu v barvě radiátoru)	REG 2 Cena bez DPH [EUR]	REG 3 Cena bez DPH [EUR]	SIM Cena bez DPH [EUR]	Terma Split třída I Cena bez DPH [EUR] (nezapomeňte si koupit regulátor KTX)	Smart Split třída I Cena bez DPH [EUR] (nezapomeňte si koupit SMART Wi-Fi regulátor VEO)	Kód produktu ... Kód konfigurace s. 388
1700	680	600	757	764	784	735	745	725	710	710	WLTRL170068...
1700	780	800	832	839	859	810	820	800	785	785	WLTRL170078...
1700	880	1000	922	929	949	900	909	890	875	875	WLTRL170088...
1900	680	800	803	810	830	780	790	771	756	756	WLTRL190068...
1900	780	1000	876	884	903	854	864	844	830	830	WLTRL190078...
1900	880	1200	982	989	–	960	970	950	–	935	WLTRL190088...

Tune HSD



Barva je zahrnuta v ceně



výběr připojení v ceně

DOPORUČUJEME PRO PŘIPOJENÍ YL i YP:



Integrovaná sada termostatická ventil přímý, Chrom

WRZT5G3-CR: 146 EUR

WRZT5G4-CR: 146 EUR

Stránka: 332



Sada krycí integrovaná, Chrom

TGPCR002: 38 EUR

Stránka: 374



RADIÁTOR VODNÍ:

Připojení:



A ↕ [mm]	B ↔ [mm]	75/65/20°C [W]	55/45/20°C [W]	Barvy RAL a speciální barvy Cena bez DPH [EUR]	Kód produktu ... Kód konfigurace s. 385
300	1000	421	229	506	WGTUH030100...
300	1400	589	320	534	WGTUH030140...
390	1000	564	305	562	WGTUH039100...
390	1400	790	428	603	WGTUH039140...

Tune VWD



Barva je zahrnuta v ceně

výběr připojení v ceně

DOPORUČUJEME PRO PŘIPOJENÍ ZX:



Integrovaná sada termostatická,
Chrom

 WRZT5G1-CR: 145 EUR

 WRZT5G2-CR: 145 EUR

Stránka: 332



Sada krycí integrovaná, Chrom

TGPCR002: 38 EUR

Stránka: 374



RADIÁTOR VODNÍ / VODNĚ-ELEKTRICKÝ (DOKOUPIT TOPNOU TYČ)

Připojení:

Výška [mm] 600÷1800:

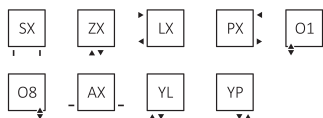

Výška [mm] 600:

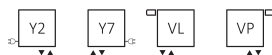

Výška [mm] 1800:

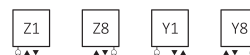

A ↕ [mm]	B ↔ [mm]	75/65/20°C [W]	55/45/20°C [W]	 [W]	Barvy RAL a speciální barvy Cena bez DPH [EUR]	Kód produktu ... Kód konfigurace s. 385
600	590	725	378	800	789	WGTUV060059...
600	790	967	504	1000	971	WGTUV060079...
600	990	1209	630	1200	1 153	WGTUV060099...
600	1190	1450	756	1500	1 336	WGTUV060119...
600	1390	1693	883	1500	1 518	WGTUV060139...
600	1590	1934	1008	–	1 700	WGTUV060159...
1800	190	645	326	600	557	WGTUV180019...
1800	290	967	489	1000	667	WGTUV180029...
1800	390	1289	652	1200	757	WGTUV180039...
1800	490	1612	815	1500	850	WGTUV180049...
1800	590	1934	978	1800	975	WGTUV180059...
1800	690	2257	1141	2000	1 093	WGTUV180069...

Tune VWD E



Barva je zahrnuta v ceně



výběr připojení v ceně

RADIÁTOR ELEKTRICKÝ (CENA VČETNĚ NÁPLNĚ A ZVOLENÉ TOPNÉ TYČE)

Připojení:

Výška [mm] 600:



Výška [mm] 1800:

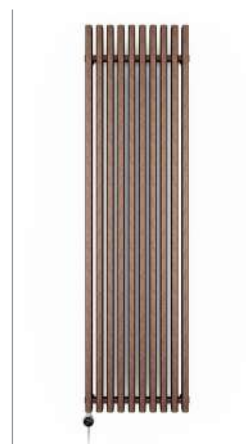

A ↕ [mm]	B ↔ [mm]	Výkon [W]	MEG Cena bez DPH [EUR]	MOA/DRY/ TDY Cena bez DPH [EUR] (MOA IR: +12 EUR) (MOA BLUE: +38 EUR)	ONE Cena bez DPH [EUR] (Nezabudovaná, v 8cm profilu v barvě radiátoru)	REG 2 Cena bez DPH [EUR]	REG 3 Cena bez DPH [EUR]	SIM Cena bez DPH [EUR]	Terma Split třída I Cena bez DPH [EUR] (nezapomeňte si koupit regulátor KTX)	Smart Split třída I Cena bez DPH [EUR] (nezapomeňte si koupit SMART Wi-Fi regulátor VEO)	Kód produktu ... Kód konfigurace s. 388
600	590	800	884	891	911	862	871	852	837	837	WLTUV060059...
600	790	1000	1066	1073	1093	1044	1053	1034	1019	1019	WLTUV060079...
600	990	1200	1248	1255	–	1225	1235	1216	–	1201	WLTUV060099...
600	1190	1500	–	–	–	–	–	1399	–	1384	WLTUV060119...
600	1390	1500	–	–	–	–	–	1581	–	1566	WLTUV060139...
600	1590	1500	–	–	–	–	–	1763	–	1748	WLTUV060159...
1800	190	800	652	659	679	630	640	620	605	605	WLTUV180019...
1800	290	1000	762	769	789	740	750	730	715	715	WLTUV180029...
1800	390	1200	852	859	–	830	840	820	–	805	WLTUV180039...
1800	490	1500	–	–	–	–	–	912	–	897	WLTUV180049...
1800	590	1800	–	–	–	–	–	–	–	1023	WLTUV180059...
1800	690	2000	–	–	–	–	–	–	–	1140	WLTUV180069...

Tune VWS



Barva je zahrnuta v ceně

výběr připojení v ceně

DOPORUČUJEME PRO PŘIPOJENÍ ZX:



Integrovaná sada termostatická,

Chrom

WRZT5G1-CR: 145 EUR

WRZT5G2-CR: 145 EUR

Stránka: 332

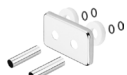

Sada krycí integrovaná, Chrom

TGPCR002: 38 EUR

Stránka: 374



RADIÁTOR VODNÍ / VODNĚ-ELEKTRICKÝ (DOKOUPIT TOPNOU TYČ)

Připojení:

Výška [mm] 600÷1800:

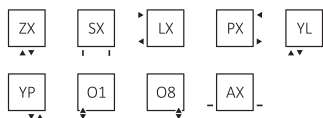

Výška [mm] 600:

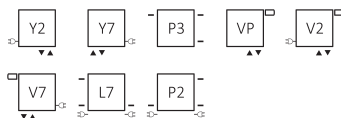

Výška [mm] 1800:

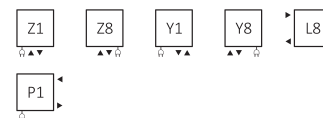

A ↕ [mm]	B ↔ [mm]	75/65/20°C [W]	55/45/20°C [W]	 [W]	Barvy RAL a speciální barvy Cena bez DPH [EUR]	Kód produktu ... Kód konfigurace s. 385
600	590	450	240	400	514	WGTSV060059...
600	790	602	321	600	593	WGTSV060079...
600	990	752	401	800	675	WGTSV060099...
600	1190	902	481	1000	772	WGTSV060119...
600	1390	1053	561	1000	852	WGTSV060139...
600	1590	1203	641	1200	933	WGTSV060159...
1800	290	608	305	600	496	WGTSV180029...
1800	390	800	427	800	591	WGTSV180039...
1800	490	1014	509	1000	675	WGTSV180049...
1800	590	1200	641	1200	739	WGTSV180059...
1800	690	1420	713	1500	804	WGTSV180069...
1800	790	1700	854	1800	886	WGTSV180079...

Tune VWS E



Barva je zahrnuta v ceně



výběr připojení v ceně

RADIÁTOR ELEKTRICKÝ (CENA VČETNĚ NÁPLNĚ A ZVOLENÉ TOPNÉ TYČE)

Připojení:

Výška [mm] 600:



Výška [mm] 1800:

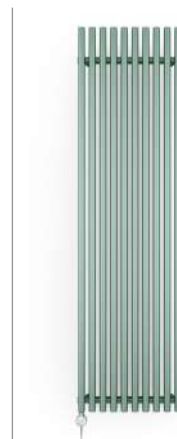

A ↕ [mm]	B ↔ [mm]	Výkon [W]	MEG Cena bez DPH [EUR]	MOA/DRY/ TDY Cena bez DPH [EUR] (MOAIR: +12 EUR) (MOA BLUE: +38 EUR)	ONE Cena bez DPH [EUR] (Nezabudovaná, v 8cm profilu v barvě radiátoru)	REG 2 Cena bez DPH [EUR]	REG 3 Cena bez DPH [EUR]	SIM Cena bez DPH [EUR]	Terma Split třída I Cena bez DPH [EUR] (nezapomeňte si koupit regulátor KTX)	Smart Split třída I Cena bez DPH [EUR] (nezapomeňte si koupit SMART Wi-Fi regulátor VEO)	Kód produktu ... Kód konfigurace s. 388
600	590	400	608	616	635	586	596	576	562	562	WLTSV060059...
600	790	600	688	696	715	666	676	656	641	641	WLTSV060079...
600	990	800	769	777	796	747	757	737	723	723	WLTSV060099...
600	1190	1000	866	874	894	844	854	834	820	820	WLTSV060119...
600	1390	1000	946	954	973	924	934	914	900	900	WLTSV060139...
600	1590	1200	1028	1035	–	1005	1015	996	–	981	WLTSV060159...
1800	290	600	591	598	618	569	579	559	544	544	WLTSV180029...
1800	390	800	686	693	713	664	674	654	639	639	WLTSV180039...
1800	490	1000	769	777	796	747	757	737	723	723	WLTSV180049...
1800	590	1200	834	841	861	812	822	802	–	787	WLTSV180059...
1800	690	1500	–	–	–	–	–	866	–	852	WLTSV180069...
1800	790	1800	–	–	–	–	–	–	–	934	WLTSV180079...



Barva je zahrnutá v ceně

výběr připojení v ceně

DOPORUČUJEME PRO PŘIPOJENÍ ZX, Z1 i Z8:



Integrovaná sada termostatická, Chrom

 WRZT5G1-CR: 145 EUR

 WRZT5G2-CR: 145 EUR

Stránka: 332



Sada krycí integrovaná, Chrom

TGPCR002: 38 EUR

Stránka: 374



Háček bodový YO!

WRWYOY001*: 4 EUR

Stránka: 316



Topná tyč KTX4 BLUE, Chrom

WEK4B*: 161 EUR

Stránka: 288



RADIÁTOR VODNÍ / VODNĚ-ELEKTRICKÝ (DOKOUPIT TOPNOU TYČ)

Připojení:



A ↕ [mm]	B ↔ [mm]	75/65/20°C [W]	55/45/20°C [W]	 [W]	Barvy RAL a speciální barvy Cena bez DPH [EUR]	Kód produktu ... Kód konfigurace s. 385
820	440	533	288	600	295	WGTYT082044...
820	540	645	348	600	317	WGTYT082054...
820	640	755	407	800	333	WGTYT082064...
1020	440	666	358	600	339	WGTYT102044...
1020	540	806	433	800	361	WGTYT102054...
1020	640	943	507	1000	387	WGTYT102064...
1260	440	828	444	800	387	WGTYT126044...
1260	540	1002	537	1000	415	WGTYT126054...
1260	640	1173	628	1200	447	WGTYT126064...
1420	440	930	497	1000	415	WGTYT142044...
1420	540	1126	602	1200	442	WGTYT142054...
1420	640	1317	704	1200	480	WGTYT142064...
1780	440	1167	623	1200	474	WGTYT178044...
1780	540	1412	753	1500	512	WGTYT178054...
1780	640	1652	881	1500	550	WGTYT178064...

Tytus E



Barva je zahrnuta v ceně



výběr připojení v ceně

RADIÁTOR ELEKTRICKÝ (CENA VČETNĚ NÁPLNĚ A ZVOLENÉ TOPNÉ TYČE)





E1





E8







A ↕ [mm]	B ↔ [mm]	Výkon [W]	MEG Cena bez DPH [EUR]	MOA/DRY/TDY Cena bez DPH [EUR] (MOA IR: +12 EUR) (MOA BLUE: +38 EUR)	ONE Cena bez DPH [EUR] (Nezabudovaná, v 8cm profilu v barvě radiátoru)	REG 2 Cena bez DPH [EUR]	REG 3 Cena bez DPH [EUR]	SIM Cena bez DPH [EUR]	Terma Split třída I Cena bez DPH [EUR] (nezapomeňte si koupit regulátor KTX)	Smart Split třída I Cena bez DPH [EUR] (nezapomeňte si koupit SMART Wi-Fi regulátor VEO)	Kód produktu ... Kód konfigurace s. 388
820	440	600	389	397	416	367	377	357	343	343	WLTYT082044...
820	540	600	412	419	439	389	399	380	365	365	WLTYT082054...
820	640	800	427	435	455	405	415	396	381	381	WLTYT082064...
1020	440	600	434	441	461	412	421	402	387	387	WLTYT102044...
1020	540	800	455	462	482	432	442	423	408	408	WLTYT102054...
1020	640	1000	482	489	509	459	469	450	435	435	WLTYT102064...
1260	440	800	482	489	509	459	469	450	435	435	WLTYT126044...
1260	540	1000	510	517	537	488	498	478	463	463	WLTYT126054...
1260	640	1200	542	549	–	520	530	510	–	495	WLTYT126064...
1420	440	1000	510	517	537	488	498	478	463	463	WLTYT142044...
1420	540	1200	537	544	–	515	525	505	–	490	WLTYT142054...
1420	640	1200	575	582	–	553	563	543	–	528	WLTYT142064...
1780	440	1200	569	576	–	547	557	537	–	522	WLTYT178044...
1780	540	1500	–	–	–	–	–	575	–	560	WLTYT178054...
1780	640	1500	–	–	–	–	–	613	–	598	WLTYT178064...

Tytus One



 Barva je zahrnuta v ceně
 
 výběr připojení v ceně

 45-60°C/2
  P-W-U
  120-1000W
  IR

 TŘÍDA I
  IPx5
  2h/1
 

SADA OBSAHUJE:

Radiátor se zabudovanou topnou tyčí One. Funkce topné tyče ONE: Stránka 287.

DOPORUČUJEME PRO PŘIPOJENÍ S1 i S8:



Integrovaná sada termostatická s ponornou trubicí, Chrom

 WRZT5G5-CR: 151EUR

 WRZT5G6-CR: 151EUR

Stránka: 334



Sada krycí integrovaná, Chrom

TGPCR002: 38EUR

Stránka: 374



Háček bodový YO!

WRWYOY001*: 4EUR

Stránka: 316



Regulátor TTIR1

TGRTBI001: 104EUR

Stránka: 304



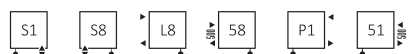

RADIÁTOR VODNĚ-ELEKTRICKÝ (CENA VČETNĚ ZABUDOVANÉ TOPNÉ TYČE ONE)

Připojení:

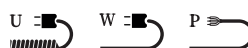

Vyber druh kabelu:



A ↕ [mm]	B ↔ [mm]	75/65/20°C [W]	55/45/20°C [W]	 [W]	Barvy RAL a speciální barvy Cena bez DPH [EUR]	Kód produktu ... Kód konfigurace s. 386
820	440	533	288	600	392	WZTYN082044...
820	540	645	348	600	414	WZTYN082054...
820	640	755	407	800	430	WZTYN082064...
1020	440	666	358	600	436	WZTYN102044...
1020	540	806	433	800	457	WZTYN102054...
1020	640	943	507	1000	484	WZTYN102064...
1260	440	828	444	800	484	WZTYN126044...
1260	540	1002	537	1000	512	WZTYN126054...
1420	440	930	497	1000	512	WZTYN142044...

Tytus One E



Barva je zahrnuta v ceně



výběr připojení v ceně



TŘÍDA I



45-60°C/2



P-W-U



120-1000W



IR



IPx5



2h/1



RADIÁTOR ELEKTRICKÝ (CENA VČETNĚ NÁPLNĚ A ZABUDOVANÉ TOPNÉ TYČE ONE)

Připojení:



A ↕ [mm]	B ↔ [mm]	Výkon [W]	Barvy RAL a speciální barvy Cena bez DPH [EUR]	Kód produktu ... Kód konfigurace s. 387
820	440	600	410	WWTYN082044...
820	540	600	432	WWTYN082054...
820	640	800	448	WWTYN082064...
1020	440	600	455	WWTYN102044...
1020	540	800	475	WWTYN102054...
1020	640	1000	502	WWTYN102064...
1260	440	800	502	WWTYN126044...
1260	540	1000	531	WWTYN126054...
1420	440	1000	531	WWTYN142044...

Vipera



Barva je zahrnuta v ceně

výběr připojení v ceně

DOPORUČUJEME PRO PŘIPOJENÍ ZX, Z1 i Z8:



Integrovaná sada termostatická, Chrom

 WRZT5G1-CR: 145 EUR

 WRZT5G2-CR: 145 EUR

Stránka: 332



Sada krycí integrovaná, Chrom

TGPCR002: 38 EUR

Stránka: 374



Topná tyč MOA BLUE, Chrom

WEMOB01*: 142 EUR

Stránka: 293



RADIÁTOR VODNÍ / VODNĚ-ELEKTRICKÝ (DOKOUPIT TOPNOU TYČ)

Připojení:

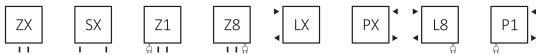

Výška [mm] 750 ÷ 1710:



A ↑ [mm]	B ↔ [mm]	75/65/20°C [W]	55/45/20°C [W]	 [W]	Barvy RAL a speciální barvy Cena bez DPH [EUR]	Kód produktu ... Kód konfigurace s. 385
510	400	165	90	200	211	WGVPA051040...
510	500	194	106	200	225	WGVPA051050...
510	600	223	122	200	232	WGVPA051060...
750	400	240	130	200	239	WGVPA075040...
750	500	263	143	300	257	WGVPA075050...
750	600	326	177	300	266	WGVPA075060...
990	400	315	170	300	269	WGVPA099040...
990	500	372	201	400	290	WGVPA099050...
990	600	428	231	400	302	WGVPA099060...
1230	400	386	208	400	298	WGVPA123040...
1230	500	456	245	400	323	WGVPA123050...
1230	600	525	283	600	336	WGVPA123060...
1470	400	462	248	400	329	WGVPA147040...
1470	500	546	293	600	356	WGVPA147050...
1470	600	629	337	600	372	WGVPA147060...
1710	400	537	287	600	359	WGVPA171040...
1710	500	634	339	600	389	WGVPA171050...
1710	600	730	391	800	408	WGVPA171060...

Vipera E



Barva je zahrnuta v ceně



výběr připojení v ceně



RADIÁTOR ELEKTRICKÝ (CENA VČETNĚ NÁPLNĚ A ZVOLENÉ TOPNÉ TYČE)

Připojení:



A ↕ [mm]	B ↔ [mm]	Výkon [W]	MEG Cena bez DPH [EUR]	MOA/DRY/ TDY Cena bez DPH [EUR] (MOAIR: +12 EUR) (MOABLU: +38 EUR)	ONE Cena bez DPH [EUR] (Nezabudovaná, v 8cm profilu v barvě radiátoru)	REG 2 Cena bez DPH [EUR]	REG 3 Cena bez DPH [EUR]	SIM Cena bez DPH [EUR]	Terma Split třída I Cena bez DPH [EUR] (nezapomeňte si koupit regulátor KTX)	Smart Split třída I Cena bez DPH [EUR] (nezapomeňte si koupit SMART Wi-Fi regulátor VEO)	Kód produktu ... Kód konfigurace s.388
510	400	200	306	313	333	284	293	274	259	259	WLVPA051040...
510	500	200	319	327	346	297	307	287	273	273	WLVPA051050...
510	600	200	327	334	354	305	314	295	280	280	WLVPA051060...
750	400	200	334	341	361	312	322	302	287	287	WLVPA075040...
750	500	300	351	359	378	329	339	319	305	305	WLVPA075050...
750	600	300	361	368	388	339	349	329	314	314	WLVPA075060...
990	400	300	364	371	391	341	351	332	317	317	WLVPA099040...
990	500	400	384	392	412	362	372	352	338	338	WLVPA099050...
990	600	400	397	404	424	375	384	365	350	350	WLVPA099060...
1230	400	400	393	400	420	371	381	361	346	346	WLVPA123040...
1230	500	400	418	425	445	396	405	386	371	371	WLVPA123050...
1230	600	600	431	439	458	409	419	399	384	384	WLVPA123060...
1470	400	400	424	431	451	402	412	392	377	377	WLVPA147040...
1470	500	600	451	458	478	429	439	419	404	404	WLVPA147050...
1470	600	600	467	474	494	445	455	435	420	420	WLVPA147060...
1710	400	600	453	461	480	431	441	421	407	407	WLVPA171040...
1710	500	600	484	491	511	462	472	452	437	437	WLVPA171050...
1710	600	800	502	510	530	480	490	471	456	456	WLVPA171060...

Vipera One



 Barva je zahrnuta v ceně

 výběr připojení v ceně



DOPORUČUJEME PRO PŘIPOJENÍ S1 i S8:



Integrovaná sada termostatická s ponornou trubicí, Chrom

 WRZT5G5-CR: 151EUR

 WRZT5G6-CR: 151EUR

Stránka: 334

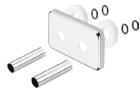

Sada krycí integrovaná, Chrom

TGPCR002: 38EUR

Stránka: 374



Regulátor TTIR1

TGRTBI001: 104EUR

Stránka: 304



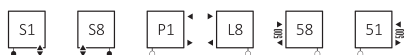

RADIÁTOR VODNĚ-ELEKTRICKÝ (CENA VČETNĚ ZABUDOVANÉ TOPNÉ TYČE ONE)

Připojení:

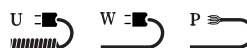

Vyber druh kabelu:



A ↕ [mm]	B ↔ [mm]	75/65/20°C [W]	55/45/20°C [W]	 [W]	Barvy RAL a speciální barvy Cena bez DPH [EUR]	Kód produktu ... Kód konfigurace s. 386
750	400	240	130	200	336	WZVPN075040...
750	500	263	143	300	354	WZVPN075050...
750	600	326	177	300	364	WZVPN075060...
990	400	315	170	300	366	WZVPN099040...
990	500	372	201	400	387	WZVPN099050...
990	600	428	231	400	399	WZVPN099060...
1230	400	386	208	400	396	WZVPN123040...
1230	500	456	245	400	420	WZVPN123050...
1230	600	525	283	600	434	WZVPN123060...
1470	400	462	248	400	426	WZVPN147040...
1470	500	546	293	600	453	WZVPN147050...
1470	600	629	337	600	469	WZVPN147060...
1710	400	537	287	600	456	WZVPN171040...
1710	500	634	339	600	487	WZVPN171050...
1710	600	730	391	800	505	WZVPN171060...

Vipera One E



Barva je zahrnuta v ceně



výběr připojení v ceně



TŘÍDA I



45-60°C/2



P-W-U



120-1000W



IR



IPx5



2h/1



RADIÁTOR ELEKTRICKÝ (CENA VČETNĚ NÁPLNĚ A ZABUDOVANÉ TOPNÉ TYČE ONE)

Připojení:



A ↕ [mm]	B ↔ [mm]	Výkon [W]	Barvy RAL a speciální barvy Cena bez DPH [EUR]	Kód produktu ... Kód konfigurace s.387
750	400	200	355	WWVPN075040...
750	500	300	372	WWVPN075050...
750	600	300	382	WWVPN075060...
990	400	300	384	WWVPN099040...
990	500	400	405	WWVPN099050...
990	600	400	418	WWVPN099060...
1230	400	400	414	WWVPN123040...
1230	500	400	439	WWVPN123050...
1230	600	600	452	WWVPN123060...
1470	400	400	445	WWVPN147040...
1470	500	600	472	WWVPN147050...
1470	600	600	488	WWVPN147060...
1710	400	600	474	WWVPN171040...
1710	500	600	505	WWVPN171050...
1710	600	800	523	WWVPN171060...



Barva je zahrnuta v ceně

výběr připojení v ceně

DOPORUČUJEME PRO PŘIPOJENÍ SX:



Sada tříosová termostatická s možností montáže topné tyče skrz ventil, Chrom

WRZTCG4-CR: 147 EUR

WRZTCG5-CR: 147 EUR

Stránka: 331



Sada krycí dvojitá, Chrom

TGPCR001: 27 EUR

Stránka: 373



Háček HAPPY SHARK

300 mm - WRWH1A024: 21 EUR

400 mm - WRWH1A034: 21 EUR

500 mm - WRWH1A044: 21 EUR

600 mm - WRWH1A054: 21 EUR

Stránka: 319



Háček HAPPY RABBIT

300 mm - WRWH1B024: 21 EUR

400 mm - WRWH1B034: 21 EUR

500 mm - WRWH1B044: 21 EUR

600 mm - WRWH1B054: 21 EUR

Stránka: 319



RADIÁTOR VODNÍ / VODNĚ-ELEKTRICKÝ (DOKOUPIT TOPNOU TYČ)

Připojení:

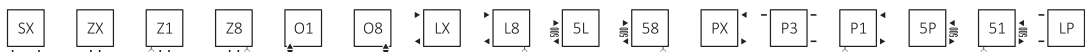

A ↕ [mm]	B ↔ [mm]	Barva ze vzorníku RAL a speciálních barev			Galvanický povrch Chrom			Barvy RAL a speciální barvy Cena bez DPH [EUR]	Chrom Cena bez DPH [EUR]	Kód produktu ... Kód konfigurace s. 385
		75/65/20°C [W]	55/45/20°C [W]	 [W]	75/65/20°C [W]	55/45/20°C [W]	 [W]			
670	300	185	100	200	130	70	120	168	270	WGVOV067030...
670	400	230	124	200	161	87	200	178	306	WGVOV067040...
670	500	275	148	300	193	104	200	190	343	WGVOV067050...
670	600	320	172	300	224	120	200	205	380	WGVOV067060...
910	300	240	130	200	168	91	200	185	330	WGVOV091030...
910	400	295	159	300	207	111	200	198	377	WGVOV091040...
910	500	350	189	400	245	132	300	211	424	WGVOV091050...
910	600	405	218	400	284	153	300	231	475	WGVOV091060...
1150	300	300	162	300	210	113	200	204	391	WGVOV115030...
1150	400	366	197	400	256	138	300	218	447	WGVOV115040...
1150	500	433	233	400	303	163	300	234	509	WGVOV115050...
1150	600	501	269	600	351	188	400	257	566	WGVOV115060...
1390	300	356	192	400	249	134	300	222	451	WGVOV139030...
1390	400	434	234	400	304	164	300	237	517	WGVOV139040...
1390	500	512	275	600	358	193	400	257	590	WGVOV139050...
1390	600	590	316	600	413	221	400	282	661	WGVOV139060...
1630	300	414	223	400	290	156	300	239	506	WGVOV163030...
1630	400	503	270	600	352	189	400	258	593	WGVOV163040...
1630	500	592	318	600	414	223	400	279	675	WGVOV163050...
1630	600	681	365	800	477	256	400	309	757	WGVOV163060...

Vivo E



Barva je zahrnuta v ceně



výběr připojení v ceně

RADIÁTOR ELEKTRICKÝ (CENA VČETNĚ NÁPLNĚ A ZVOLENÉ TOPNÉ TYČE)

Připojení:



A ↕ [mm]	B ↔ [mm]	Výkon [W]		MEG		MOA/DRY/TDY		ONE		REG 2		REG 3		SIM		Terma Split třída I		Smart Split třída I		Kód produktu ... Kód konfigurace s. 388
				Cena bez DPH [EUR]		Cena bez DPH [EUR] (MOA IR: +12 EUR) (MOA BLUE: +38 EUR)		Cena bez DPH [EUR] (Nezabudovaná, v 8cm profilu v barvě radiátoru)		Cena bez DPH [EUR]		Cena bez DPH [EUR]		Cena bez DPH [EUR]		Cena bez DPH [EUR] (nezapomenejte si koupit regulátor KTX)		Cena bez DPH [EUR] (nezapomenejte si koupit SMART Wi-Fi regulátor VEO)		
		Barva	Chrom	Barvy RAL a speciální barvy	Chrom	Barvy RAL a speciální barvy	Chrom	Barvy RAL a speciální barvy	Chrom	Barvy RAL a speciální barvy	Chrom	Barvy RAL a speciální barvy	Chrom	Barvy RAL a speciální barvy	Chrom	Barvy RAL a speciální barvy	Chrom	Barvy RAL a speciální barvy	Chrom	
670	300	200	120	263	365	270	372	290	392	241	343	250	352	231	333	216	318	216	318	WLVOV067030...
670	400	200	200	273	400	280	408	300	427	250	378	260	388	241	368	226	354	226	354	WLVOV067040...
670	500	300	200	285	437	292	445	312	464	263	415	273	425	253	405	238	391	238	391	WLVOV067050...
670	600	300	200	300	474	307	482	327	501	277	452	287	462	268	442	253	427	253	427	WLVOV067060...
910	300	200	200	280	425	287	432	307	452	258	403	268	413	248	393	233	378	233	378	WLVOV091030...
910	400	300	200	292	472	300	479	319	499	270	450	280	459	260	440	246	425	246	425	WLVOV091040...
910	500	400	300	306	518	313	526	333	546	284	496	293	506	274	487	259	472	259	472	WLVOV091050...
910	600	400	300	325	570	333	577	352	597	303	548	313	558	293	538	279	523	279	523	WLVOV091060...
1150	300	300	200	298	485	306	493	325	512	276	463	286	473	266	453	252	439	252	439	WLVOV115030...
1150	400	400	300	312	542	319	549	339	569	290	520	300	530	280	510	265	495	265	495	WLVOV115040...
1150	500	400	300	329	603	336	611	356	630	307	581	317	591	297	571	282	557	282	557	WLVOV115050...
1150	600	600	400	351	660	359	667	378	687	329	638	339	648	319	628	305	613	305	613	WLVOV115060...
1390	300	400	300	316	546	323	553	343	573	293	523	303	533	284	514	269	499	269	499	WLVOV139030...
1390	400	400	300	332	612	339	619	359	639	309	590	319	600	300	580	285	565	285	565	WLVOV139040...
1390	500	600	400	351	684	359	692	378	712	329	662	339	672	319	653	305	638	305	638	WLVOV139050...
1390	600	600	400	377	756	384	763	404	783	355	734	365	743	345	724	330	709	330	709	WLVOV139060...
1630	300	400	300	334	601	341	608	361	628	312	579	322	589	302	569	287	554	287	554	WLVOV163030...
1630	400	600	400	352	688	360	696	380	715	330	666	340	676	321	656	306	641	306	641	WLVOV163040...
1630	500	600	400	373	769	381	777	400	796	351	747	361	757	341	737	327	723	327	723	WLVOV163050...
1630	600	800	400	403	852	410	859	430	879	381	830	391	839	371	820	356	805	356	805	WLVOV163060...

Vivo One



Barva je zahrnuta v ceně



výběr připojení v ceně



TŘÍDA I



45-60°C/2



P-W-U

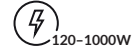

120-1000W



IR



IPx5



2h/1



IR



IR

DOPORUČUJEME PRO PŘIPOJENÍ S1 i S8:



Integrovaná sada termos-
tatická s ponornou trubicí,
Chrom



WRZT5G5-CR: 151 EUR



WRZT5G6-CR: 151 EUR

Stránka: 334

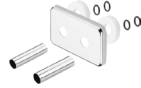

Sada krycí integrovaná,
Chrom

TGPCR002: 38 EUR

Stránka: 374



Háček HAPPY SHARK

300 mm - WRWH1A024: 21 EUR

400 mm - WRWH1A034: 21 EUR

500 mm - WRWH1A044: 21 EUR

600 mm - WRWH1A054: 21 EUR

Stránka: 319



Háček HAPPY RABBIT

300 mm - WRWH1B024: 21 EUR

400 mm - WRWH1B034: 21 EUR

500 mm - WRWH1B044: 21 EUR

600 mm - WRWH1B054: 21 EUR

Stránka: 319



RADIÁTOR VODNĚ-ELEKTRICKÝ (CENA VČETNĚ ZABUDOVANÉ TOPNÉ TYČE ONE)

Připojení:



Vyber druh kabelu:



A ↓ [mm]	B ↔ [mm]	Barva ze vzorníku RAL a speciálních barev			Galvanický povrch Chrom			Barvy RAL a speciální barvy <small>Cena bez DPH [EUR]</small>	Chrom <small>Cena bez DPH [EUR]</small>	Kód produktu <small>... Kód konfigurace s. 386</small>
		75/65/20°C [W]	55/45/20°C [W]	[W]	75/65/20°C [W]	55/45/20°C [W]	[W]			
670	300	185	100	200	130	70	120	265	367	WZVON067030...
670	400	230	124	200	161	87	200	275	403	WZVON067040...
670	500	275	148	300	193	104	200	287	440	WZVON067050...
670	600	320	172	300	224	120	200	302	477	WZVON067060...
910	300	240	130	200	168	91	200	282	427	WZVON091030...
910	400	295	159	300	207	111	200	295	474	WZVON091040...
910	500	350	189	400	245	132	300	308	521	WZVON091050...
910	600	405	218	400	284	153	300	328	573	WZVON091060...
1150	300	300	162	300	210	113	200	301	488	WZVON115030...
1150	400	366	197	400	256	138	300	314	544	WZVON115040...
1150	500	433	233	400	303	163	300	332	606	WZVON115050...
1150	600	501	269	600	351	188	400	354	662	WZVON115060...
1390	300	356	192	400	249	134	300	318	548	WZVON139030...
1390	400	434	234	400	304	164	300	334	614	WZVON139040...
1390	500	512	275	600	358	193	400	354	687	WZVON139050...
1390	600	590	316	600	413	221	400	380	758	WZVON139060...
1630	300	414	223	400	290	156	300	336	603	WZVON163030...
1630	400	503	270	600	352	189	400	355	691	WZVON163040...
1630	500	592	318	600	414	223	400	376	772	WZVON163050...
1630	600	681	365	800	477	256	400	405	854	WZVON163060...

Vivo One E



Barva je zahrnuta v ceně



výběr připojení v ceně



TŘÍDA I



45-60°C/2



P-W-U



120-1000W



IR



IPx5



2h/1



SSS



SNOW

RADIÁTOR ELEKTRICKÝ (CENA VČETNĚ NÁPLNĚ A ZABUDOVANÉ TOPNÉ TYČE ONE)

Připojení:



A ↕ [mm]	B ↔ [mm]	Výkon [W]		Barvy RAL a speciální barvy Cena bez DPH [EUR]	Chrom Cena bez DPH [EUR]	Kód produktu ... Kód konfigurace s. 387
		Barva	Chrom			
670	300	200	120	284	386	WWWON067030...
670	400	200	200	293	421	WWWON067040...
670	500	300	200	306	458	WWWON067050...
670	600	300	200	321	495	WWWON067060...
910	300	200	200	301	446	WWWON091030...
910	400	300	200	313	493	WWWON091040...
910	500	400	300	327	539	WWWON091050...
910	600	400	300	346	591	WWWON091060...
1150	300	300	200	319	506	WWWON115030...
1150	400	400	300	333	563	WWWON115040...
1150	500	400	300	350	624	WWWON115050...
1150	600	600	400	372	681	WWWON115060...
1390	300	400	300	336	566	WWWON139030...
1390	400	400	300	352	633	WWWON139040...
1390	500	600	400	372	705	WWWON139050...
1390	600	600	400	398	777	WWWON139060...
1630	300	400	300	355	622	WWWON163030...
1630	400	600	400	373	709	WWWON163040...
1630	500	600	400	394	790	WWWON163050...
1630	600	800	400	424	873	WWWON163060...

Warp Room



Barva je zahrnuta v ceně

výběr připojení v ceně

DOPORUČUJEME PRO PŘIPOJENÍ ZX, YL, YP, Y2, Y7:



Integrovaná sada termostatická, Chrom

WRZT5G1-CR: 145 EUR

WRZT5G2-CR: 145 EUR

Stránka: 276



Sada krycí integrovaná, Chrom

TGPCR002: 38 EUR

Stránka: 318



RADIÁTOR VODNÍ / VODNĚ-ELEKTRICKÝ (DOKOUPIT TOPNOU TYČ)

Připojení:

Výška [mm] 330÷630:

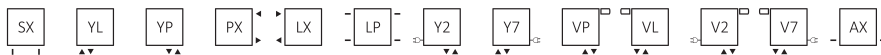

Výška [mm] 1200÷1800:



A ⇕ [mm]	B ⇔ [mm]	Barva ze vzorníku RAL a speciálních barev			Barvy RAL a speciální barvy Cena bez DPH [EUR]	Kód produktu ... Kód konfigurace s. 385
		75/65/20°C [W]	55/45/20°C [W]	[W]		
330	525	324	167	300	297	WGWAR033052...
330	785	486	251	600	382	WGWAR033078...
330	1045	648	334	600	467	WGWAR033104...
330	1305	810	418	800	552	WGWAR033130...
330	1565	972	502	1000	637	WGWAR033156...
330	1825	1134	585	1200	722	WGWAR033182...
530	525	495	258	600	342	WGWAR053052...
530	785	743	388	800	449	WGWAR053078...
530	1045	990	516	1000	556	WGWAR053104...
530	1305	1238	646	1200	663	WGWAR053130...
530	1565	1486	775	1500	770	WGWAR053156...
530	1825	1733	904	1500	866	WGWAR053182...
630	525	578	303	600	363	WGWAR063052...
630	785	868	455	800	480	WGWAR063078...
630	1045	1157	607	1200	597	WGWAR063104...
630	1305	1446	758	1500	714	WGWAR063130...
630	1565	1735	910	1500	831	WGWAR063156...
630	1825	2024	1061	2000	948	WGWAR063182...
1200	395	779	410	-	473	WGWAR120039...
1200	525	1038	546	-	593	WGWAR120052...
1200	655	1298	683	-	713	WGWAR120065...
1600	395	1016	527	-	536	WGWAR160039...
1600	525	1355	703	-	666	WGWAR160052...
1600	655	1694	879	-	816	WGWAR160065...
1800	395	1135	585	-	568	WGWAR180039...
1800	525	1514	780	-	718	WGWAR180052...
1800	655	1892	975	-	880	WGWAR180065...

Warp Room E



Barva je zahrnuta v ceně



výběr připojení v ceně

RADIÁTOR ELEKTRICKÝ

(CENA VČETNĚ NÁPLNĚ A ZVOLENÉ TOPNÉ TYČE)

Připojení:



A ↕ [mm]	B ↔ [mm]	Výkon [W]	MEG Cena bez DPH [EUR]	MOA/DRY/ TDY Cena bez DPH [EUR] (MOA IR: +12 EUR) (MOA BLUE: +38 EUR)	ONE Cena bez DPH [EUR] (Nezabudovaná, v 8cm profilu v barvě radiátoru)	REG 2 Cena bez DPH [EUR]	REG 3 Cena bez DPH [EUR]	SIM Cena bez DPH [EUR]	Terma Split třída I Cena bez DPH [EUR] (nezapomeňte si koupit regulátor KTX)	Smart Split třída I Cena bez DPH [EUR] (nezapomeňte si koupit SMARTWi-Fi regulátor VEO)	Kód produktu ... Kód konfigurace s. 388
330	525	300	392	399	419	370	380	360	345	345	WLWAR033052...
330	785	600	477	484	504	455	465	445	430	430	WLWAR033078...
330	1045	600	562	569	589	540	550	530	515	515	WLWAR033104...
330	1305	800	647	654	674	625	635	615	600	600	WLWAR033130...
330	1565	1000	732	739	759	710	720	700	685	685	WLWAR033156...
330	1825	1200	817	824	–	795	805	785	–	770	WLWAR033182...
530	525	600	437	444	464	415	425	405	390	390	WLWAR053052...
530	785	800	544	551	571	522	532	512	497	497	WLWAR053078...
530	1045	1000	651	658	678	629	639	619	604	604	WLWAR053104...
530	1305	1200	758	765	–	736	746	726	–	711	WLWAR053130...
530	1565	1500	–	–	–	–	–	833	–	818	WLWAR053156...
530	1825	1500	–	–	–	–	–	–	–	914	WLWAR053182...
630	525	600	458	465	485	436	446	426	411	411	WLWAR063052...
630	785	800	575	582	602	553	563	543	528	528	WLWAR063078...
630	1045	1200	692	699	–	670	680	660	–	645	WLWAR063104...
630	1305	1500	–	–	–	–	–	777	–	762	WLWAR063130...
630	1565	1500	–	–	–	–	–	894	–	879	WLWAR063156...
630	1825	2000	–	–	–	–	–	–	–	996	WLWAR063182...

Warp S



Barva je zahrnuta v ceně



výběr připojení v ceně

DOPORUČUJEME PRO PŘIPOJENÍ GD:



Sada komplexní integrovaný ventil s T- kusem s možností připojení topné tyče skrze ventil, Chrom

 WRZT5G14-CR: 188EUR

 WRZT5G15-CR: 188EUR

Stránka: 333



Sada krycí integrovaná, Chrom

TGPCR002: 38EUR

Stránka: 374



Topná tyč MOA, Chrom

WEMOA*: 105EUR

Stránka: 295



RADIÁTOR VODNÍ / VODNĚ-ELEKTRICKÝ (DOKOUPIT TOPNOU TYČ)

Připojení:



A ↕ [mm]	B ↔ [mm]	75/65/20°C [W]	55/45/20°C [W]	 [W]	Barvy RAL a speciální barvy Cena bez DPH [EUR]	Kód produktu ... Kód konfigurace s. 385
655	500	450	241	–	281	WGWAS065050...
655	600	506	271	–	309	WGWAS065060...
785	500	551	297	600	341	WGWAS078050...
785	600	653	351	600	373	WGWAS078060...
915	500	643	346	600	379	WGWAS091050...
915	600	761	408	800	409	WGWAS091060...
1110	500	764	406	800	400	WGWAS111050...
1110	600	857	456	800	442	WGWAS111060...
1695	500	1167	620	1200	560	WGWAS169050...
1695	600	1310	696	1200	627	WGWAS169060...

Warp S E



Barva je zahrnuta v ceně



výběr připojení v ceně

RADIÁTOR ELEKTRICKÝ (CENA VČETNĚ NÁPLNĚ A ZVOLENÉ TOPNÉ TYČE)

Připojení:



A ↕ [mm]	B ↔ [mm]	Výkon [W]	MEG Cena bez DPH [EUR]	MOA/DRY/ TDY Cena bez DPH [EUR] (MOA IR: +12 EUR) (MOA BLUE: +38 EUR)	ONE Cena bez DPH [EUR] (Nezabudovaná, v 8cm profilu v barvě radiátoru)	REG 2 Cena bez DPH [EUR]	REG 3 Cena bez DPH [EUR]	SIM Cena bez DPH [EUR]	Terma Split třída I Cena bez DPH [EUR] (nezapomeňte si koupit regulátor KTX)	Smart Split třída I Cena bez DPH [EUR] (nezapomeňte si koupit SMARTWi-Fi regulátor VEO)	Kód produktu ... Kód konfigurace s. 388
915	500	600	473	480	500	451	460	441	425	425	WLWAS091050...
915	600	800	503	510	529	481	490	470	455	455	WLWAS091060...
1110	500	800	495	502	522	473	483	463	448	448	WLWAS111050...
1110	600	800	537	544	564	515	525	505	490	490	WLWAS111060...
1695	500	1200	655	662	–	633	643	623	–	608	WLWAS169050...
1695	600	1200	721	729	–	699	709	689	–	674	WLWAS169060...

Warp T



Barva je zahrnuta v ceně

výběr připojení v ceně

DOPORUČUJEME PRO PŘIPOJENÍ ZX, Z1 i Z8:



Integrovaná sada termostatická,
Chrom

WRZT5G1-CR: 145 EUR

WRZT5G2-CR: 145 EUR

Stránka: 332



Sada krycí integrovaná, Chrom

TGPCR002: 38 EUR

Stránka: 374



Topná tyč KTX4 BLUE, Chrom

WEKT4*: 161 EUR

Stránka: 288



RADIÁTOR VODNÍ / VODNĚ-ELEKTRICKÝ (DOKOUPIT TOPNOU TYČ)

Připojení:



A ↕ [mm]	B ↔ [mm]	75/65/20°C [W]	55/45/20°C [W]	 [W]	Barvy RAL a speciální barvy Cena bez DPH [EUR]	Kód produktu ... Kód konfigurace s. 385
655	500	325	176	300	221	WGWAT065050...
655	600	383	208	400	232	WGWAT065060...
785	500	400	217	400	266	WGWAT078050...
785	600	470	255	400	279	WGWAT078060...
915	500	475	257	400	296	WGWAT091050...
915	600	555	300	600	311	WGWAT091060...
1110	500	553	298	600	305	WGWAT111050...
1110	600	650	350	600	319	WGWAT111060...
1695	500	846	453	800	410	WGWAT169050...
1695	600	1000	535	1000	435	WGWAT169060...

Warp T E



Barva je zahrnuta v ceně



výběr připojení v ceně

RADIÁTOR ELEKTRICKÝ (CENA VČETNĚ NÁPLNĚ A ZVOLENÉ TOPNÉ TYČE)

Připojení:

 E1

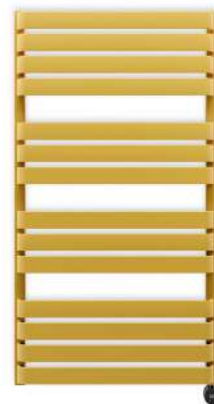
 E8

A ↕ [mm]	B ↔ [mm]	Výkon [W]	MEG Cena bez DPH [EUR]	MOA/DRY/ TDY Cena bez DPH [EUR] (MOA IR: +12 EUR) (MOA BLUE: +38 EUR)	ONE Cena bez DPH [EUR] (Nezabudovaná, v 8cm profilu v barvě radiátoru)	REG 2 Cena bez DPH [EUR]	REG 3 Cena bez DPH [EUR]	SIM Cena bez DPH [EUR]	Terma Split třída I Cena bez DPH [EUR] (nezapomeňte si koupit regulátor KTX)	Smart Split třída I Cena bez DPH [EUR] (nezapomeňte si koupit SMART Wi-Fi regulátor VEO)	Kód produktu ... Kód konfigurace s. 388
655	500	300	316	323	343	293	303	284	269	269	WLWAT065050...
655	600	400	327	334	354	305	314	295	280	280	WLWAT065060...
785	500	400	360	367	387	338	347	327	312	312	WLWAT078050...
785	600	400	373	380	400	351	360	340	325	325	WLWAT078060...
915	500	400	390	397	417	368	377	357	342	342	WLWAT091050...
915	600	600	405	412	432	383	393	373	358	358	WLWAT091060...
1110	500	600	399	407	426	377	387	367	352	352	WLWAT111050...
1110	600	600	414	421	441	392	402	382	367	367	WLWAT111060...
1695	500	800	506	514	533	484	494	474	459	459	WLWAT169050...
1695	600	1000	530	537	557	507	517	498	483	483	WLWAT169060...

Warp T One



Barva je zahrnuta v ceně



výběr připojení v ceně



TRÍDA I



IPx5



2h/1



SADA OBSAHUJE:

Radiátor se zabudovanou topnou tyčí One. Funkce topné tyče ONE: Stránka 205.

DOPORUČUJEME PRO PŘIPOJENÍ S1 i S8:



Integrovaná sada termostatická s ponornou trubicí, Chrom

 WRZT5G5-CR: 151EUR

 WRZT5G6-CR: 151EUR

Stránka: 334



Sada krycí integrovaná, Chrom

TGPCR002: 38EUR

Stránka: 374



Regulátor TTIR1

TGRTBI001: 104EUR

Stránka: 304



RADIÁTOR VODNĚ-ELEKTRICKÝ (CENA VČETNĚ ZABUDOVANÉ TOPNÉ TYČE ONE)

Připojení:



Vyber druh kabelu:



A ↕ [mm]	B ↔ [mm]	75/65/20°C [W]	55/45/20°C [W]	 [W]	Barvy RAL a speciální barvy Cena bez DPH [EUR]	Kód produktu ... Kód konfigurace s. 386
655	500	325	176	300	318	WZWTD065050...
655	600	383	208	400	329	WZWTD065060...
785	500	400	217	400	363	WZWTD078050...
785	600	470	254	400	376	WZWTD078060...
915	500	475	257	400	393	WZWTD091050...
915	600	555	300	600	409	WZWTD091060...
1110	500	553	298	600	402	WZWTD111050...
1110	600	650	350	600	416	WZWTD111060...
1695	500	846	453	800	509	WZWTD169050...
1695	600	1000	535	1000	532	WZWTD169060...

Warp T One E



Barva je zahrnuta v ceně



výběr připojení v ceně



TŘÍDA I



45-60°C/2



P-W-U



120-1000W



IR



IPx5



2h/1



RADIÁTOR ELEKTRICKÝ (CENA VČETNĚ NÁPLNĚ A ZABUDOVANÉ TOPNÉ TYČE ONE)

Připojení:

E1

E8

Vyber druh kabelu:



A ↕ [mm]	B ↔ [mm]	Výkon [W]	Barvy RAL a speciální barvy Cena bez DPH [EUR]	Kód produktu ... Kód konfigurace s.387
785	500	400	381	WWWTN078050...
785	600	400	394	WWWTN078060...
915	500	400	411	WWWTN091050...
915	600	600	426	WWWTN091050...
1110	500	600	420	WWWTN111050...
1110	600	600	435	WWWTN111060...
1695	500	800	527	WWWTN169050...
1695	600	1000	550	WWWTN169060...

Warp T Bold



Barva je zahrnuta v ceně



výběr připojení v ceně

DOPORUČUJEME PRO PŘIPOJENÍ ZX, Z1 i Z8:



Integrovaná sada termostatická,

Chrom

 WRZT5G1-CR: 145 EUR

 WRZT5G2-CR: 145 EUR

Stránka: 332



Sada krycí integrovaná, Chrom

TGPCR002: 38 EUR

Stránka: 374



Topná tyč KTX4, Chrom

WEKT4*: 129 EUR

Stránka: 289



RADIÁTOR VODNÍ / VODNĚ-ELEKTRICKÝ (DOKOUPIT TOPNOU TYČ)

Připojení:



A ↕ [mm]	B ↔ [mm]	75/65/20°C [W]	55/45/20°C [W]	 [W]	Barvy RAL a speciální barvy Cena bez DPH [EUR]	Kód produktu ... Kód konfigurace s. 385
655	500	460	249	400	263	WGWTB065050...
655	600	545	294	600	284	WGWTB065060...
785	500	551	297	600	304	WGWTB078050...
785	600	663	351	600	332	WGWTB078060...
915	500	643	346	600	354	WGWTB091050...
915	600	761	408	800	384	WGWTB091060...
1110	500	780	419	800	377	WGWTB111050...
1110	600	924	491	1000	405	WGWTB111060...
1695	500	1190	636	1200	523	WGWTB169050...
1695	600	1410	746	1500	570	WGWTB169060...

Warp T Bold E



Barva je zahrnuta v ceně



výběr připojení v ceně

RADIÁTOR ELEKTRICKÝ (CENA VČETNĚ NÁPLNĚ A ZABUDOVANÉ TOPNÉ TYČE ONE)

Připojení:



E1

E8



A ↕ [mm]	B ↔ [mm]	Výkon [W]	MEG Cena bez DPH [EUR]	MOA/DRY/ TDY Cena bez DPH [EUR] (MOA IR: +12 EUR) (MOA BLUE: +38 EUR)	ONE Cena bez DPH [EUR] (Nezabudovaná, v 8cm profilu v barvě radiátoru)	REG 2 Cena bez DPH [EUR]	REG 3 Cena bez DPH [EUR]	SIM Cena bez DPH [EUR]	Terma Split třída I Cena bez DPH [EUR] (nezapomeňte si koupit regulátor KTX)	Smart Split třída I Cena bez DPH [EUR] (nezapomeňte si koupit SMART Wi-Fi regulátor VEO)	Kód produktu ... Kód konfigurace s. 388
655	500	400	357	365	384	335	345	325	311	311	WLWTB065050...
655	600	600	377	384	404	355	365	345	330	330	WLWTB065060...
785	500	600	397	404	424	375	385	365	350	350	WLWTB078050...
785	600	800	426	433	452	404	413	393	378	378	WLWTB078060...
915	500	800	448	455	475	426	435	416	401	401	WLWTB091050...
915	600	800	478	485	504	456	465	445	430	430	WLWTB091060...
1110	500	800	472	479	499	450	459	440	425	425	WLWTB111050...
1110	600	1000	500	507	527	478	488	468	453	453	WLWTB111060...
1695	500	1200	618	625	–	596	606	586	–	571	WLWTB169050...
1695	600	1500	–	–	–	–	–	633	–	618	WLWTB169060...

Warp T Bold One

 Barva je zahrnuta v ceně
  výběr připojení v ceně

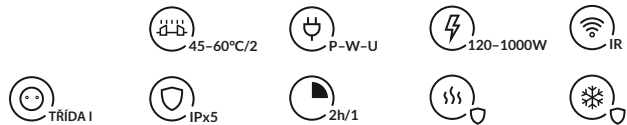

SADA OBSAHUJE:

Radiátor se zabudovanou topnou tyčí One. Funkce topné tyče ONE: Stránka 287.

DOPORUČUJEME PRO PŘIPOJENÍ S1 i S8:



Integrovaná sada termostatická s ponornou trubicí, Chrom

 WRZT5G5-CR: 151EUR

 WRZT5G6-CR: 151EUR

Stránka: 334



Sada krycí integrovaná, Chrom

TGPCR002: 38EUR

Stránka: 374



Regulátor TTIR1

TGRTBI001: 104EUR

Stránka: 304



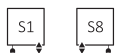

RADIÁTOR VODNĚ-ELEKTRICKÝ (CENA VČETNĚ ZABUDOVANÉ TOPNÉ TYČE ONE)

Připojení:

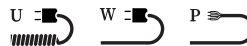

Vyber druh kabelu:



A ↕ [mm]	B ↔ [mm]	75/65/20°C [W]	55/45/20°C [W]	 [W]	Barvy RAL a speciální barvy Cena bez DPH [EUR]	Kód produktu ... Kód konfigurace s. 386
655	500	460	249	400	360	WZWBN065050...
655	600	545	294	600	380	WZWBN065060...
785	500	563	303	600	401	WZWBN078060...
785	600	676	255	800	429	WZWBN078060...
915	500	667	358	800	452	WZWBN091060...
915	600	800	429	800	481	WZWBN091060...
1110	500	780	419	800	474	WZWBN111050...
1110	600	924	491	1000	502	WZWBN111060...

Warp T Bold One E



Barva je zahrnuta v ceně



výběr připojení v ceně



TŘÍDA I



45-60°C/2



P-W-U



120-1000W



IR



IPx5



2h/1



RADIÁTOR ELEKTRICKÝ (CENA VČETNĚ NÁPLNĚ A ZABUDOVANÉ TOPNÉ TYČE ONE)

Připojení:



Vyber druh kabelu:



A ↕ [mm]	B ↔ [mm]	Výkon [W]	Barvy RAL a speciální barvy Cena bez DPH [EUR]	Kód produktu ... Kód konfigurace s. 387
785	500	600	418	WWWBN078050...
785	600	800	447	WWWBN078050...
915	500	800	469	WWWBN915050...
915	600	800	499	WWWBN915050...
1110	500	800	493	WWWBN111050...
1110	600	1000	521	WWWBN111060...



Barva je zahrnuta v ceně



výběr připojení v ceně

DOPORUČUJEME PRO PŘIPOJENÍ ZX:



Integrovaná sada termostatická,

Chrom

WRZT5G1-CR: 145 EUR

WRZT5G2-CR: 145 EUR

Stránka: 332



Sada krycí integrovaná, Chrom

TGPCR002: 38 EUR

Stránka: 374



RADIÁTOR VODNÍ

Připojení:



A ↕ [mm]	B ↔ [mm]	75/65/20°C [W]	55/45/20°C [W]	Barvy RAL a speciální barvy Cena bez DPH [EUR]	Kód produktu ... Kód konfigurace s.385
1300	218	408	212	517	WGWIV130021...
1300	368	681	353	653	WGWIV130036...
1300	518	953	494	826	WGWIV130051...
1300	668	1225	635	1 043	WGWIV130066...
1600	218	503	257	568	WGWIV160021...
1600	368	839	429	723	WGWIV160036...
1600	518	1174	600	923	WGWIV160051...
1600	668	1509	771	1 132	WGWIV160066...
1900	218	617	315	619	WGWIV190021...
1900	368	1028	525	792	WGWIV190036...
1900	518	1439	735	1 019	WGWIV190051...
1900	668	1850	945	1 257	WGWIV190066...



Barva je zahrnuta v ceně

výběr připojení v ceně

DOPORUČUJEME PRO PŘIPOJENÍ Z1, Z8, ZX, Y1, Y8, YP, YL:



Integrovaná sada termostatická,
Chrom

WRZT5G1-CR: 145 EUR

WRZT5G2-CR: 145 EUR

Stránka: 332



Sada krycí integrovaná, Chrom

TGPCR002: 38 EUR

Stránka: 374



Háček bodový ZIP V 30,
Chrom

WRWZIP012 KCRO: 44 EUR

Stránka: 317



RADIÁTOR VODNÍ / VODNĚ-ELEKTRICKÝ (DOKOUPIT TOPNOU TYČ)

Připojení:

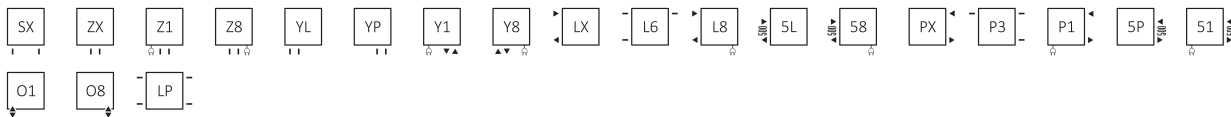

A ↓ [mm]	B ↔ [mm]	Barva ze vzorníku RAL a speciálních barev			Galvanický povrch Chrom			Barvy RAL a speciální barvy Cena bez DPH [EUR]	Chrom Cena bez DPH [EUR]	Kód produktu ... Kód konfigurace s. 385
		75/65/20°C [W]	55/45/20°C [W]	[W]	75/65/20°C [W]	55/45/20°C [W]	[W]			
600	500	248	134	300	174	94	200	301	443	WGZIG060050...
835	500	320	172	300	224	120	200	332	538	WGZIG083050...
1070	500	406	218	400	284	153	300	361	634	WGZIG107050...
1310	500	490	263	600	343	184	400	407	729	WGZIG131050...
1545	500	581	311	600	407	218	400	467	823	WGZIG154050...
1780	500	627	335	600	439	235	400	542	918	WGZIG178050...

ZigZag E



Barva je zahrnuta v ceně



výběr připojení v ceně

RADIÁTOR ELEKTRICKÝ (CENA VČETNĚ NÁPLNĚ A ZVOLENÉ TOPNÉ TYČE)

Připojení:



A ↕ [mm]	B ↔ [mm]	Výkon [W]		MEG		MOA/DRY/TDY		ONE		REG 2		REG 3		SIM		Terma Split třída I		Smart Split třída I		Kód produktu ... Kód konfigurace s. 388
				Cena bez DPH [EUR]		Cena bez DPH [EUR] (MOA IR: + 12 EUR) (MOA BLUE: + 38 EUR)		Cena bez DPH [EUR] (Nezabudovaná, v 8cm profilu v barvě radiátoru)		Cena bez DPH [EUR]		Cena bez DPH [EUR]		Cena bez DPH [EUR]		Cena bez DPH [EUR] (nezapomeňte si koupit regulátor KTX)		Cena bez DPH [EUR] (nezapomeňte si koupit SMART Wi-Fi regulátor VEO)		
		Barva	Chrom	Barvy RAL a speciální barvy	Chrom	Barvy RAL a speciální barvy	Chrom	Barvy RAL a speciální barvy	Chrom	Barvy RAL a speciální barvy	Chrom	Barvy RAL a speciální barvy	Chrom	Barvy RAL a speciální barvy	Chrom	Barvy RAL a speciální barvy	Chrom	Barvy RAL a speciální barvy	Chrom	
600	500	300	200	396	538	403	546	423	565	373	516	383	526	364	506	349	491	349	491	WLZIG060050...
835	500	300	200	426	633	434	640	453	660	404	611	414	621	394	601	380	586	380	586	WLZIG083050...
1070	500	400	300	456	729	463	736	483	756	434	707	443	716	424	697	409	682	409	682	WLZIG107050...
1310	500	600	400	501	823	509	831	528	850	479	801	489	811	469	791	455	777	455	777	WLZIG131050...
1545	500	600	400	562	918	569	925	589	945	539	896	549	906	530	886	515	871	515	871	WLZIG154050...
1780	500	600	400	637	1013	644	1020	664	1040	614	991	624	1000	605	981	590	966	590	966	WLZIG178050...

Příklad radiátoru Tytus One s designově zabudovanou topnou tyčí ONE

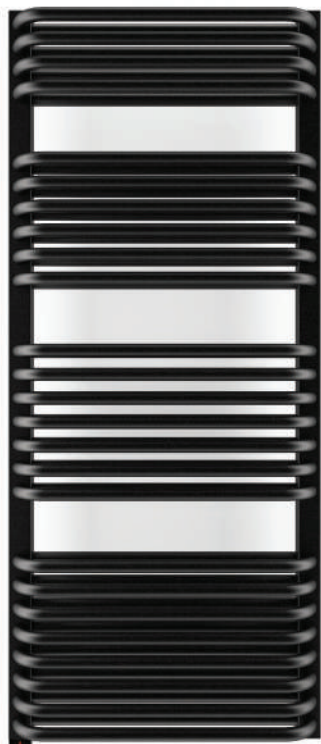

Rozložení teplot v elektrickém radiátoru s topnou tyčí

V elektrickém radiátoru s topným médiem je zdrojem tepla topná tyč, umístěná v jednom z kolektorů. Topný element umístěný v radiátoru zahřívá topné médium, čímž ho nutí cirkulovat v radiátoru. Molekuly zahřátého média, stoupají vzhůru a díky vlastním pohybům, se mísí s chladnými kapalinovými molekulami (takzvaným difúzním jevem) pohybují se a dál předávají teplo ve vodorovných trubkách radiátoru. O odevzdané teplo ochlazená kapalina klesá do spodních částí radiátoru tak, aby mohla po zahřátí znovu stoupat a předávat teplo v radiátoru (obrázek napravo).

Závěrem: Kolektor, ve kterém je umístěna topná tyč, bude vždy nejteplejším prvkem radiátoru (zejména jeho horní část) zatímco spodní trubky zůstanou chladnější. Tento jev je normální.

Poznámka: Pokud je topná tyč ONE zabudovaná skrytě přímo v kolektoru radiátoru (nikoli přes T-kus nebo ventil), zůstávají až 4 nejnižší radiátorové trubky chladné, protože používáme

dodatečnou ochranu topných prvků nebo regulátoru (mrtvá zóna topného tělesa). Získáme tak čistý design radiátoru, nenarušený vyčnívající topnou tyčí, na úkor obětování 4 spodních trubek, které budou chladné.

U elektrických radiátorů, které nejsou připojeny k vodním ÚT rozvodům, může díky vzduchovému polštáři ponechanému pro tepelnou roztažnost kapalného média a bezpečnost radiátoru zůstat horní profil chladný, zejména při nižších teplotních nastaveních zařízení. Proto ani u jiných radiátorů na trhu, které nejsou z výroby uzavřeny a vyžaduje se u vodních např. doplnění destilované vody při úbytku média, neplňte radiátory až po napouštěcí otvory se zátkou. Radiátory od nás vyrobeny jako čistě elektrické jsou naplněny olejem a uzavřené, proto nevyžadují pravidelné doplňování.

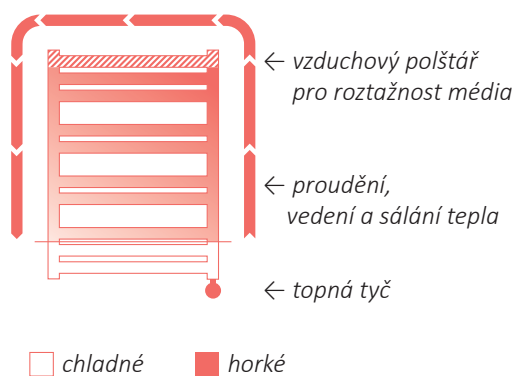



SMART WI-FI

Radiátor VOLTAN



Barva je zahrnuta v ceně



výběr připojení v ceně

ELEKTRICKÝ WI-FI PŘÍMOTOP

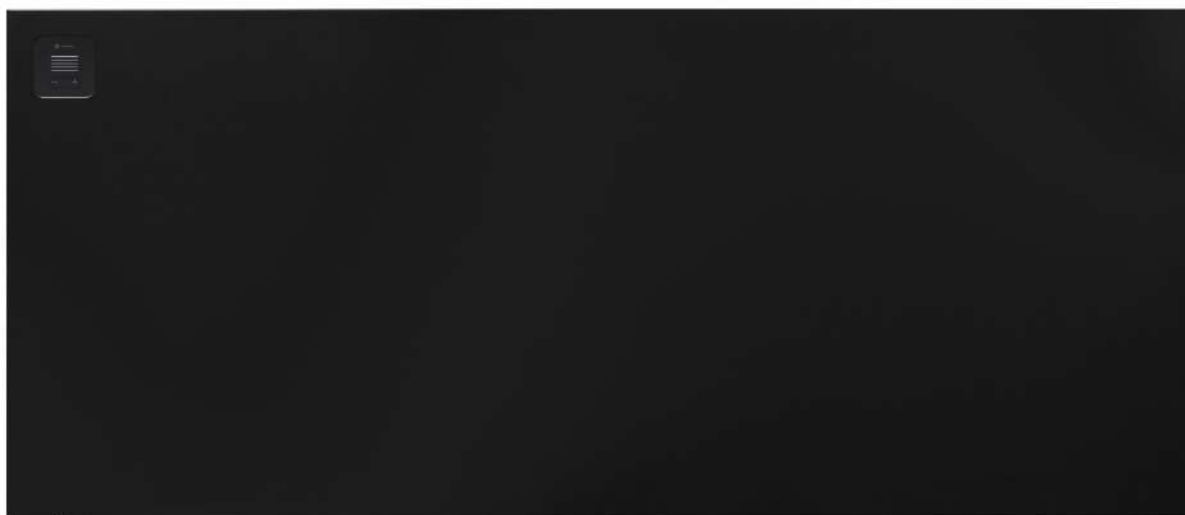

Připojení:



Vyber Druh kabelu:



APLIKACE PRO REGULOVÁNÍ TERMA SMART:



A ⇕	B ↔	 [W]	Váha [kg]	Cena bez DPH [EUR]	Kód produktu ... Kód konfigurace s. 392
500	660	1kW	8	330	WKVTN050066...
500	1160	2kW	11	360	WKVTN050116...

DOSTUPNÝ VE VŠECH BARVÁCH KROMĚ BLACK CROCODILE NEW A BAREV PREMIUM

Topná tyč Wi-Fi VEO



BAREVNÉ KOMBINACE

BARVA ČELNÍ PLOCHY A TĚLA:



OZDOBNÉ BOČNÍ KRYTY:



+ BARVY PREMIUM

PŘEHLED KONFIGURACÍ

REGULÁTOR BEZ TOPNÉHO ELEMENTU

Kód balení
Kód druhu kabelu
WE **VEO** **K** **WWX** **W**
Kód modelu
Kód barvy

APLIKACE PRO REGULOVÁNÍ TERMA SMART:



Model	Obal	Barva čelní plochy	Barva bočních krytů	Druh kabelu	Cena bez DPH [EUR]
WE VEO	K Kartón	W Bílá B Černá	WX Bílá BX Černá SX Stříbrná CX Chrom BGR Bottle Green MDN Midnight BBS Brushed Brass BRA Brass CPG Champagne PER Pers OBZ Old Bronze TCG True Copper Bright RWE Red Wine RAW Raw Metal MAV Metal Alive SVR Silver	W Rovný kabel se zástrčkou 1,5m P Přímý kabel do zdi bez zástrčky 1,5m U Kroucený kabel se zástrčkou 0,45m S Bez kabelu (kabel ze zdi zapojit v krytce do svorkovnice tyče)	156

DOPORUČUJEME:

Topný element SS1
WESS1*: 33 EUR

SS1: viz s. 230



Smart Split třída 1

Topný element SS1 a regulátory VEO tvoří 2 části kompletní topné tyče Wi-Fi VEO



Název	Výkon [W]	Cena bez DPH [EUR]	Kód produktu	Kód konfigurace
Smart Split třída 1	120	33	WESS101	K---D
Smart Split třída 1	200	33	WESS102	K---D
Smart Split třída 1	300	33	WESS103	K---D
Smart Split třída 1	400	33	WESS104	K---D
Smart Split třída 1	600	33	WESS106	K---D
Smart Split třída 1	800	33	WESS108	K---D
Smart Split třída 1	1000	33	WESS110	K---D
Smart Split třída 1	1500	33	WESS115	K---D
Smart Split třída 1	1800	33	WESS118	K---D
Smart Split třída 1	2000	33	WESS120	K---D

Termostatická hlavice Wi-Fi VAZ



BAREVNÉ KOMBINACE

BARVA ČELNÍ PLOCHY A TĚLA:



OZDOBNÉ BOČNÍ KRYTY:



+ BARVY PREMIUM



Termostatická hlavice Wi-Fi VAZ

PŘEHLED KONFIGURACÍ



APLIKACE PRO REGULOVÁNÍ TERMA SMART:



Model	Obal	Barva čelní plochy	Barva bočních krytů	Třída ochrany	Cena bez DPH [EUR]
WI VAZ	K Kartón	W Bílá B Černá	WX Bílá BX Černá SX Stříbrná CX Chrom BGR Bottle Green MDN Midnight BBS Brushed Brass BRA Brass CPG Champagne PER Pers OBZ Old Bronze TCG True Copper Bright RWE Red Wine RAW Raw Metal MAV Metal Alive SVR Silver	Třída I	145

ADAPTÉRY:



Adaptér pro termostatickou hlavici VAZ na ventil RAV



Adaptér pro termostatickou hlavici VAZ na ventil M28x1,5



Adaptér pro termostatickou hlavici VAZ na ventil RAVL



Adaptér pro termostatickou hlavici VAZ na ventil RA

Model	Barva	Cena bez DPH [EUR]	Kód produktu
RAV	Chrom	7	TGD003
M28	Chrom	7	TGD004
RAVL	Chrom	7	TGD002
RA	Chrom	7	TGD001

Senzor otevření okna Wi-Fi VOS



PŘEHLED KONFIGURACÍ:

Model	Barva	Cena bez DPH [EUR]	Kód produktu	Kód konfigurace
VOS	Bílá	75	WIVOS	K916
VOS	Stříbrná polomat	75	WIVOS	KSMA

Senzor teploty a vlhkosti Wi-Fi VTS



PŘEHLED KONFIGURACÍ:

Model	Barva	Cena bez DPH [EUR]	Kód produktu	Kód konfigurace
VTS	Bílá	75	WIVTS	K916
VTS	Stříbrná polomat	75	WIVTS	KSMA

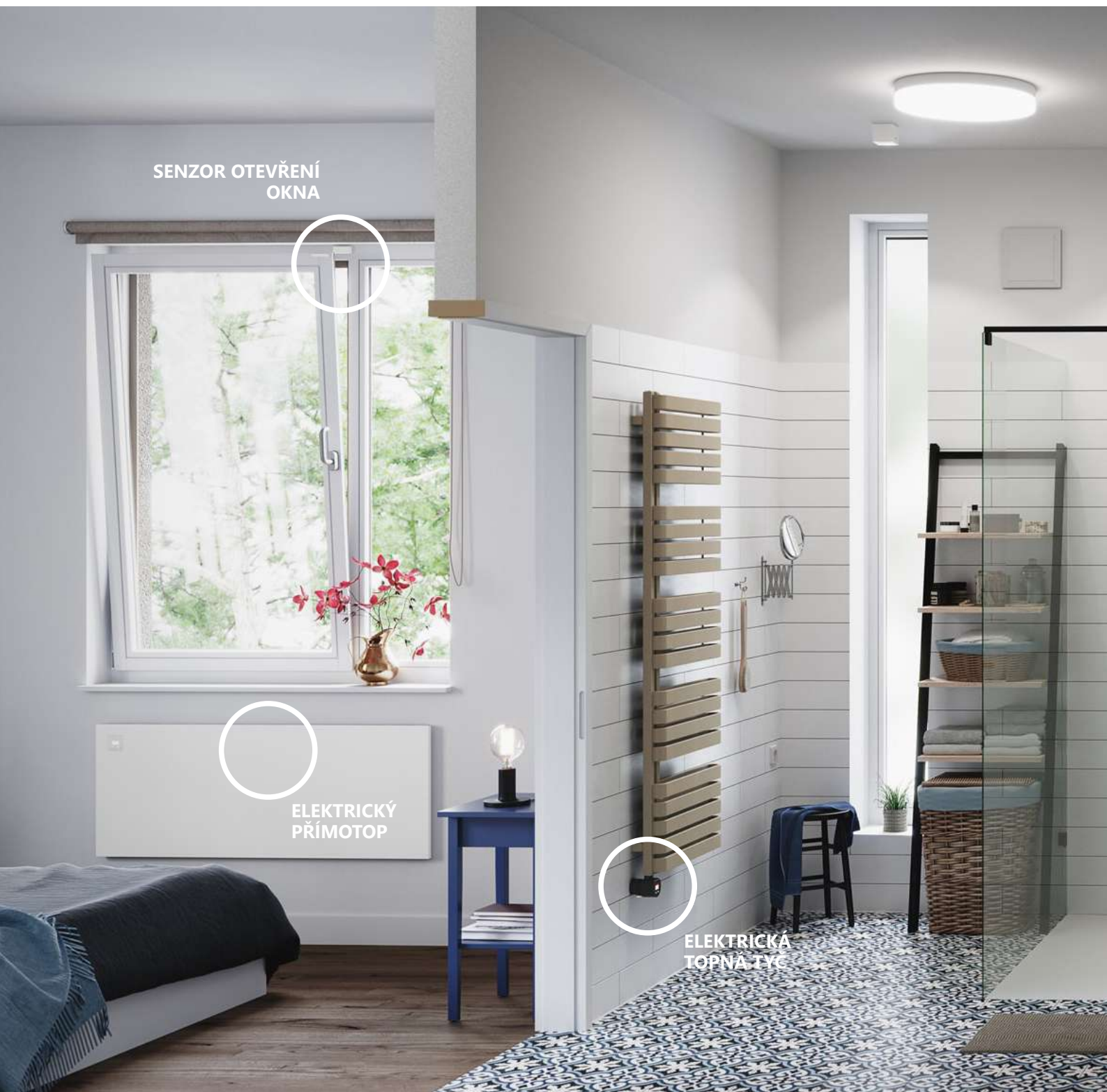

SENZOR OTEVŘENÍ
OKNA

ELEKTRICKÝ
PŘÍMOTOP

ELEKTRICKÁ
TOPNÁ TYČ

SYSTÉM TERMA SMART WI-FI JE:

- inovační systém vytápění místností se samoučícím se algoritmem
- možnost individuálního rozšiřování systému Wi-Fi online regulace vytápění za pomoci 3 Wi-Fi zařízení a 2 Wi-Fi senzorů
- sada zjednoduší šetření energiemi, např. pomocí nastavení režimu vytápění, časového harmonogramu kdy má topit, nebo kontrolou otevření oken
- aktivně přizpůsobuje výkon vytápění venkovnímu počasí



- inteligentní snížení teploty prázdného domu a zvýšení, kdy se do domu vrací obyvatelé
- možnost online kontroly a nastavování systému přes Internet z celého světa
- funkce Child lock (Rodičovského zámku) na všech zařízeních
- Úspora: Není potřeba kupovat a instalovat Centrální řídicí jednotku s displejem. Vše ovládáte přes svůj dotykový telefon.

Blower





BAREVNOST
BARVA VENTILÁTORU:



DRUHY KABELU:



PŘEHLED KONFIGURACÍ:

A ↕	B ↔	Hloubka G [mm]	Barva	Výkon  [W]	Váha  [kg]	Úchyty	Cena bez DPH [EUR]	Kód produktu	Kód konfigurace
239	400	95	bílá	podle topné tyče	2,35	Kulaté a ploché	300	WEBL1	K916
239	400	95	šedá	podle topné tyče	2,35	Kulaté a ploché	300	WEBL1	K906

Alex Blower



Barva je zahrnuta v ceně

ELEKTRICKÝ RADIÁTOR S VENTILÁTOREM

Připojení:

E8



PRODUKT SE SKLÁDÁ ZE 2 ČÁSTÍ

ČÁST 1 - ELEKTRICKÝ RADIÁTOR

Výška A ↕ [mm]	Šířka B ↔ [mm]	Výkon radiátoru s Blower [W]	Výkon radiátoru Chrom s Blower [W]	Barvy RAL a speciální barvy Cena bez DPH [EUR]	Chrom Cena bez DPH [EUR]	Kód produktu ... Kód konfigurace s. 388
760	500	400	-	295	463	WLA8E076050...
760	600	500	400	309	492	WLA8E076050...
1140	500	600	400	345	608	WLA8E114050...
1140	600	800	600	363	651	WLA8E114060...
1580	500	800	600	391	753	WLA8E158050...
1580	600	1000	600	412	811	WLA8E158060...
1580	700	1000	800	436	835	WLA8E158070...

ČÁST 2 - VENTILÁTOR BLOWER pro rychlé vyhřátí místnosti (Stránka. 272)

City Blower



Barva je zahrnuta v ceně

ELEKTRICKÝ RADIÁTOR S VENTILÁTOREM

Připojení:

E8

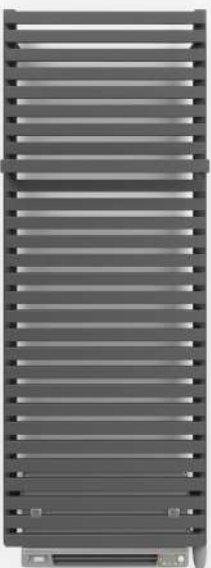

PRODUKT SE SKLÁDÁ ZE 2 ČÁSTÍ

ČÁST 1 - ELEKTRICKÝ RADIÁTOR

Výška A ↕ [mm]	Šířka B ↔ [mm]	Výkon radiátoru s Blower [W]	Barvy RAL a speciální barvy Cena bez DPH [EUR]	Kód produktu ... Kód konfigurace s. 388
780	500	400	402	WLC8T078050...
780	600	600	418	WLC8T078060...
1050	500	600	433	WLC8T105050...
1050	600	800	453	WLC8T105060...
1320	500	800	466	WLC8T132050...
1320	600	800	486	WLC8T132060...
1590	500	800	498	WLC8T159050...
1590	600	1000	523	WLC8T159060...
1860	500	1000	533	WLC8T186050...

ČÁST 2 - VENTILÁTOR BLOWER pro rychlé vyhřátí místnosti (Stránka. 272)

Fiona Blower



Barva je zahrnuta v ceně

ELEKTRICKÝ RADIÁTOR S VENTILÁTOREM

Připojení:

E8



PRODUKT SE SKLÁDÁ ZE 2 ČÁSTÍ

ČÁST 1 – ELEKTRICKÝ RADIÁTOR

Výška A ↕ [mm]	Šířka B ↔ [mm]	Výkon radiátoru s Blower [W]	Výkon radiátoru Chrom s Blower [W]	Barvy RAL a speciální barvy Cena bez DPH [EUR]	Chrom Cena bez DPH [EUR]	Kód produktu ... Kód konfigurace: 388
1620	500	800	400	346	734	WLF8N162050...
1620	600	800	600	359	808	WLF8N162060...
1860	500	800	–	362	–	WLF8N186050...
1860	600	1000	–	379	–	WLF8N186060...

ČÁST 2 - VENTILÁTOR BLOWER pro rychlé vyhřátí místnosti (Stránka. 272)

Lima Blower



Barva je zahrnuta v ceně

ELEKTRICKÝ RADIÁTOR S VENTILÁTOREM

Připojení:

E8



PRODUKT SE SKLÁDÁ ZE 2 ČÁSTÍ

ČÁST 1 – ELEKTRICKÝ RADIÁTOR

Výška A ↕ [mm]	Šířka B ↔ [mm]	Výkon radiátoru s Blower [W]	Výkon radiátoru Chrom s Blower [W]	Barvy RAL a speciální barvy Cena bez DPH [EUR]	Chrom Cena bez DPH [EUR]	Kód produktu ... Kód konfigurace: 388
820	500	400	–	287	–	WLL8M082050...
820	600	400	400	299	595	WLL8M082060...
820	700	600	400	315	626	WLL8M082070...
1140	500	600	400	330	626	WLL8M114050...
1140	600	800	400	345	656	WLL8M114060...
1140	700	800	600	361	701	WLL8M114070...
1460	500	800	600	345	685	WLL8M146050...
1460	600	800	600	358	716	WLL8M146060...
1460	700	1000	800	389	745	WLL8M146070...
1700	500	800	600	386	745	WLL8M170050...
1700	600	1000	800	412	806	WLL8M170060...
1700	700	–	800	–	865	WLL8M170070...

ČÁST 2 - VENTILÁTOR BLOWER pro rychlé vyhřátí místnosti (Stránka. 272)

Marlin Blower



Barva je zahrnuta v ceně

ELEKTRICKÝ RADIÁTOR S VENTILÁTOREM

Připojení:

E8



PRODUKT SE SKLÁDÁ ZE 2 ČÁSTÍ

ČÁST 1 – ELEKTRICKÝ RADIÁTOR

Výška A ↕ [mm]	Šířka B ↔ [mm]	Výkon radiátoru s Blower [W]	Výkon radiátoru Chrom s Blower [W]	Barvy RAL a speciální barvy Cena bez DPH [EUR]	Chrom Cena bez DPH [EUR]	Kód produktu ... Kód konfigurace: 388
780	530	400	–	322	–	WLM8R078053...
780	630	400	–	336	–	WLM8R078063...
1185	530	600	400	370	657	WLM8R118053...
1185	630	800	400	381	691	WLM8R118063...
1680	530	800	600	461	806	WLM8R168053...
1680	630	1000	800	481	858	WLM8R168063...

ČÁST 2 - VENTILÁTOR BLOWER pro rychlé vyhřátí místnosti [\(Stránka. 272\)](#)

Pola Blower



Barva je zahrnuta v ceně

ELEKTRICKÝ RADIÁTOR S VENTILÁTOREM

Připojení:

E8



PRODUKT SE SKLÁDÁ ZE 2 ČÁSTÍ

ČÁST 1 – ELEKTRICKÝ RADIÁTOR

Výška A ↕ [mm]	Šířka B ↔ [mm]	Výkon radiátoru s Blower [W]	Výkon radiátoru Chrom s Blower [W]	Barvy RAL a speciální barvy Cena bez DPH [EUR]	Chrom Cena bez DPH [EUR]	Kód produktu ... Kód konfigurace: 388
1180	500	600	400	335	731	WLP8L118050...
1180	600	800	600	352	776	WLP8L118060...
1580	500	800	600	372	977	WLP8L158050...
1580	600	1000	800	407	1 038	WLP8L158060...

ČÁST 2 - VENTILÁTOR BLOWER pro rychlé vyhřátí místnosti [\(Stránka. 272\)](#)

Quadrus Bold Blower



Barva je zahrnuta v ceně

ELEKTRICKÝ RADIÁTOR S VENTILÁTOREM

Připojení:

E8



PRODUKT SE SKLÁDÁ ZE 2 ČÁSTÍ

ČÁST 1 – ELEKTRICKÝ RADIÁTOR

Výška A ↕ [mm]	Šířka B ↔ [mm]	Výkon radiátoru s Blower [W]	Barvy RAL a speciální barvy Cena bez DPH [EUR]	Kód produktu ... Kód konfigurace s. 388
870	600	800	508	WLQ8B087060...
1185	500	1000	524	WLQ8B118050...
1185	600	1000	574	WLQ8B118060...

ČÁST 2 - VENTILÁTOR BLOWER pro rychlé vyhřátí místnosti ([Stránka. 272](#))

Quadrus Slim Blower



Barva je zahrnuta v ceně

ELEKTRICKÝ RADIÁTOR S VENTILÁTOREM

Připojení:

E8

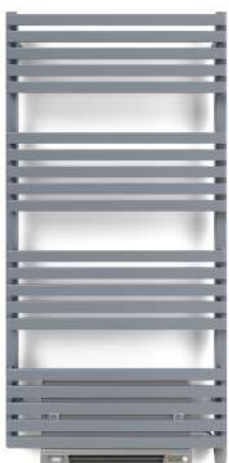

PRODUKT SE SKLÁDÁ ZE 2 ČÁSTÍ

ČÁST 1 – ELEKTRICKÝ RADIÁTOR

Výška A ↕ [mm]	Šířka B ↔ [mm]	Výkon radiátoru s Blower [W]	Barvy RAL a speciální barvy Cena bez DPH [EUR]	Kód produktu ... Kód konfigurace s. 388
870	450	400	395	WLQ8S087050...
870	600	600	411	WLQ8S087060...
1185	450	600	428	WLQ8S118045...
1185	600	800	461	WLQ8S118060...

ČÁST 2 - VENTILÁTOR BLOWER pro rychlé vyhřátí místnosti ([Stránka. 272](#))

Tytus Blower



Barva je zahrnuta v ceně

ELEKTRICKÝ RADIÁTOR S VENTILÁTOREM

Připojení:

E8



PRODUKT SE SKLÁDÁ ZE 2 ČÁSTÍ

ČÁST 1 – ELEKTRICKÝ RADIÁTOR

Výška A ↕ [mm]	Šířka B ↔ [mm]	Výkon radiátoru s Blower [W]	Barvy RAL a speciální barvy Cena bez DPH [EUR]	Kód produktu ... Kód konfigurace s. 388
820	540	600	401	WLT8T082054...
820	640	800	417	WLT8T082064...
1020	540	800	444	WLT8T102054...
1020	640	1000	471	WLT8T102064...
1260	540	1000	499	WLT8T126054...

ČÁST 2 - VENTILÁTOR BLOWER pro rychlé vyhřátí místnosti ([Stránka. 272](#))

Warp T Blower



Barva je zahrnuta v ceně

ELEKTRICKÝ RADIÁTOR S VENTILÁTOREM

Připojení:

E8



PRODUKT SE SKLÁDÁ ZE 2 ČÁSTÍ

ČÁST 1 – ELEKTRICKÝ RADIÁTOR

Výška A ↕ [mm]	Šířka B ↔ [mm]	Výkon radiátoru s Blower [W]	Barvy RAL a speciální barvy Cena bez DPH [EUR]	Kód produktu ... Kód konfigurace s. 388
785	500	400	349	WLW8T078050...
785	600	400	362	WLW8T078060...
915	500	400	379	WLW8T091050...
915	600	600	395	WLW8T091060...
1110	500	600	389	WLW8T111050...
1110	600	600	404	WLW8T111060...
1695	500	800	496	WLW8T169050...
1695	600	1000	519	WLW8T169060...

ČÁST 2 - VENTILÁTOR BLOWER pro rychlé vyhřátí místnosti ([Stránka. 272](#))

Warp T Bold Blower



Barva je
zahrnuta v ceně

ELEKTRICKÝ RADIÁTOR S VENTILÁTOREM

Připojení:

E8



PRODUKT SE SKLÁDÁ ZE 2 ČÁSTÍ

ČÁST 1 - ELEKTRICKÝ RADIÁTOR

Výška A ⇕ [mm]	Šířka B ↔ [mm]	Výkon radiátoru s Blower [W]	Barvy RAL a speciální barvy Cena bez DPH [EUR]	Kód produktu ... Kód konfigurace s. 388
785	500	600	387	WLW8B078050...
785	600	600	415	WLW8B078060...
1110	500	800	461	WLW8B111050...
1110	600	1000	490	WLW8B111060...

ČÁST 2 - VENTILÁTOR BLOWER pro rychlé vyhřátí místnosti ([Stránka. 272](#))



Elektrické topné tyče

Možnosti připojení topné tyče do radiátoru ÚT

Široká škála připojovacích otvorů v radiátorech TERMA umožňuje rozšířit funkce radiátoru ÚT i o topnou tyč. Tato kombinace přináší mnoho výhod. Především:

- K sušení mokrých oděvů, nebo jako sušák na ručníky, v i mimo topné období (např. v létě plavky). Pokud chcete šetřit své peníze, nastavte si na mnoha našich regulacích topných tyčí jednoduše čas sušení např. na 2h, což by mělo průměrně stačit k usušení ručníku.
- Schopnost ohřívat pokoj (např. koupelnu) během podzimních a jarních přechodů, aniž by musela běžet celá soustava ÚT, což u dálkového vytápění v bytech stejně nejde a radiátor ÚT s topnou tyčí nebo přímo jen radiátor s topnou tyčí označovaný jako „Elektrický radiátor“ je jedinou možností. U soustav vytápěných kotle, není potřeba spouštět pro krátkodobou tepelnou pohodu a udržovat celou soustavu předčasně a dusit kotel na minimální výkon jen pro přitápění.
- Většinou v projektech není koupelna dimenzovaná na tepelnou pohodu 24°C, proto je dobré si přitápět topným žebříkem.
- Pokud topný žebřík překryjete věcmi k usušení, ztratí po dobu zakrytí až 90% svého výkonu k vytápění prostoru. **PROTO VŽDY VOLTE VĚTŠÍ ROZMĚRY TOPNÝCH ŽEBŘÍKŮ S VĚTŠÍMI VÝKONY!**

Vše o instalacích a návodech k jednoduché obsluze topných tyčí se dočtete na stránkách www.termaheat.com. Doporučené metody instalace topné tyče do radiátoru jsou znázorněny v následujících výkresech.

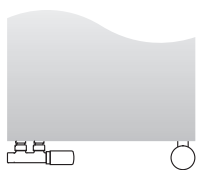

připojení topné tyče přímo do volného 1/2" otvoru. Radiátor na vodu ÚT připojen pomocí komplexního integrovaného termostatického ventilu] Připojení Z1, Z8, Y8, Y1

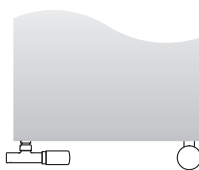

[Obr. 2 - připojení topné tyče přímo do volného 1/2" otvoru. Radiátor ÚT připojen pomocí komplexního integrovaného termostatického ventilu s ponornou trubicí] Připojení SX, S1, S8

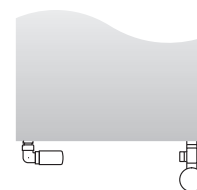

[Obrázek 3 - připojení topné tyče pomocí integrovaného uzavíracího ventilu s T- kusem] Připojení SX

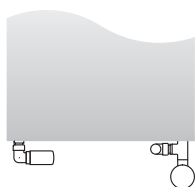

[Obr. 4 - připojení topné tyče pomocí T- kusu a uzavíracího ventilu] Připojení SX

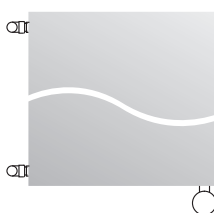

[Obr. 5 - připojení topné tyče přímo do radiátoru ÚT s bočním připojením k instalaci.] Připojení L8, P1, S8, S1

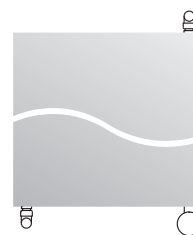

[Obr. 6 - připojení topné tyče přímo do radiátoru ÚT s protirohovým vstupem a výstupem topné vody] Připojení GD, UN, UC

Při použití topné tyče v radiátoru ÚT by jeden z ventilů měl zůstat vždy otevřený, což zabrání stoupání tlaku během provozu topné tyče a poškození radiátoru nebo topné tyče.

Topné tyče TERMA splňují všechny nezbytné požadavky evropských norem v oblasti bezpečnosti a ochrany uživatele před nebezpečím popálení. Z tohoto důvodu je důležité nedovolit, aby teplota vody vzrostla nad 82 ° C v topném okruhu s nainstalovaným radiátorem s topnou tyčí, protože by mohlo dojít k poškození tepelné pojistky v topné tyči.

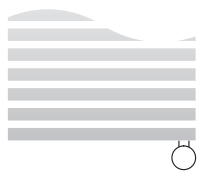

[Obr. 7 - připojení topné tyče zespodu do sloupku, kolmo na horizontální trubky radiátoru]
Připojení E1, E8, EX

Rozložení a hodnota teploty na povrchu elektrického radiátoru závisí na mnoha faktorech. Geometrie radiátoru je základní. Topná tyč by měl být vždy přišroubována ke spodní části radiátoru.

Topná tyč je prvek vyčnívající poza obrys radiátoru. Z tohoto důvodu je důležité pamatovat na správné umístění topné tyče tak, aby se minimalizovalo riziko mechanického poškození tělesa topné tyče (nestavějte na topné tyče nebo nevěšejte na ně žádné předměty).

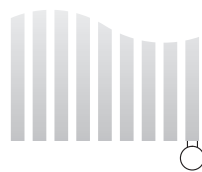

[Obr. 8 - připojení topné tyče zespodu, rovnoběžně se svislými příčkami radiátoru]

Všechny čistě elektrické radiátory si můžete od společnosti TERMA zakoupit ve 2 variantách:

1. Sušák ručníků a oděvů nebo jako
2. Elektrický radiátor sloužící k vytápění místnosti. V tomto případě si zakupte topnou tyč i s týdenním regulátorem TTIR1 nebo zvolte tyč s aplikací do telefonu Terma BlueLine Next, kde vhodným týdenním programem šetříte svou peněženku i životní prostředí.

Aplikace pro dálkové ovládání topných tyčí Terma BlueLine Next - KTX4 BLUE a MOA BLUE



Funkce a výhody:

- Využívejte pokročilou technologii Bluetooth s nízkou spotřebou energie
- Užívejte si intuitivní nastavování a ovládání topných tyčí Terma BlueLine Next
- K dispozici pro všechny mobilní zařízení s Android 4.0 a novější nebo iOS 6 a novější
- Spravujte více radiátorů s topnými tyčemi najednou
- Aplikace ekonomicky vyhodnotí rozdílné příkazy mezi více uživateli
- Tvořte a ukládejte si vlastní týdenní plány vytápění a libovolně mezi nimi přepínejte (např. týdenní plán pracovní týden, plán volný týden a týdenní plán dovolená)







K dispozici je ke stažení ovládací aplikace:



Elektrické topné tyče - vlastnosti a funkce

	SIM	REG 3	REG 2	MEG	MOA	MOA IR	
Typ regulátoru	Teplota topného tělesa	Teplota topného tělesa	Teplota topného tělesa / místnosti	Teplota topného tělesa	Teplota topného tělesa	Teplota topného tělesa / místnosti ^{[1][2]}	
Nastavení teploty / mezistupně	65°C/1	50-65°C/2	65° C / 1	30-60° C /5	30-60° C /5	30-60° C /5	
Symetrický kryt (instalace na levé a pravé straně topného tělesa)	✓	✓	✓	✓	✓	✓	
Druhy kabelů (připojení)	P/R	P/W/U	P/W/T/R	W/M/U	W/M/U	W/M/U	
Třída ochrany zařízení	Třída I	Třída I	Třída I	Třída I	Třída I	Třída I	
Stupeň ochrany / krytí	IP67	IPx5	IPx5	IPx4	IPx5	IPx5	
Odnímatelný topný prvek (tyč ze 2ks) (Terma-Split System)	–	–	–	–	–	–	
Elektronický snímač teploty	–	–	–	✓	✓	✓	
Dostupný topný výkon	100 - 1500 [W]	120 - 1200 [W]	120 - 1200 [W]	120 - 1200 [W]	120 - 1200 [W]	120 - 1200 [W]	
Sušení ručníků max. v h / mezistupně	–	–	–	–	2h/-	2h/-	
Harmonogram denní	–	–	–	–	–	✓ ^[1]	
Harmonogram týdenní	–	–	–	–	–	✓ ^[2]	
Bezdrátový komunikační modul	–	–	–	–	–	IR	
Aktivní ochranu proti práci v suchém radiátoru	–	–	–	✓	✓	✓	
Počítadlo provozních hodin	–	–	–	–	–	–	
ANTIFREEZE chrání proti zamrznutí	–	–	–	✓	✓	✓	
Dvojitá ochrana proti přehřátí (přehřátí a ohněm)	✓	✓	✓	✓	✓	✓	
V souladu se směrnicemi EU 2009/125/WE a 2015/1188	–	–	–	–	–	✓ ^[2]	

Legenda:

-  P — Přímý kabel do zdi bez zástrčky 1,5m
-  R — Rovný kabel se zástrčkou a vypínačem
-  S — Bez kabelu (připojit kabel ze zdi v krytce do svorkovnice tyče)
-  T — Kroucený kabel se zástrčkou 0,45m a vypínačem
-  U — Kroucený kabel se zástrčkou 0,45m
-  W — Rovný kabel se zástrčkou 1,5m
-  M — Přímý kabel do zdi bez zástrčky 1,5m s krytem
- L — Bez kabelu (připojit kabel ze zdi v krytce do svorkovnice tyče pro RETRO, RIBBON V E, SIMPLE DW, SHERWOOD V a V E), TRIGA AN E a TUNE VWD a VWD E)

	MOA Blue	DRY (TDY)	KTX 1	KTX 2	KTX 3	KTX 4	KTX 4 Blue	One	DTIR	TTIR
	Teplota topného tělesa / místnosti	Teplota topného tělesa	Tepelný výkon	Teplota topného tělesa.	Teplota topného tělesa	Teplota topného tělesa / místnosti ^{[1][2]}	Teplota místnosti /topného tělesa	Teplota topného tělesa / místnosti ^{[1][2]}	Teplota místnosti	
	15-30° C / 5 ^[4] 30-60° C / 5 ^[4]	48° C (42-60)	-/2 ^[3]	30-60° C / 5	30-60° C / 30	30-60° C / 5	15-30° C / 5 ^[4] 30-60° C / 5 ^[4]	45-60° C / 2	5-30° C	10-30° C
	✓	✓	✓	✓	✓	✓	✓	✓ ^[6]	–	
	W/M/U	W/M/U	P/W/U/S	P/W/U/S	P/W/U/S	P/W/U/S	P/W/U/S	P/W/U/M	–	
	Třída I	Třída I	Třída I	Třída I	Třída I	Třída I	Třída I	Třída I	Třída III	
	IPx5	IPx5	IPx4	IPx5 ^[7]	IPx5 ^[7]	IPx5 ^[7]	IPx5 ^[7]	IPx5	IP30	
	–	–	✓	✓	✓	✓	✓	–	–	
	✓	✓	✓	✓	✓	✓	✓	✓	✓	
	120 - 1200 [W]	120 - 1200 [W]	120 - 1000 [W]	120 - 1000 [W]	120 - 1000 [W]	120 - 1000 [W]	120 - 1000 [W]	120 - 1000 [W]	–	
	24h/48	5h/5 (3h/3)	–	2h/-	4h/8	4h/4	24h/48	2h/-	4h/16	4h/8
	✓	–	–	–	✓ ^[5]	✓ ^[1]	✓	✓ ^[2]	✓	–
	✓	–	–	–	–	✓ ^[2]	✓	✓ ^[2]	–	✓
	BLE	–	–	–	–	IR	BLE	IR	IR	IR
	✓	✓	–	–	✓	✓	✓	✓	–	
	–	–	–	–	–	✓	✓	–	–	
	✓	✓	✓	✓	✓	✓	✓	✓	✓	
	✓	✓	✓	✓	✓	✓	✓	✓	–	
	✓	–	–	–	–	✓ ^[2]	✓	✓ ^[2]	–	

1 Pouze pokud je topná tyč připojena k dálkovému Regulátoru DTIR1

2 Pouze pokud je topná tyč připojena k dálkovému Regulátoru TTIR1

3 Regulace výkonu topení 50/100

4 Aplikace pro ovládání Bluetooth umožňuje nastavit teplotu v krocích po 1°C.

5 Zjednodušené denní hodiny 4 časové zóny

6 Neplatí u lichoběžníkového a D profilu

7 Verze s připojením S má IPx4



NOVINKA

Název	Výkon [W]	Bílá Cena bez DPH [EUR]	Barvy RAL a speciální barvy Cena bez DPH [EUR]	Chrom Cena bez DPH [EUR]	Kód produktu ... Kód konfigurace
ONE D profil 30x40 levá	120	112	122	127	WEODL01...
ONE D profil 30x40 levá	200	112	122	127	WEODL02...
ONE D profil 30x40 levá	300	112	122	127	WEODL03...
ONE D profil 30x40 levá	400	112	122	127	WEODL04...
ONE D profil 30x40 levá	600	112	122	127	WEODL06...
ONE D profil 30x40 levá	800	112	122	127	WEODL08...
ONE D profil 30x40 levá	1000	112	122	127	WEODL10...
ONE D profil 30x40 pravá	120	112	122	127	WEODP01...
ONE D profil 30x40 pravá	200	112	122	127	WEODP02...
ONE D profil 30x40 pravá	300	112	122	127	WEODP03...
ONE D profil 30x40 pravá	400	112	122	127	WEODP04...
ONE D profil 30x40 pravá	600	112	122	127	WEODP06...
ONE D profil 30x40 pravá	800	112	122	127	WEODP08...
ONE D profil 30x40 pravá	1000	112	122	127	WEODP10...
ONE 30x30	120	112	122	127	WEOKX01...
ONE 30x30	200	112	122	127	WEOKX02...
ONE 30x30	300	112	122	127	WEOKX03...
ONE 30x30	400	112	122	127	WEOKX04...
ONE 30x30	600	112	122	127	WEOKX06...
ONE 30x30	800	112	122	127	WEOKX08...
ONE 30x30	1000	112	122	127	WEOKX10...
ONE 30x40	120	112	122	127	WEOPX01...
ONE 30x40	200	112	122	127	WEOPX02...
ONE 30x40	300	112	122	127	WEOPX03...
ONE 30x40	400	112	122	127	WEOPX04...
ONE 30x40	600	112	122	127	WEOPX06...
ONE 30x40	800	112	122	127	WEOPX08...
ONE 30x40	1000	112	122	127	WEOPX10...
ONE T 36x40 levá	120	112	122	127	WEOTL01...
ONE T 36x40 levá	200	112	122	127	WEOTL02...
ONE T 36x40 levá	300	112	122	127	WEOTL03...
ONE T 36x40 levá	400	112	122	127	WEOTL04...
ONE T 36x40 levá	600	112	122	127	WEOTL06...
ONE T 36x40 levá	800	112	122	127	WEOTL08...
ONE T 36x40 levá	1000	112	122	127	WEOTL10...
ONE T 36x40 pravá	120	112	122	127	WEOTP01...
ONE T 36x40 pravá	200	112	122	127	WEOTP02...
ONE T 36x40 pravá	300	112	122	127	WEOTP03...
ONE T 36x40 pravá	400	112	122	127	WEOTP04...
ONE T 36x40 pravá	600	112	122	127	WEOTP06...
ONE T 36x40 pravá	800	112	122	127	WEOTP08...
ONE T 36x40 pravá	1000	112	122	127	WEOTP10...
ONE kulatá R36	120	112	122	127	WEORX01...
ONE kulatá R36	200	112	122	127	WEORX02...
ONE kulatá R36	300	112	122	127	WEORX03...

Název	Výkon [W]	Bílá Cena bez DPH [EUR]	Barvy RAL a speciální barvy Cena bez DPH [EUR]	Chrom Cena bez DPH [EUR]	Kód produktu ... Kód konfigurace
ONE kulatá R36	400	112	122	127	WEORX04...
ONE kulatá R36	600	112	122	127	WEORX06...
ONE kulatá R36	800	112	122	127	WEORX08...
ONE kulatá R36	1000	112	122	127	WEORX10...

PŘEHLED KONFIGURACÍ:

Kód výkonu
Kód barvy
WE / ODL / 04 / T / CRO / W
Kód modelu
Kód balení
Kód druhu kabelu

	Model	Výkon [W]	Obal	Barva	Druh kabelu
WE	ODL ONE D levá	01 120	T Tuba	916 Bílá	W Rovný kabel se zástrčkou 1,5m P Přímý kabel do zdi bez zástrčky 1,5m U Kroucený kabel se zástrčkou 0,45m M Přímý kabel do zdi bez zástrčky 1,5m s krytem <small>Pro radiátory RETRO, RIBBON V E, všech ROLO, SHERWOOD V a V E, SIMPLE DW, objednejte pro M kabel navíc delší krytku 70 - 88mm WRMAONE001 kulatou nebo WRMAONE002 hranatou Pro radiátory TRIGA AN E, TUNE VWD a VWD E objednejte navíc delší krytku 88 - 106mm WRMAONE003 kulatou nebo WRMAONE004 hranatou. Ceníková cena všech krytek 15 EUR bez DPH</small>
	ODP ONE D pravá	02 200		CRO Chrom	
	OKX ONE 30x30	03 300		... nebo jiné ze vzorníku s. 16-28	
	OPX ONE 30x40	04 400			
	OTL ONE T levá	06 600			
	OTP ONE T pravá	08 800			
	ORX ONE R36	10 1000			

DOPORUČUJEME:



Regulátor DTIR1
TGRDSI001: 78 EUR
DTIR1: viz s. 305



Regulátor TTIR1
TGRBTI001: 104 EUR
TTIR1: viz s. 304

FUNKCE TOPNÉ TYČE ONE:



45-60°C/2



24h/7



120-1000W



TŘÍDA I



Aktivní ochrana proti práci v suchém radiátoru



24h



23,6°C



P-W-U-M



IR



2h/-



IPx5



Funkce antifreeze proti zamrznutí

KTX 4 BLUE



Název	Výkon [W]	Bílá Cena bez DPH [EUR]	Černá Cena bez DPH [EUR]	Stříbrná Cena bez DPH [EUR]	Chrom Cena bez DPH [EUR]	Kód produktu ... Kód konfigurace
KTX 4 BLUE Regulátor	–	123	131	131	137	WEK4B ...
KTX4 BLUE Regulátor + Terma Split třída I (TS1)	120 – 1000	148	154	154	161	WEK4B ...

PŘEHLED KONFIGURACÍ (ŘADA KTX TYČÍ SE SKLÁDÁ ZE 2 ČÁSTÍ - TOPNÉHO ELEMENTU TS1 A REGULÁTORU):

REGULÁTOR BEZ TOPNÉHO ELEMENTU

WE / K4B / K / SMA / W

Kód balení / *Kód barvy*
Kód modelu / *Kód druhu kabelu*

REGULÁTOR S TOPNÝM ELEMENTEM TS1

WE / K4B / 04 / T / SMA / W

Kód výkonu / *Kód barvy*
Kód modelu / *Kód balení* / *Kód druhu kabelu*

Model	Výkon [W]	Obal	Barva	Druh kabelu
WE K4B KTX4 BLUE	bez topného elementu	K Kartón	916 Bílá SMA Stříbrná CRO Chrom 905 Černá	W Rovný kabel se zástrčkou 1,5m P Přímý kabel do zdi bez zástrčky 1,5m U Kroucený kabel se zástrčkou 0,45m
WE K4B KTX4 BLUE	01 120 02 200 03 300 04 400 06 600 08 800 10 1000	T Tuba	916 Bílá SMA Stříbrná CRO Chrom 905 Černá	W Rovný kabel se zástrčkou 1,5m P Přímý kabel do zdi bez zástrčky 1,5m U Kroucený kabel se zástrčkou 0,45m

APLIKACE PRO DÁLKOVÉ OVLÁDÁNÍ
TERMA BLUE:





Všechny tyče TERMA vyrábíme s kabelem vycházejícím z tyče, jen u řady KTX s krytkou, kabel vyvést ze zdi a dopojit do KTX regulátoru a objednat v kódu kryt kabelu S

Název	Výkon [W]	Bílá Cena bez DPH [EUR]	Černá Cena bez DPH [EUR]	Stříbrná Cena bez DPH [EUR]	Chrom Cena bez DPH [EUR]	Zlatá Cena bez DPH [EUR]	Kód produktu ... Kód konfigurace
KTX 4 Regulátor	–	88	95	95	102	120	WEKT4 ...
KTX4 Regulátor + Terma Split třída I (TS1)	120 – 1000	113	121	121	129	147	WEKT4 ...

PŘEHLED KONFIGURACÍ (ŘADA KTX TYČÍ SE SKLÁDÁ ZE 2 ČÁSTÍ - TOPNÉHO ELEMENTU TS1 A REGULÁTORU):

REGULÁTOR BEZ TOPNÉHO ELEMENTU

REGULÁTOR S TOPNÝM ELEMENTEM TS1

WE / ^{Kód balení}KT4 / ^{Kód barvy}K / SMA / ^{Kód modelu}W

WE / ^{Kód výkonu}KT4 / ^{Kód balení}04 / ^{Kód barvy}T / SMA / ^{Kód druhu kabelu}W

Model	Výkon [W]	Obal	Barva	Druh kabelu
WE KT4 KTX 4	bez topného elementu	K Kartón	916 Bílá	W Rovný kabel se zástrčkou 1,5m
			SMA Stříbrná	P Přímý kabel do zdi bez zástrčky 1,5m
			CRO Chrom	U Kroucený kabel se zástrčkou 0,45m
			905 Černá	S Bez kabelu (kabel ze zdi zapojit v krytce do svorkovnice tyče)
			GPO Zlatá	
WE KT4 KTX 4	01 120 02 200 03 300 04 400 06 600 08 800 10 1000	T Tuba	916 Bílá	W Rovný kabel se zástrčkou 1,5m
			SMA Stříbrná	P Přímý kabel do zdi bez zástrčky 1,5m
			CRO Chrom	U Kroucený kabel se zástrčkou 0,45m
			905 Černá	S Bez kabelu (kabel ze zdi zapojit v krytce do svorkovnice tyče)
			GPO Zlatá	

DOPORUČUJEME:

Regulátor DTIR1
TGRDSI001: 78 EUR



DTIR1: viz s. 305

Regulátor TTIR1
TGRTB1001: 104 EUR



TTIR1: viz s. 304

KTX 3



Všechny tyče TERMA vyrábíme s kabelem vycházejícím z tyče, jen u řady KTX s krytkou, kabel vyvěst ze zdi a dopojit do KTX regulátoru a objednat v kódu kryt kabelu S

Název	Výkon [W]	Bílá Cena bez DPH [EUR]	Černá Cena bez DPH [EUR]	Stříbrná Cena bez DPH [EUR]	Chrom Cena bez DPH [EUR]	Zlatá Cena bez DPH [EUR]	Kód produktu ... Kód konfigurace
KTX 3 Regulátor	–	88	95	95	102	120	WEKT3...
KTX 3 Regulátor + Terma Split třída I (TS1)	120 – 1000	113	121	121	129	147	WEKT3...

PŘEHLED KONFIGURACÍ (ŘADA KTX TYČÍ SE SKLÁDÁ ZE 2 ČÁSTÍ - TOPNÉHO ELEMENTU TS1 A REGULÁTORU): REGULÁTOR BEZ TOPNÉHO ELEMENTU

WE / KT3 / K / SMA / W

Kód modelu / Kód druhu kabelu / Kód balení / Kód barvy

REGULÁTOR S TOPNÝM ELEMENTEM TS1

WE / KT3 / 04 / T / SMA / W

Kód modelu / Kód výkonu / Kód balení / Kód druhu kabelu / Kód barvy

Model	Výkon [W]	Obal	Barva	Druh kabelu
WE KT3 KTX 3	bez topného elementu	K Kartón	916 Bílá SMA Stříbrná CRO Chrom 905 Černá GPO Zlatá	W Rovný kabel se zástrčkou 1,5m P Přímý kabel do zdi bez zástrčky 1,5m U Kroucený kabel se zástrčkou 0,45m S Bez kabelu (kabel ze zdi zapojit v krytce do svorkovnice tyče)
WE KT3 KTX 3	01 120 02 200 03 300 04 400 06 600 08 800 10 1000	T Tuba	916 Bílá SMA Stříbrná CRO Chrom 905 Černá GPO Zlatá	W Rovný kabel se zástrčkou 1,5m P Přímý kabel do zdi bez zástrčky 1,5m U Kroucený kabel se zástrčkou 0,45m S Bez kabelu (kabel ze zdi zapojit v krytce do svorkovnice tyče)

KTX 2



Všechny tyče TERMA vyrábíme s kabelem vycházejícím z tyče, jen u řady KTX s krytkou, kabel vyvést ze zdi a dopojit do KTX regulátoru a objednat v kódu kryt kabelu S

Název	Výkon [W]	Bílá Cena bez DPH [EUR]	Černá Cena bez DPH [EUR]	Stříbrná Cena bez DPH [EUR]	Chrom Cena bez DPH [EUR]	Zlatá Cena bez DPH [EUR]	Kód produktu ... Kód konfigurace
KTX 2 Regulátor	–	75	81	81	85	102	WEKT2...
KTX 2 Regulátor + Terma Split třída I (TS1)	120 – 1000	102	107	107	112	129	WEKT2...

PŘEHLED KONFIGURACÍ (ŘADA KTX TYČÍ SE SKLÁDÁ ZE 2 ČÁSTÍ - TOPNÉHO ELEMENTU TS1 A REGULÁTORU):

REGULÁTOR BEZ TOPNÉHO ELEMENTU

WE / KT2 / K / SMA / W

Kód balení / Kód barvy
Kód modelu / Kód druhu kabelu

REGULÁTOR S TOPNÝM ELEMENTEM TS1

WE / KT2 / 04 / T / SMA / W

Kód výkonu / Kód barvy
Kód modelu / Kód balení / Kód druhu kabelu

Model	Výkon [W]	Obal	Barva	Druh kabelu
WE KT2 KTX 2	bez topného elementu	K Kartón	916 Bílá SMA Stříbrná CRO Chrom 905 Černá GPO Zlatá	W Rovný kabel se zástrčkou 1,5m P Přímý kabel do zdi bez zástrčky 1,5m U Kroucený kabel se zástrčkou 0,45m S Bez kabelu (kabel ze zdi zapojit v krytce do svorkovnice tyče)
WE KT2 KTX 2	01 120 02 200 03 300 04 400 06 600 08 800 10 1000	T Tuba	916 Bílá SMA Stříbrná CRO Chrom 905 Černá GPO Zlatá	W Rovný kabel se zástrčkou 1,5m P Přímý kabel do zdi bez zástrčky 1,5m U Kroucený kabel se zástrčkou 0,45m S Bez kabelu (kabel ze zdi zapojit v krytce do svorkovnice tyče)

KTX 1



Všechny tyče TERMA vyrábíme s kabelem vycházejícím z tyče, jen u řady KTX s krytkou, kabel vyvěst ze zdi a dopojit do KTX regulátoru a objednat v kódu kryt kabelu S

Název	Výkon [W]	Bílá Cena bez DPH [EUR]	Černá Cena bez DPH [EUR]	Stříbrná Cena bez DPH [EUR]	Chrom Cena bez DPH [EUR]	Zlatá Cena bez DPH [EUR]	Kód produktu ... Kód konfigurace
KTX 1 Regulátor	–	67	68	68	70	89	WEKT1 ...
KTX 1 Regulátor + Terma Split třída I (TS1)	120 – 1000	92	95	95	97	116	WEKT1 ...

PŘEHLED KONFIGURACÍ (ŘADA KTX TYČÍ SE SKLÁDÁ ZE 2 ČÁSTÍ - TOPNÉHO ELEMENTU TS1 A REGULÁTORU):

REGULÁTOR BEZ TOPNÉHO ELEMENTU

WE / KT1 / K / SMA / W

Kód balení / Kód barvy / Kód modelu / Kód druhu kabelu

REGULÁTOR S TOPNÝM ELEMENTEM TS1

WE / KT1 / 04 / T / SMA / W

Kód výkonu / Kód barvy / Kód modelu / Kód balení / Kód druhu kabelu

Model	Výkon [W]	Obal	Barva	Druh kabelu
WE KT1 KTX 1	bez topného elementu	K Kartón	916 Bílá SMA Stříbrná CRO Chrom 905 Černá GPO Zlatá	W Rovný kabel se zástrčkou 1,5m P Přímý kabel do zdi bez zástrčky 1,5m U Kroucený kabel se zástrčkou 0,45m S Bez kabelu (kabel ze zdi zapojit v krytce do svorkovnice tyče)
WE KT1 KTX 1	01 120 02 200 03 300 04 400 06 600 08 800 10 1000	T Tuba	916 Bílá SMA Stříbrná CRO Chrom 905 Černá GPO Zlatá	W Rovný kabel se zástrčkou 1,5m P Přímý kabel do zdi bez zástrčky 1,5m U Kroucený kabel se zástrčkou 0,45m S Bez kabelu (kabel ze zdi zapojit v krytce do svorkovnice tyče)

MOA BLUE



Název	Výkon [W]	Bílá Cena bez DPH [EUR]	Černá Cena bez DPH [EUR]	Stříbrná Cena bez DPH [EUR]	Chrom Cena bez DPH [EUR]	Kód produktu ... Kód konfigurace
MOA BLUE	120	133	137	137	142	WEMOB01 ...
MOA BLUE	200	133	137	137	142	WEMOB02 ...
MOA BLUE	300	133	137	137	142	WEMOB03 ...
MOA BLUE	400	133	137	137	142	WEMOB04 ...
MOA BLUE	600	133	137	137	142	WEMOB06 ...
MOA BLUE	800	133	137	137	142	WEMOB08 ...
MOA BLUE	1000	133	137	137	142	WEMOB10 ...
MOA BLUE	1200	133	137	137	142	WEMOB12 ...
MOA BLUE + T- kus	120	137	142	142	147	WEMBT01 ...
MOA BLUE + T- kus	200	137	142	142	147	WEMBT02 ...
MOA BLUE + T- kus	300	137	142	142	147	WEMBT03 ...
MOA BLUE + T- kus	400	137	142	142	147	WEMBT04 ...
MOA BLUE + T- kus	600	137	142	142	147	WEMBT06 ...
MOA BLUE + T- kus	800	137	142	142	147	WEMBT08 ...
MOA BLUE + T- kus	1000	137	142	142	147	WEMBT10 ...
MOA BLUE + T- kus	1200	137	142	142	147	WEMBT12 ...

PŘEHLED KONFIGURACÍ:



APLIKACE PRO DÁLKOVÉ OVLÁDÁNÍ TERMA BLUE:



Model	Výkon [W]	Obal	Barva	Druh kabelu
WE / MOB / MOA BLUE	01 120	F Fólie	916 Bílá	W Rovný kabel se zástrčkou 1,5m
WE / MBT / MOA BLUE + T- kus	02 200	T Tuba	SMA Stříbrná	M Přímý kabel do zdi bez zástrčky 1,5m s krytem
	03 300		CRO Chrom	U Kroucený kabel se zástrčkou 0,45m
	04 400		905 Černá	
	06 600			
	08 800			
	10 1000			
	12 1200			



Název	Výkon [W]	Bílá Cena bez DPH [EUR]	Černá Cena bez DPH [EUR]	Stříbrná Cena bez DPH [EUR]	Chrom Cena bez DPH [EUR]	Zlatá Cena bez DPH [EUR]	Kód produktu ... Kód konfigurace
MOA IR	120	105	110	110	117	129	WEMOR01...
MOA IR	200	105	110	110	117	129	WEMOR02...
MOA IR	300	105	110	110	117	129	WEMOR03...
MOA IR	400	105	110	110	117	129	WEMOR04...
MOA IR	600	105	110	110	117	129	WEMOR06...
MOA IR	800	105	110	110	117	129	WEMOR08...
MOA IR	1000	105	110	110	117	129	WEMOR10...
MOA IR	1200	105	110	110	117	129	WEMOR12...
MOA IR + T- kus	120	110	115	115	122	142	WEMRT01...
MOA IR + T- kus	200	110	115	115	122	142	WEMRT02...
MOA IR + T- kus	300	110	115	115	122	142	WEMRT03...
MOA IR + T- kus	400	110	115	115	122	142	WEMRT04...
MOA IR + T- kus	600	110	115	115	122	142	WEMRT06...
MOA IR + T- kus	800	110	115	115	122	142	WEMRT08...
MOA IR + T- kus	1000	110	115	115	122	142	WEMRT10...
MOA IR + T- kus	1200	110	115	115	122	142	WEMRT12...

PŘEHLED KONFIGURACÍ:



Model	Výkon [W]	Obal	Barva	Druh kabelu
WE MOR MOA IR	01 120	F Fólie	916 Bílá	W Rovný kabel se zástrčkou 1,5m
MRT MOA IR + T- kus	02 200	T Tuba	SMA Stříbrná	M Přímý kabel do zdi bez zástrčky 1,5m s krytem
	03 300		CRO Chrom	U Kroucený kabel se zástrčkou 0,45m
	04 400		905 Černá	
	06 600		GPO Zlatá	
	08 800			
	10 1000			
	12 1200			

DOPORUČUJEME:

Regulátor DTIR1
TGRDSI001: 78 EUR

DTIR1: viz s. 305



Regulátor TTIR1
TGRBTI001: 104 EUR

TTIR1: viz s. 304



MOA



Název	Výkon [W]	Bílá Cena bez DPH [EUR]	Černá Cena bez DPH [EUR]	Stříbrná Cena bez DPH [EUR]	Chrom Cena bez DPH [EUR]	Zlatá Cena bez DPH [EUR]	Kód produktu ... Kód konfigurace
MOA	120	95	99	99	105	117	WEMOA01...
MOA	200	95	99	99	105	117	WEMOA02...
MOA	300	95	99	99	105	117	WEMOA03...
MOA	400	95	99	99	105	117	WEMOA 04...
MOA	600	95	99	99	105	117	WEMOA06...
MOA	800	95	99	99	105	117	WEMOA08...
MOA	1000	95	99	99	105	117	WEMOA10...
MOA	1200	95	99	99	105	117	WEMOA12...
MOA + T- kus	120	99	104	104	110	127	WEMAT01...
MOA + T- kus	200	99	104	104	110	127	WEMAT02...
MOA + T- kus	300	99	104	104	110	127	WEMAT03...
MOA + T- kus	400	99	104	104	110	127	WEMAT04...
MOA + T- kus	600	99	104	104	110	127	WEMAT06...
MOA + T- kus	800	99	104	104	110	127	WEMAT08...
MOA + T- kus	1000	99	104	104	110	127	WEMAT10...
MOA + T- kus	1200	99	104	104	110	127	WEMAT12...

PŘEHLED KONFIGURACÍ:

Kód výkonu
Kód barvy
Kód druhu kabelu
WE / MAT / 04 / T / SMA / W
Kód modelu
Kód balení

Model	Výkon [W]	Obal	Barva	Druh kabelu
WE MOA MOA	01 120	F Fólie	916 Bílá	W Rovný kabel se zástrčkou 1,5m
MAT MOA + T- kus	02 200	T Tuba	SMA Stříbrná	M Přímý kabel do zdi bez zástrčky 1,5m s krytem
	03 300		CRO Chrom	U Kroucený kabel se zástrčkou 0,45m
	04 400		905 Černá	
	06 600		GPO Zlatá	
	08 800			
	10 1000			
	12 1200			

DRY



Název	Výkon [W]	Bílá Cena bez DPH [EUR]	Černá Cena bez DPH [EUR]	Stříbrná Cena bez DPH [EUR]	Chrom Cena bez DPH [EUR]	Zlatá Cena bez DPH [EUR]	Kód produktu ... Kód konfigurace
DRY	120	95	99	99	105	117	WEDRY01...
DRY	200	95	99	99	105	117	WEDRY02...
DRY	300	95	99	99	105	117	WEDRY03...
DRY	400	95	99	99	105	117	WEDRY04...
DRY	600	95	99	99	105	117	WEDRY06...
DRY	800	95	99	99	105	117	WEDRY08...
DRY	1000	95	99	99	105	117	WEDRY10...
DRY	1200	95	99	99	105	117	WEDRY12...
DRY + T- kus	120	99	104	104	110	127	WEDYT01...
DRY + T- kus	200	99	104	104	110	127	WEDYT02...
DRY + T- kus	300	99	104	104	110	127	WEDYT03...
DRY + T- kus	400	99	104	104	110	127	WEDYT04...
DRY + T- kus	600	99	104	104	110	127	WEDYT06...
DRY + T- kus	800	99	104	104	110	127	WEDYT08...
DRY + T- kus	1000	99	104	104	110	127	WEDYT10...
DRY + T- kus	1200	99	104	104	110	127	WEDYT12...

PŘEHLED KONFIGURACÍ:



Model	Výkon [W]	Obal	Barva	Druh kabelu
WE DRY DRY	01 120	F Fólie	916 Bílá	W Rovný kabel se zástrčkou 1,5m
DYT DRY + T- kus	02 200	T Tuba	SMA Stříbrná	M Přímý kabel do zdi bez zástrčky 1,5m s krytem
	03 300		CRO Chrom	U Kroucený kabel se zástrčkou 0,45m
	04 400		905 Černá	
	06 600		GPO Zlatá	
	08 800			
	10 1000			
	12 1200			



Název	Výkon [W]	Bílá Cena bez DPH [EUR]	Černá Cena bez DPH [EUR]	Stříbrná Cena bez DPH [EUR]	Chrom Cena bez DPH [EUR]	Zlatá Cena bez DPH [EUR]	Kód produktu ... Kód konfigurace
TDY	120	92	96	96	102	111	WETDY01...
TDY	200	92	96	96	102	111	WETDY02...
TDY	300	92	96	96	102	111	WETDY03...
TDY	400	92	96	96	102	111	WETDY04...
TDY	600	92	96	96	102	111	WETDY06...
TDY	800	92	96	96	102	111	WETDY08...
TDY	1000	92	96	96	102	111	WETDY10...
TDY	1200	92	96	96	102	111	WETDY12...
TDY + T- kus	120	96	101	101	107	121	WETYT01...
TDY + T- kus	200	96	101	101	107	121	WETYT02...
TDY + T- kus	300	96	101	101	107	121	WETYT03...
TDY + T- kus	400	96	101	101	107	121	WETYT04...
TDY + T- kus	600	96	101	101	107	121	WETYT06...
TDY + T- kus	800	96	101	101	107	121	WETYT08...
TDY + T- kus	1000	96	101	101	107	121	WETYT10...
TDY + T- kus	1200	96	101	101	107	121	WETYT12...

PŘEHLED KONFIGURACÍ:



Model	Výkon [W]	Obal	Barva	Druh kabelu
WE TDY TDY	01 120	F Fólie	916 Bílá	W Rovný kabel se zástrčkou 1,5m
TYT TDY + T- kus	02 200	T Tuba	SMA Stříbrná	M Přímý kabel do zdi bez zástrčky 1,5m s krytem
	03 300		CRO Chrom	U Kroucený kabel se zástrčkou 0,45m
	04 400		905 Černá	
	06 600		GPO Zlatá	
	08 800			
	10 1000			
	12 1200			



Název	Výkon [W]	Bílá Cena bez DPH [EUR]	Černá Cena bez DPH [EUR]	Stříbrná Cena bez DPH [EUR]	Chrom Cena bez DPH [EUR]	Zlatá Cena bez DPH [EUR]	Kód produktu ... Kód konfigurace
MEG	120	90	92	92	97	108	WEMEG01...
MEG	200	90	92	92	97	108	WEMEG02...
MEG	300	90	92	92	97	108	WEMEG03...
MEG	400	90	92	92	97	108	WEMEG04...
MEG	600	90	92	92	97	108	WEMEG06...
MEG	800	90	92	92	97	108	WEMEG08...
MEG	1000	90	92	92	97	108	WEMEG10...
MEG	1200	90	92	92	97	108	WEMEG12...
MEG + T- kus	120	94	97	97	101	117	WEMGT01...
MEG + T- kus	200	94	97	97	101	117	WEMGT02...
MEG + T- kus	300	94	97	97	101	117	WEMGT03...
MEG + T- kus	400	94	97	97	101	117	WEMGT04...
MEG + T- kus	600	94	97	97	101	117	WEMGT06...
MEG + T- kus	800	94	97	97	101	117	WEMGT08...
MEG + T- kus	1000	94	97	97	101	117	WEMGT10...
MEG + T- kus	1200	94	97	97	101	117	WEMGT12...

PŘEHLED KONFIGURACÍ:

Kód výkonu
Kód druhu kabelu
WE / MEG / 04 / T / SMA / W
Kód modelu
Kód balení
Kód barvy

Model	Výkon [W]	Obal	Barva	Druh kabelu
WE MEG MEG	01 120	F Fólie	916 Bílá	W Rovný kabel se zástrčkou 1,5m
MGT MEG + T- kus	02 200	T Tuba	SMA Stříbrná	M Přímý kabel do zdi bez zástrčky 1,5m s krytem
	03 300		CRO Chrom	U Kroucený kabel se zástrčkou 0,45m
	04 400		905 Černá	
	06 600		GPO Zlatá	
	08 800			
	10 1000			
	12 1200			

REG 3



Název	Výkon [W]	Bílá Cena bez DPH [EUR]	Černá Cena bez DPH [EUR]	Stříbrná Cena bez DPH [EUR]	Chrom Cena bez DPH [EUR]	Kód produktu ... Kód konfigurace
REG 3	120	78	81	81	84	WER3G01...
REG 3	200	78	81	81	84	WER3G02...
REG 3	300	78	81	81	84	WER3G03...
REG 3	400	78	81	81	84	WER3G04...
REG 3	600	78	81	81	84	WER3G06...
REG 3	800	78	81	81	84	WER3G08...
REG 3	1000	78	81	81	84	WER3G10...
REG 3	1200	78	81	81	84	WER3G12...
REG 3 + T- kus	120	83	85	85	88	WER3T01...
REG 3 + T- kus	200	83	85	85	88	WER3T02...
REG 3 + T- kus	300	83	85	85	88	WER3T03...
REG 3 + T- kus	400	83	85	85	88	WER3T04...
REG 3 + T- kus	600	83	85	85	88	WER3T06...
REG 3 + T- kus	800	83	85	85	88	WER3T08...
REG 3 + T- kus	1000	83	85	85	88	WER3T10...
REG 3 + T- kus	1200	83	85	85	88	WER3T12...

PŘEHLED KONFIGURACÍ:



Model	Výkon [W]	Obal	Barva	Druh kabelu
WE R3G REG 3	01 120	F Fólie	916 Bílá	W Rovný kabel se zástrčkou 1,5m
R3T REG 3 + T- kus	02 200	T Tuba	SMA Stříbrná	P Přímý kabel do zdi bez zástrčky 1,5m
	03 300		CRO Chrom	U Kroucený kabel se zástrčkou 0,45m
	04 400		905 Černá	
	06 600			
	08 800			
	10 1000			
	12 1200			

REG 2



Název	Výkon [W]	Bílá Cena bez DPH [EUR]	Černá Cena bez DPH [EUR]	Stříbrná Cena bez DPH [EUR]	Chrom Cena bez DPH [EUR]	Kód produktu ... Kód konfigurace
REG 2	120	75	76	76	78	WER2G01...
REG 2	200	75	76	76	78	WER2G02...
REG 2	300	75	76	76	78	WER2G03...
REG 2	400	75	76	76	78	WER2G04...
REG 2	600	75	76	76	78	WER2G06...
REG 2	800	75	76	76	78	WER2G08...
REG 2	1000	75	76	76	78	WER2G10...
REG 2	1200	75	76	76	78	WER2G12...
REG 2 + T- kus	120	80	81	81	83	WER2T01...
REG 2 + T- kus	200	80	81	81	83	WER2T02...
REG 2 + T- kus	300	80	81	81	83	WER2T03...
REG 2 + T- kus	400	80	81	81	83	WER2T04...
REG 2 + T- kus	600	80	81	81	83	WER2T06...
REG 2 + T- kus	800	80	81	81	83	WER2T08...
REG 2 + T- kus	1000	80	81	81	83	WER2T10...
REG 2 + T- kus	1200	80	81	81	83	WER2T12...

PŘEHLED KONFIGURACÍ:



Model	Výkon [W]	Obal	Barva	Druh kabelu
WE R2G REG 2	01 120	F Fólie	916 Bílá	P Přímý kabel do zdi bez zástrčky 1,5m
R2T REG 2 + T- kus	02 200	T Tuba	SMA Stříbrná	R Rovný kabel se zástrčkou s vypínačem 1,5m
	03 300		CRO Chrom	T Kroucený kabel se zástrčkou 0,45m s vypínačem
	04 400		905 Černá	W Rovný kabel se zástrčkou 1,5m (pro vypnutí vytažovat ze zásuvky)
	06 600			
	08 800			
	10 1000			
	12 1200			



Název	Výkon [W]	Nerezová ocel s bílým/šedým kabelem bez zástrčky Cena bez DPH [EUR]	Nerezová ocel s bílým/šedým kabelem se zástrčkou Cena bez DPH [EUR]	Kód produktu ... Kód konfigurace
SIM	100	61	61	WESIM01...
SIM	150	—	—	WESIM51...
SIM	200	61	61	WESIM02...
SIM	300	61	61	WESIM03...
SIM	400	61	61	WESIM04...
SIM	500	—	—	WESIM05...
SIM	600	61	61	WESIM06...
SIM	800	61	61	WESIM08...
SIM	1000	67	67	WESIM10...
SIM	1200	67	67	WESIM12...
SIM	1500	67	67	WESIM15...

PŘEHLED KONFIGURACÍ:



Model			Výkon [W]		Obal		Barva		Druh kabelu	
WE	SIM	SIM	01	100	F	Fólie	INX	Nerezová ocel s bílým kabelem	R	Rovný kabel se zástrčkou s vypínačem 1,5m
			51	150			INS	Nerezová ocel s šedým kabelem	P	Přímý kabel do zdi bez zástrčky 1,5m
			02	200						
			03	300						
			04	400						
			05	500						
			06	600						
			08	800						
			10	1000						
			12	1200						
			15	1500						

Krytka SIM

Krytka topné tyče SIM, pro ukrytí připojení rovného kabelu bez zástrčky do zdi. V designu pro radiátory s kulatým i hranatým profilem, proveditelná v barvě radiátoru, aby elegantně ukryla topnou tyč a kabel.



MOŽNOSTI BAREVNÝCH ÚPRAV:

vzorník RAL, Speciálních barev, barev Premium, Chrom



URČENÁ PRO TOPNÉ TYČE:

SIM

Velikost ↔	Barva	Cena bez DPH [EUR] u barev Premium +25%	Kód produktu ... Kód konfigurace s. 390
84mm kulatá	Barvy RAL, Speciální barvy, Chrom a barvy Premium	23	WRMASIM002 K...
84mm hranatá 30x30	Barvy RAL, Speciální barvy, Chrom a barvy Premium	23	WRMASIM003 K...
120mm kulatá	Barvy RAL, Speciální barvy, Chrom a barvy Premium	25	WRMASIM004 K...
120mm hranatá 30x30	Barvy RAL, Speciální barvy, Chrom a barvy Premium	25	WRMASIM005 K...

Delší krytky 120mm jsou potřeba pouze pro radiátory: TRIGA AN E a TUNE VWD a VWD E

Terma Split třída I

Topný element TS1 a Regulátory řady KTX tvoří kompletní topné tyče KTX4 Blue, KTX 4, KTX 3, KTX 2, KTX 1.



Název	Výkon [W]	Cena bez DPH [EUR]	Kód produktu
Terma Split třída I	120	33	WETS101 K---D
Terma Split třída I	200	33	WETS102 K---D
Terma Split třída I	300	33	WETS103 K---D
Terma Split třída I	400	33	WETS104 K---D
Terma Split třída I	600	33	WETS106 K---D
Terma Split třída I	800	33	WETS108 K---D
Terma Split třída I	1000	33	WETS110 K---D

Bojlerová topná tyč TNK



Název	Výkon [W]	Velikost závitů	Cena bez DPH [EUR]	Kód produktu
Bojlerová topná tyč TNK	2000	G 1 1/4	96	TGBTNK 54 20 W1
Bojlerová topná tyč TNK	3000	G 1 1/4	108	TGBTNK 54 30 W1
Bojlerová topná tyč TNK	2000	G 1 1/2	101	TGBTNK 64 20 W1
Bojlerová topná tyč TNK	3000	G 1 1/2	114	TGBTNK 64 30 W1

TTIR1 – Termostat s týdenním programem



Ovládá bezdrátově topné tyče KTX4, MOA IR, ONE.

Rozlišuje pracovní dny a víkend + další režimy.

Montáž na stěnu nebo volně stojící na polici.



Napájení bateriemi	Komunikační modul	Stupeň krytí IP	Barva	Cena bez DPH [EUR]	Kód produktu
2 x LR03 (AAA)	IR	IP 30	Bílá	104	TGRTBI001

DTIR1 – Termostat s denním programem



Ovládá bezdrátově topné tyče KTX4, MOA IR, ONE.

Nerozlišuje pracovní dny a víkend. Nastavíte program a ten potom spíná každý den stejně.



Napájení bateriemi	Komunikační modul	Stupeň krytí IP	Barva	Cena bez DPH [EUR]	Kód produktu
2 x LR03 (AAA)	IR	IP 30	Bílá	77	TGRDBI001
2 x LR03 (AAA)	IR	IP 30	Stříbrná	78	TGRDSI001

Police a věšáky

Police EASY

DOSTUPNÝ MATERIÁL:

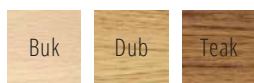

URČENÁ PRO RADIÁTORY:

Easy

Velikost [mm] (šíře radiátoru)	B [mm] (šíře produktu)	Materiál	Cena bez DPH [EUR]	Kód produktu a konfigurace
200	180	Buk	41	WRPEAS020 KBUK
200	180	Dub	43	WRPEAS020 KDAB
200	180	Teak	74	WRPEAS020 KTEK

Police SIMPLE

DOSTUPNÝ MATERIÁL:

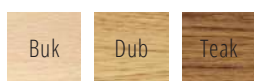

URČENÁ PRO RADIÁTORY:

Simple

Velikost [mm] (šíře radiátoru)	B [mm] (šíře produktu)	Materiál	Cena bez DPH [EUR]	Kód produktu a konfigurace
500	440	Buk	50	WRPSIM050 KBUK
500	440	Dub	56	WRPSIM050 KDAB
500	440	Teak	118	WRPSIM050 KTEK

Police STAND

DOSTUPNÝ MATERIÁL:

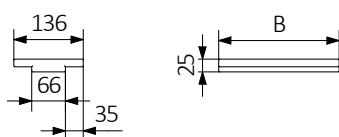
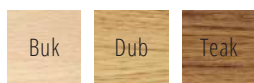

URČENÁ PRO RADIÁTORY:

Stand

Velikost [mm] (šířě radiátoru)	B [mm] (šířě produktu)	Materiál	Cena bez DPH [EUR]	Kód produktu a konfigurace
300	236	Buk	43	WRPSCA030 KBUK
300	236	Dub	58	WRPSCA030 KDAB
300	236	Teak	126	WRPSCA030 KTEK
400	336	Buk	45	WRPSCA040 KBUK
400	336	Dub	62	WRPSCA040 KDAB
400	336	Teak	144	WRPSCA040 KTEK
500	436	Buk	48	WRPSCA050 KBUK
500	436	Dub	65	WRPSCA050 KDAB
500	436	Teak	176	WRPSCA050 KTEK

Police BOOKIE

DOSTUPNÝ MATERIÁL:

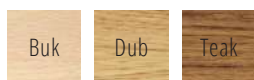

URČENÁ PRO RADIÁTORY:

Bookie

B [mm] (šířě produktu)	Materiál	Cena bez DPH [EUR]	Kód produktu a konfigurace
300	Buk	40	WRPBUK030 KBUK
300	Dub	54	WRPBUK030 KDAB
300	Teak	116	WRPBUK030 KTEK
400	Buk	42	WRPBUK040 KBUK
400	Dub	58	WRPBUK040 KDAB
400	Teak	134	WRPBUK040 KTEK
500	Buk	45	WRPBUK050 KBUK
500	Dub	61	WRPBUK050 KDAB
500	Teak	166	WRPBUK050 KTEK

Police TRIGA

DOSTUPNÝ MATERIÁL:

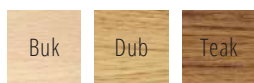

MONTÁŽNÍ MADLA:



URČENÁ PRO RADIÁTORY:

Triga

Velikost [mm] (šíře radiátoru)	B [mm] (šíře produktu)	Materiál	Cena bez DPH [EUR]	Kód produktu a konfigurace
380	410	Buk	78	WRPTRG038 KBUK
380	410	Dub	79	WRPTRG038 KDAB
380	410	Teak	133	WRPTRG038 KTEK
480	510	Buk	81	WRPTRG048 KBUK
480	510	Dub	82	WRPTRG048 KDAB
480	510	Teak	158	WRPTRG048 KTEK
580	610	Buk	84	WRPTRG058 KBUK
580	610	Dub	86	WRPTRG058 KDAB
580	610	Teak	174	WRPTRG058 KTEK
680	710	Buk	87	WRPTRG068 KBUK
680	710	Dub	90	WRPTRG068 KDAB
680	710	Teak	188	WRPTRG068 KTEK

Police s držákem TRIGA

DOSTUPNÝ MATERIÁL:

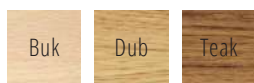

MONTÁŽNÍ MADLA:



URČENÁ PRO RADIÁTORY:

Triga

Velikost [mm] (šířka radiátoru)	B [mm] (šířka produktu)	Materiál	Cena bez DPH [EUR]	Kód produktu a konfigurace
380	410	Buk	82	WRQTRG038 KBUK
380	410	Dub	84	WRQTRG038 KDAB
380	410	Teak	147	WRQTRG038 KTEK
480	510	Buk	84	WRQTRG048 KBUK
480	510	Dub	86	WRQTRG048 KDAB
480	510	Teak	167	WRQTRG048 KTEK
580	610	Buk	86	WRQTRG058 KBUK
580	610	Dub	88	WRQTRG058 KDAB
580	610	Teak	188	WRQTRG058 KTEK
680	710	Buk	89	WRQTRG068 KBUK
680	710	Dub	93	WRQTRG068 KDAB
680	710	Teak	208	WRQTRG068 KTEK

Držák TRIGA

DOSTUPNÝ MATERIÁL:

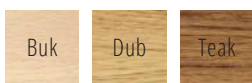

MONTÁŽNÍ MADLA:



URČEN PRO RADIÁTORY:

Triga

Velikost [mm] (šířka radiátoru)	B [mm] (šířka produktu)	Materiál	Cena bez DPH [EUR]	Kód produktu a konfigurace
380	410	Buk	78	WRRTRG038 KBUK
380	410	Dub	78	WRRTRG038 KDAB
380	410	Teak	132	WRRTRG038 KTEK
480	510	Buk	80	WRRTRG048 KBUK
480	510	Dub	82	WRRTRG048 KDAB
480	510	Teak	157	WRRTRG048 KTEK
580	610	Buk	84	WRRTRG058 KBUK
580	610	Dub	86	WRRTRG058 KDAB
580	610	Teak	173	WRRTRG058 KTEK
680	710	Buk	86	WRRTRG068 KBUK
680	710	Dub	89	WRRTRG068 KDAB
680	710	Teak	186	WRRTRG068 KTEK

Držák BELT

MOŽNOSTI BAREVNÝCH ÚPRAV:

vzorník RAL, Speciálních barev, barev Premium a Chrom



Určen pro radiátory Triga



Velikost [mm] (šířka radiátoru)	B [mm]	Barvy RAL a speciální barvy Cena bez DPH [EUR]	Chrom a barvy Premium Cena bez DPH [EUR]	Kód produktu ... Kód konfigurace s. 390
380	388	35	40	WRRRGT038...
480	488	37	43	WRRRGT048...
580	588	39	46	WRRRGT058...
680	688	41	49	WRRRGT068...
780	788	43	52	WRRRGT078...
880	888	45	55	WRRRGT088...

Háček bodový HANDY GRIP

MOŽNOSTI BAREVNÝCH ÚPRAV:



URČEN PRO RADIÁTORY:

Určen pro trubkové radiátory s kulatými profily.
Sada obsahuje dva háčky.

Barva	Cena bez DPH [EUR]	Kód produktu
Bílá	21	TGWBI010
Chrom	23	TGWCR008
Černá Mat	22	TGWCZ003

Háček bodový HANDY VIP

MOŽNOSTI BAREVNÝCH ÚPRAV:



URČEN PRO RADIÁTORY:

Určen pro trubkové radiátory s kulatými profily.
Sada obsahuje dva háčky.

Barva	Cena bez DPH [EUR]	Kód produktu
Bílá	21	TGWBI005
Chrom	23	TGWCR005
Černá Mat	22	TGWCZ001

Háček bodový KUKA

MOŽNOSTI BAREVNÝCH ÚPRAV (CHROM A NOVINKA V BARVÁCH PREMIUM):



URČEN PRO RADIÁTORY:

Kuka 50 – Sherwood, Vivo

Kuka 70 – Cyklon

Velikost	Barva	Cena bez DPH [EUR]	Kód produktu <small>... Kód konfigurace s. 390</small>
50 x 10 mm	Chrom a barvy Premium	44	WRWKUK001...
70 x 11 mm	Chrom a barvy Premium	44	WRWKUK002...

Háček bodový SPARK

MOŽNOSTI BAREVNÝCH ÚPRAV (CHROM A NOVINKA V BARVÁCH PREMIUM):

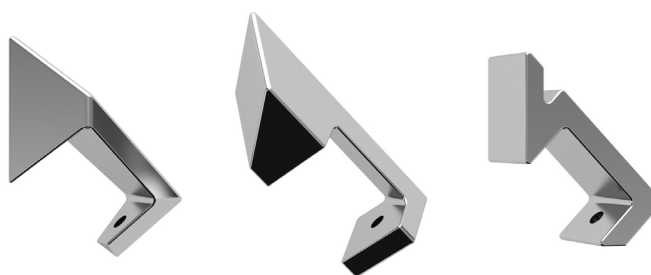

Spark 1

Spark 2

Spark 3

URČEN PRO RADIÁTORY:

Diamond

Verze	Velikost	Barva	Cena bez DPH [EUR]	Kód produktu <small>... Kód konfigurace s. 390</small>
SPARK 1	25 mm	Chrom a barvy Premium	46	WRWSP1025...
SPARK 2	25 mm	Chrom a barvy Premium	46	WRWSP2025...
SPARK 3	25 mm	Chrom a barvy Premium	46	WRWSP3025...

Háček bodový Yo!

URČEN PRO RADIÁTORY:

Aero H, Aero HG, Alex, Alex One, Domi, Fiona, Fiona One, Iron D, Iron S, Lena, Lima, Lima One, POC 2, Pola, Pola One, Tytus, Tytus One



Barva	Cena bez DPH [EUR]	Kód produktu
hnědá	4	WRWYOY001 SBRZ
červená	4	WRWYOY001 SCZE
zelená	4	WRWYOY001 SZIE
žlutá	4	WRWYOY001 SZOL
šedá	4	WRWYOY001 SSZA
modrá	4	WRWYOY001 SNIE
bílá	4	WRWJPU001 SBIA
černá	4	WRWYOY001 SCZA

Háček bodový ZIP H

MOŽNOSTI BAREVNÝCH ÚPRAV:

Chrom a **NOVINKA** v barvách Premium + Černá Polomat 9M5 a Mat S95 + Bílá Polomat J16 a Mat S96



URČEN PRO RADIÁTORY:

Zip H 10 – Dexter, Dexter Pro, City, Iron D, Iron S, Kioto, Lukka, Marlin, Mantis, Incorner, Outcorner, Quadrus Slim, Quadrus Bold, Warp S, Warp T, Warp T Bold, Vivo

Zip H 20 – Bone

Velikost	Barva	Cena bez DPH [EUR]	Kód produktu <small>... Kód konfigurace s. 390</small>
10 mm	Chrom a barvy Premium + Černá a Bílá Polomat a Mat	42	WRWZIP008...
20 mm	Chrom a barvy Premium + Černá a Bílá Polomat a Mat	42	WRWZIP010...

Háček bodový ZIP V

MOŽNOSTI BAREVNÝCH ÚPRAV:

Chrom a **NOVINKA** v barvách Premium + Černá Polomat 9M5 a Mat S95 + Bílá Polomat J16 a Mat S96



Chrom

URČEN PRO RADIÁTORY:

Zip V 10 – Nemo

Zip V 20 – Intra, Intra M

Zip V 30 – Angus, Easy, Grid, Triga (AW, AN), Sherwood, Simple, Step, ZigZag

Zip V 40 – Triga

Velikost	Barva	Cena bez DPH [EUR]	Kód produktu <small>... Kód konfigurace s. 390</small>
10 mm	Chrom a barvy Premium + Černá a Bílá Polomat a Mat	42	WRWZIP009 ...
20 mm	Chrom a barvy Premium + Černá a Bílá Polomat a Mat	42	WRWZIP011 ...
30 mm	Chrom a barvy Premium + Černá a Bílá Polomat a Mat	44	WRWZIP012 ...
40 mm	Chrom a barvy Premium + Černá a Bílá Polomat a Mat	44	WRWZIP013 ...

Držák vyhnutý BASIC

MOŽNOSTI BAREVNÝCH ÚPRAV:

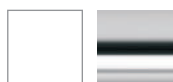

Držák na ručníky vhodný pro radiátory s prohnutými trubkami.

Dodává se ve dvou velikostech pro šířky radiátorů větší než 450 mm a 550 mm.

URČEN PRO RADIÁTORY:

Určeno pro radiátory s kulatými vyhnutými příčkami (LENA, DOMI, DEXTER)

Velikost	Barva	Cena bez DPH [EUR]	Kód produktu
Ø 16/L340 mm	Bílá	28	TGWBI004
Ø 16/L340 mm	Chrom	32	TGWCR004
Ø 16/L430 mm	Bílá	28	TGWBI002
Ø 16/L430 mm	Chrom	32	TGWCR002

Držák BASIC

MOŽNOSTI BAREVNÝCH ÚPRAV:



Držák na ručníky vhodný pro radiátory s přímou trubicí.
Dodává se ve dvou velikostech pro šířky radiátorů větší než 450 mm a 550 mm.

URČEN PRO RADIÁTORY:

Určeno pro radiátory s kulatými rovnými příčkami (FIONA, MIKE)

Velikost	Barva	Cena bez DPH [EUR]	Kód produktu
Ø 16/L370 mm	Bílá	28	TGWBI003
Ø 16/L370 mm	Chrom	32	TGWCR003
Ø 16/L460 mm	Bílá	28	TGWBI001
Ø 16/L460 mm	Chrom	32	TGWCR001

Háček bodový HAPPY HIPPO

MOŽNOSTI BAREVNÝCH ÚPRAV:

vzorník RAL, Speciálních barev, barev Premium, bez Chromu

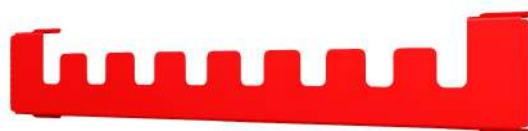

URČEN PRO RADIÁTORY:

Vivo

Velikost	Barva	Cena bez DPH [EUR] u barev Premium +25%	Kód produktu ...Kód konfigurace s. 390
300 mm	Barvy RAL, Speciální barvy a barvy Premium	21	WRWH1C024...
400 mm	Barvy RAL, Speciální barvy a barvy Premium	21	WRWH1C034 ...
500 mm	Barvy RAL, Speciální barvy a barvy Premium	21	WRWH1C044 ...
600 mm	Barvy RAL, Speciální barvy a barvy Premium	21	WRWH1C054 ...

Háček bodový HAPPY RABBIT

MOŽNOSTI BAREVNÝCH ÚPRAV:

vzorník RAL, Speciálních barev, barev Premium, bez Chromu



URČEN PRO RADIÁTORY

Vivo

Velikost	Barva	Cena bez DPH [EUR] u barev Premium +25%	Kód produktu ...Kód konfigurace s. 390
300 mm	Barvy RAL, Speciální barvy a barvy Premium	21	WRWH1B024 ...
400 mm	Barvy RAL, Speciální barvy a barvy Premium	21	WRWH1B034 ...
500 mm	Barvy RAL, Speciální barvy a barvy Premium	21	WRWH1B044 ...
600 mm	Barvy RAL, Speciální barvy a barvy Premium	21	WRWH1B054 ...

Háček bodový HAPPY SHARK

MOŽNOSTI BAREVNÝCH ÚPRAV:

vzorník RAL, Speciálních barev, barev Premium, bez Chromu



URČEN PRO RADIÁTORY:

Vivo

Velikost	Barva	Cena bez DPH [EUR] u barev Premium +25%	Kód produktu ...Kód konfigurace s. 390
300 mm	Barvy RAL, Speciální barvy a barvy Premium	21	WRWH1A024 ...
400 mm	Barvy RAL, Speciální barvy a barvy Premium	21	WRWH1A034 ...
500 mm	Barvy RAL, Speciální barvy a barvy Premium	21	WRWH1A044 ...
600 mm	Barvy RAL, Speciální barvy a barvy Premium	21	WRWH1A054 ...

Háček bodový SIMPLE

MOŽNOSTI BAREVNÝCH ÚPRAV:

vzorník RAL, Speciálních barev, barev Premium, bez Chromu



URČEN PRO RADIÁTORY:

Simple

Velikost	Barva	Cena bez DPH [EUR] u barev Premium +25%	Kód produktu ... Kód konfigurace s. 390
500 mm	Barvy RAL, Speciální barvy a barvy Premium	21	WRWSIM004 ...

Držák CASE SLIM

MOŽNOSTI BAREVNÝCH ÚPRAV:

vzorník RAL, Speciálních barev, barev Premium, Chrom



URČEN PRO RADIÁTORY:

Case Slim

Velikost [mm] (šíře radiátoru)	B [mm] (šíře produktu)	Barva	Cena bez DPH [EUR] u barev Premium +25%	Kód produktu ... Kód konfigurace s. 390
420 mm	448 mm	Barvy RAL, Speciální barvy a barvy Premium	37	WRRCSS042 ...
520 mm	548 mm	Barvy RAL, Speciální barvy a barvy Premium	37	WRRCSS052 ...
620 mm	648 mm	Barvy RAL, Speciální barvy a barvy Premium	38	WRRCSS062 ...
420 mm	448 mm	Chrom	45	WRRCSS042 ...
520 mm	548 mm	Chrom	46	WRRCSS052 ...
620 mm	648 mm	Chrom	49	WRRCSS062 ...

Stoupačkový profil k radiátoru Michelle

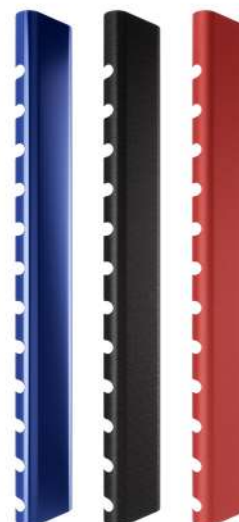

MOŽNOSTI BAREVNÝCH ÚPRAV:

vzorník RAL, Speciálních barev, barev Premium, Chrom

URČEN PRO RADIÁTORY:

Michelle

Velikost A ∇ [mm]	Orientace [pro připojení YL Levá, pro YP Pravá]	Barva Cena bez DPH [EUR] u barev Premium +25%	Chrom Cena bez DPH [EUR]	Kód produktu ...Kód konfigurace s. 390
780 mm	Levá	59	115	WRCMIC078L...
780 mm	Pravá	59	115	WRCMIC078P...
1200 mm	Levá	68	153	WRCMIC120L...
1200 mm	Pravá	68	153	WRCMIC120P...
1620 mm	Levá	77	192	WRCMIC162L...
1620 mm	Pravá	77	192	WRCMIC162P...

Stoupačkový profil k radiátoru Iron D a Iron S

MOŽNOSTI BAREVNÝCH ÚPRAV:

vzorník RAL, Speciálních barev, barev Premium

URČEN PRO RADIÁTORY:

Iron D i Iron S stejná velikost pro
šíře radiátorů 400, 500 i 600mm.

Velikost A ∇ [mm]	Cena bez DPH [EUR] u barev Premium +25%	Kód produktu ...Kód konfigurace s. 390
730 mm	78	WRCIRX073...
925 mm	85	WRCIRX092...
1120 mm	93	WRCIRX112...
1315 mm	100	WRCIRX131...
1510 mm	107	WRCIRX151...
1705 mm	114	WRCIRX170...

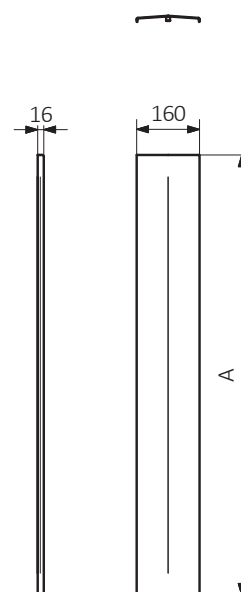

Sady ventilů

Sada Dexter regulační

DOSTUPNÉ VERZE:



Levá

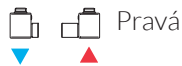

Pravá

MOŽNOSTI BAREVNÝCH ÚPRAV:



PŘIPOJENÍ:



URČENÁ PRO RADIÁTORY:

Dexter

DOPORUČUJEME: SADA KRYCÍ DVOJITÁ



TGPCR001: 27EUR

Stránka: 373



Orientace	Velikost	Barva	Cena bez DPH [EUR]	Kód produktu
Levá	GZ 1/2" – Ø16x2, Ø15	Bílá	129	TGERCD2-BI
Pravá	GZ 1/2" – Ø16x2, Ø15	Bílá	129	TGERCD1-BI
Levá	GZ 1/2" – Ø16x2, Ø15	Chrom	131	TGERCD1-CR
Pravá	GZ 1/2" – Ø16x2, Ø15	Chrom	131	TGERCD2-CR
Levá	GZ 1/2" – Ø16x2, Ø15	Satén	174	TGERCD1-ST
Pravá	GZ 1/2" – Ø16x2, Ø15	Satén	174	TGERCD2-ST

Sada termostatická Dexter

DOSTUPNÉ VERZE:



Levá

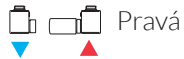

Pravá

MOŽNOSTI BAREVNÝCH ÚPRAV:



PŘIPOJENÍ:



URČENÁ PRO RADIÁTORY:

Dexter

DOPORUČUJEME: SADA KRYCÍ DVOJITÁ



TGPCR001: 27EUR

Stránka: 373



Orientace	Velikost	Barva	Cena bez DPH [EUR]	Kód produktu
Levá	GZ 1/2" – Ø16x2, Ø15	Bílá	170	TGETCG1-BI
Pravá	GZ 1/2" – Ø16x2, Ø15	Bílá	170	TGETCG2-BI
Levá	GZ 1/2" – Ø16x2, Ø15	Chrom	174	TGETCG6-CR
Pravá	GZ 1/2" – Ø16x2, Ø15	Chrom	174	TGETCG7-CR
Levá	GZ 1/2" – Ø16x2, Ø15	Satén	223	TGETCG1-ST
Pravá	GZ 1/2" – Ø16x2, Ø15	Satén	223	TGETCG2-ST

Sada rohová regulační „Wood”

MOŽNOSTI BAREVNÝCH ÚPRAV:



PŘIPOJENÍ:

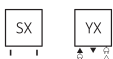

URČENÁ PRO RADIÁTORY:

Pajak



Velikost	Barva	Cena bez DPH [EUR]	Kód produktu
GZ 1/2" – Ø16x2, Ø15	Měď kartáčovaná	209	TGERME001

Sada regulační rohová

MOŽNOSTI BAREVNÝCH ÚPRAV:



PŘIPOJENÍ:

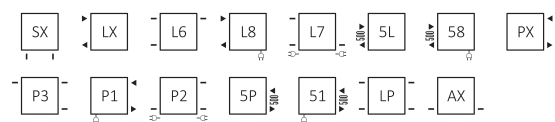

DOPORUČUJEME: SADA KRYCÍ DVOJITÁ



TGPCR001: 27EUR
Stránka: 373

Velikost	Barva	Cena bez DPH [EUR]	Kód produktu
GZ 1/2" - Ø16x2, Ø15	Chrom	99	WRZRCK1-CR

Sada regulační rohová Star

MOŽNOSTI BAREVNÝCH ÚPRAV:



PŘIPOJENÍ:

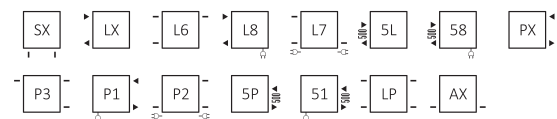

DOPORUČUJEME: SADA KRYCÍ DVOJITÁ



TGPCR001: 27EUR

Stránka: 373



Velikost	Barva	Cena bez DPH [EUR]	Kód produktu
GZ 1/2" - Ø16x2, Ø15	Chrom	148	TGERSTCR01

Sada rohová termostatická

MOŽNOSTI BAREVNÝCH ÚPRAV:



PŘIPOJENÍ:

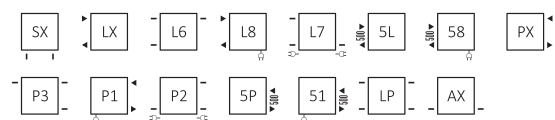

DOPORUČUJEME: SADA KRYCÍ DVOJITÁ



TGPCR001:27EUR

Stránka: 373



Velikost	Barva	Cena bez DPH [EUR]	Kód produktu
GZ 1/2" - Ø16x2, Ø15	Chrom	134	WRZTCG3-CR

Sada tříosová regulační

DOSTUPNÉ VERZE:



MOŽNOSTI BAREVNÝCH ÚPRAV:



PŘIPOJENÍ:



DOPORUČUJEME: SADA KRYCÍ DVOJITÁ



TGPCR001: 27EUR

Stránka: 373

Orientace	Velikost	Barva	Cena bez DPH [EUR]	Kód produktu
Levá	GZ 1/2" – Ø16x2, Ø15	Chrom	99	WRZRC31-CR
Pravá	GZ 1/2" – Ø16x2, Ø15	Chrom	99	WRZRC32-CR

Sada tříosová termostatická

DOSTUPNÉ VERZE:

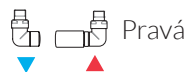

MOŽNOSTI BAREVNÝCH ÚPRAV:



PŘIPOJENÍ:



DOPORUČUJEME: SADA KRYCÍ DVOJITÁ



TGPCR001: 27EUR
Stránka: 373

Orientace	Velikost	Barva	Cena bez DPH [EUR]	Kód produktu
Levá	GZ 1/2" – Ø16x2, Ø15	Chrom	143	WRZTCG1-CR
Pravá	GZ 1/2" – Ø16x2, Ø15	Chrom	143	WRZTCG2-CR

Sada tříosová termostatická s možností montáže topné tyče skrz ventil

DOSTUPNÉ VERZE:



Levá



Pravá

MOŽNOSTI BAREVNÝCH ÚPRAV:



PŘIPOJENÍ:



DOPORUČUJEME: SADA KRYCÍ DVOJITÁ



TGPCR001: 27 EUR

Stránka: 373

Orientace	Velikost	Barva	Cena bez DPH [EUR]	Kód produktu
Levá	GZ 1/2" – Ø16x2, Ø15	Chrom	147	WRZTCG4-CR
Pravá	GZ 1/2" – Ø16x2, Ø15	Chrom	147	WRZTCG5-CR

Integrovaná sada termostatická

DOSTUPNÉ VERZE:

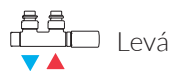

MOŽNOSTI BAREVNÝCH ÚPRAV:



PŘIPOJENÍ:

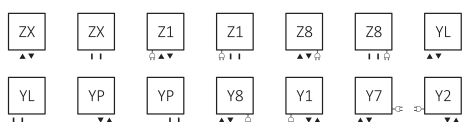

DOPORUČUJEME: SADA KRYCÍ INTEGROVANÁ, CHROM



TGPCR002: 38EUR

Stránka: 374

Orientace	Velikost	Barva	Cena bez DPH [EUR]	Kód produktu
Ventil rohový – 90°				
Levá	GZ 1/2" – Ø16x2, Ø15	Chrom	145	WRZT5G1-CR
Pravá	GZ 1/2" – Ø16x2, Ø15	Chrom	145	WRZT5G2-CR
Ventil přímý				
Levá	GZ 1/2" – Ø16x2, Ø15	Chrom	146	WRZT5G3-CR
Pravá	GZ 1/2" – Ø16x2, Ø15	Chrom	146	WRZT5G4-CR

Sada komplexní integrovaný ventil s T- kusem s možností připojení topné tyče skrze ventil

DOSTUPNÉ VERZE (TOPNÁ TYČ SE MONTUJE NA VÝSTUPU):

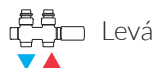

MOŽNOSTI BAREVNÝCH ÚPRAV:



URČENÁ PRO RADIÁTORY:

Michelle, Warp S, Iron D, Iron S



DOPORUČUJEME: SADA KRYCÍ INTEGROVANÁ, CHROM



TGPCR002: 38 EUR
Stránka: 374

Orientace	Velikost	Barva	Cena bez DPH [EUR]	Kód produktu
Levá	GZ 1/2" – Ø16x2, Ø15	Chrom	188	WRZT5G14-CR
Pravá	GZ 1/2" – Ø16x2, Ø15	Chrom	188	WRZT5G15-CR

Integrovaná sada termostatická s ponornou trubicí

DOSTUPNÉ VERZE:



Levá



Pravá

MOŽNOSTI BAREVNÝCH ÚPRAV:



PŘIPOJENÍ:



DOPORUČUJEME: SADA KRYCÍ INTEGROVANÁ, CHROM



TGPCR002:38EUR
Stránka: 374

Orientace	Velikost	Barva	Cena bez DPH [EUR]	Kód produktu
Ventil rohový – 90°				
Levá	GZ 1/2" – Ø16x2, Ø15	Chrom	151	WRZT5G5-CR
Pravá	GZ 1/2" – Ø16x2, Ø15	Chrom	151	WRZT5G6-CR
Ventil přímý				
—	GZ 1/2" – Ø16x2, Ø15	Chrom	151	WRZT5G7-CR

Integrovaná sada uzavírací

MOŽNOSTI BAREVNÝCH ÚPRAV:



PŘIPOJENÍ:



DOPORUČUJEME: SADA KRYCÍ INTEGROVANÁ, CHROM



TGPCR002: 38EUR
Stránka: 374

Velikost	Barva	Cena bez DPH [EUR]	Kód produktu
Ventil rohový – 90°			
GZ 1/2" – Ø16x2, Ø15	Chrom	116	WRZOSSC1-CR
Ventil přímý			
GW 3/4" (GZ 1/2") – Ø16x2, Ø15	Chrom	116	WRZOSSC2-CR

Integrovaná sada termostatická TWINS ALL IN ONE

MOŽNOSTI BAREVNÝCH ÚPRAV:

Ve všech Barvách RAL, barvách Premium a speciálních barvách*.

PŘIPOJENÍ:

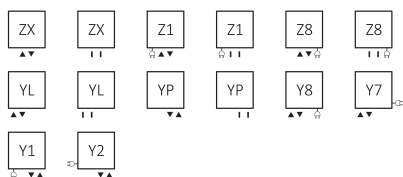

DOSTUPNÉ VERZE:



SADA OBSAHUJE:

Komplexní integrovaný termostatický ventil
2 × Adaptér PEX, ALU-PEX 16×2

Termostatická hlavice M30 × 1.5
2 × Adaptér CU Ø 15
Sada krycí

Skladem v barvách: Chrom, Černá, Černá Polomat, Bílá Mat, Bílá

Orientace	Barva	Cena bez DPH u barev Premium +25% do barev RAL [EUR]	Kód produktu	Kód konfigurace
Pravá	Chrom	124	TGETTWINP	KCRO
Levá	Chrom	124	TGETTWINL	KCRO
Pravá	Černá	131	TGETTWINP	K9P5
Levá	Černá	131	TGETTWINL	K9P5
Pravá	Černá Polomat	131	TGETTWINP	K9M5
Levá	Černá Polomat	131	TGETTWINL	K9M5
Pravá	Bílá Mat	131	TGETTWINP	KS96
Levá	Bílá Mat	131	TGETTWINL	KS96
Pravá	Bílá	124	TGETTWINP	K916
Levá	Bílá	124	TGETTWINL	K916
Pravá	Barvy RAL a speciální barvy*	159	TGETTWINP	K... Kód konfigurace s. 388
Levá	Barvy RAL a speciální barvy*	159	TGETTWINL	K... Kód konfigurace s. 388

* nelze: Black Crocodile New, White Gold, SOFT ani MATT od všech RAL(pouze SOFT 9005, SOFT 9016, SOFT 7047, MATT 7016 a MATT 9016 jde)

Integrovaná sada termostatická s ponor- nou trubicí UNICO ALL IN ONE

MOŽNOSTI BAREVNÝCH ÚPRAV:

Ve všech Barvách RAL, barvách Premium a speciálních barvách*.

PŘIPOJENÍ:



DOSTUPNÉ VERZE:



SADA OBSAHUJE:

Komplexní integrovaný termostatický ventil s ponornou trubicí
2 x Adaptér PEX, ALU-PEX 16x2

Termostatická hlavice M30 x 1.5
2 x Adaptér CU Ø 15
Sada krycí

Skladem v barvách: Chrom, Černá, Černá Polomat, Bílá Mat, Bílá

Orientace	Barva	Cena bez DPH u barev Premium +25% do barev RAL [EUR]	Kód produktu	Kód konfigurace
Pravá	Chrom	128	TGETUNICP	KCRO
Levá	Chrom	128	TGETUNICL	KCRO
Pravá	Černá	133	TGETUNICP	K9P5
Levá	Černá	133	TGETUNICL	K9P5
Pravá	Černá Polomat	133	TGETUNICP	K9M5
Levá	Černá Polomat	133	TGETUNICL	K9M5
Pravá	Bílá Mat	133	TGETUNICP	KS96
Levá	Bílá Mat	133	TGETUNICL	KS96
Pravá	Bílá	128	TGETUNICP	K916
Levá	Bílá	128	TGETUNICL	K916
Pravá	Barvy RAL a speciální barvy*	162	TGETUNICP	K... Kód konfigurace s. 388
Levá	Barvy RAL a speciální barvy*	162	TGETUNICL	K... Kód konfigurace s. 388

* nelze: Black Crocodile New, White Gold, SOFT ani MATT od všech RAL(pouze SOFT 9005, SOFT 9016, SOFT 7047, MATT 7016 a MATT 9016 jde)

Sada tříosová termostatická INTEGRA ALL IN ONE s možností montáže topné tyče skrz ventil

MOŽNOSTI BAREVNÝCH ÚPRAV:

Ve všech Barvách RAL, barvách Premium a speciálních barvách*.

PŘIPOJENÍ:



DOSTUPNÉ VERZE:



SADA OBSAHUJE:

Ventil tříosý termostatický
Ventil tříosý uzavírací s možností montáže topné tyče skrz ventil
Termostatická hlavice M30 x 1.5

Sada krycí
2 x Adaptér PEX, ALU-PEX 16x2
2 x Adaptér CU Ø 15

Skladem v barvách: Chrom, Černá, Černá Polomat, Bílá Mat, Bílá

Orientace	Barva	Cena bez DPH u barev Premium +25% do barev RAL [EUR]	Kód produktu	Kód konfigurace
Pravá	Chrom	126	TGETINTEP	KCRO
Levá	Chrom	126	TGETINTEL	KCRO
Pravá	Černá	133	TGETINTEP	K9P5
Levá	Černá	133	TGETINTEL	K9P5
Pravá	Černá Polomat	133	TGETINTEP	K9M5
Levá	Černá Polomat	133	TGETINTEL	K9M5
Pravá	Bílá Mat	133	TGETINTEP	KS96
Levá	Bílá Mat	133	TGETINTEL	KS96
Pravá	Bílá	126	TGETINTEP	K916
Levá	Bílá	126	TGETINTEL	K916
Pravá	Barvy RAL a speciální barvy*	161	TGETINTEP	K... Kód konfigurace s. 388
Levá	Barvy RAL a speciální barvy*	161	TGETINTEL	K... Kód konfigurace s. 388

* nelze: Black Crocodile New, White Gold, SOFT ani MATT od všech RAL(pouze SOFT 9005, SOFT 9016, SOFT 7047, MATT 7016 a MATT 9016 jde)

Sada třísová termostatická VISION ALL IN ONE

MOŽNOSTI BAREVNÝCH ÚPRAV:

Ve všech Barvách RAL, barvách Premium a speciálních barvách*.

PŘIPOJENÍ:



DOSTUPNÉ VERZE:



SADA OBSAHUJE:

Ventil třísový termostatický
Ventil třísový uzavírací
Termostatická hlavice M30 x 1.5

Sada krycí
2 x Adaptér PEX, ALU-PEX 16x2
2 x Adaptér CU Ø 15

Skladem v barvách: Chrom, Černá, Černá Polomat, Bílá Mat, Bílá

Orientace	Barva	Cena bez DPH u barev Premium +25% do barev RAL [EUR]	Kód produktu	Kód konfigurace
Pravá	Chrom	102	TGETVISIP	KCRO
Levá	Chrom	102	TGETVISIL	KCRO
Pravá	Černá	109	TGETVISIP	K9P5
Levá	Černá	109	TGETVISIL	K9P5
Pravá	Černá Polomat	109	TGETVISIP	K9M5
Levá	Černá Polomat	109	TGETVISIL	K9M5
Pravá	Bílá Mat	109	TGETVISIP	KS96
Levá	Bílá Mat	109	TGETVISIL	KS96
Pravá	Bílá	102	TGETVISIP	K916
Levá	Bílá	102	TGETVISIL	K916
Pravá	Barvy RAL a speciální barvy*	137	TGETVISIP	K... Kód konfigurace s. 388
Levá	Barvy RAL a speciální barvy*	137	TGETVISIL	K... Kód konfigurace s. 388

* nelze: Black Crocodile New, White Gold, SOFT ani MATT od všech RAL(pouze SOFT 9005, SOFT 9016, SOFT 7047, MATT 7016 a MATT 9016 jde)

Sada tříosová regulační VISION ALL IN ONE

MOŽNOSTI BAREVNÝCH ÚPRAV:

Ve všech Barvách RAL, barvách Premium a speciálních barvách*.

PŘIPOJENÍ:



DOSTUPNÉ VERZE:



SADA OBSAHUJE:

Ventil tříosý regulační
Ventil tříosý uzavírací
Sada krycí

2 × Adaptér PEX, ALU-PEX 16×2
2 × Adaptér CU Ø 15

Skladem v barvách: Chrom, Černá, Černá Polomat, Bílá Mat, Bílá

Orientace	Barva	Cena bez DPH u barev Premium +25% do barev RAL [EUR]	Kód produktu	Kód konfigurace
Pravá	Chrom	83	TGERVISIP	KCRO
Levá	Chrom	83	TGERVISIL	KCRO
Pravá	Černá	90	TGERVISIP	K9P5
Levá	Černá	90	TGERVISIL	K9P5
Pravá	Černá Polomat	90	TGERVISIP	K9M5
Levá	Černá Polomat	90	TGERVISIL	K9M5
Pravá	Bílá Mat	90	TGERVISIP	KS96
Levá	Bílá Mat	90	TGERVISIL	KS96
Pravá	Bílá	83	TGERVISIP	K916
Levá	Bílá	83	TGERVISIL	K916
Pravá	Barvy RAL a speciální barvy*	118	TGERVISIP	K... Kód konfigurace s. 388
Levá	Barvy RAL a speciální barvy*	118	TGERVISIL	K... Kód konfigurace s. 388

* nelze: Black Crocodile New, White Gold, SOFT ani MATT od všech RAL(pouze SOFT 9005, SOFT 9016, SOFT 7047, MATT 7016 a MATT 9016 jde)

Integrovaná sada uzavírací PREMIUM rohová ALL IN ONE

MOŽNOSTI BAREVNÝCH ÚPRAV:

Ve všech Barvách RAL, barvách Premium a speciálních barvách*.

PŘIPOJENÍ:



DOSTUPNÉ VERZE:

SADA OBSAHUJE:

Ventil integrovaný uzavírací (VK)
2 × Adaptér PEX, ALU-PEX 16×2
Termostatická hlavice M30 × 1.5

2 × Adaptér CU Ø 15
Sada krycí

Skladem v barvách: Chrom, Černá, Černá Polomat, Bílá Mat, Bílá

Barva	Cena bez DPH u barev Premium +25% do barev RAL [EUR]	Kód produktu	Kód konfigurace
Chrom	102	TGETPREMK	KCRO
Černá	109	TGETPREMK	K9P5
Černá Polomat	109	TGETPREMK	K9M5
Bílá Mat	109	TGETPREMK	KS96
Bílá	102	TGETPREMK	K916
Barvy RAL a speciální barvy*	139	TGETPREMK	K... Kód konfigurace s. 388

* nelze: Black Crocodile New, White Gold, SOFT ani MATT od všech RAL(pouze SOFT 9005, SOFT 9016, SOFT 7047, MATT 7016 a MATT 9016 jde)

Sada rohová termostatická ALL IN ONE

MOŽNOSTI BAREVNÝCH ÚPRAV:

Ve všech Barvách RAL, barvách Premium a speciálních barvách*.

PŘIPOJENÍ:

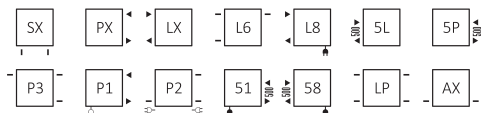

DOSTUPNÉ VERZE:

SADA OBSAHUJE:

Ventil rohový termostatický
Sada krycí
Ventil rohový uzavírací

2 × Adaptér PEX, ALU-PEX 16×2
Termostatická hlavice M30 × 1.5
2 × Adaptér CU Ø 15

Skladem v barvách: Chrom, Černá, Černá Polomat, Bílá Mat, Bílá

Barva	Cena bez DPH u barev Premium +25% do barev RAL [EUR]	Kód produktu	Kód konfigurace
Chrom	114	TGETROYTK	KCRO
Černá	121	TGETROYTK	K9P5
Černá Polomat	121	TGETROYTK	K9M5
Bílá Mat	121	TGETROYTK	KS96
Bílá	114	TGETROYTK	K916
Barvy RAL a speciální barvy*	149	TGETROYTK	K... Kód konfigurace s. 388

* nelze: Black Crocodile New, White Gold, SOFT ani MATT od všech RAL (pouze SOFT 9005, SOFT 9016, SOFT 7047, MATT 7016 a MATT 9016 jde)

Sada krycí integrovaná

MOŽNOSTI BAREVNÝCH ÚPRAV:



PŘIPOJENÍ:

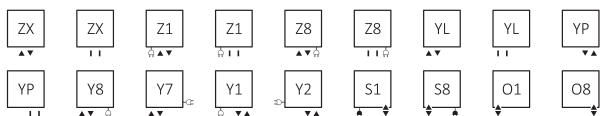

SADA OBSAHUJE:

Krytka otvorů a ALU-PEX nebo Cu trubek ze zdi, hranatá,
pro ventily na osu 50mm
2 × kulatý krycí profil od zdi k ventilu, 50mm

Barva	Cena bez DPH u barev Premium +25% do barev RAL [EUR]	Kód produktu	Kód konfigurace
Chrom	24	TGPZMRP1	KCRO
Bílá	24	TGPZMRP1	K916
Černá Polomat	24	TGPZMRP1	K9M5
Černá	24	TGPZMRP1	K9P5
Bílá Mat	24	TGPZMRP1	KS96

Sada rohová regulační „Classic Art”

MOŽNOSTI BAREVNÝCH ÚPRAV:



PŘIPOJENÍ:

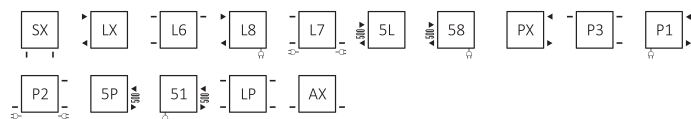

Velikost	Barva	Cena bez DPH [EUR]	Kód produktu ...Kód konfigurace s. 390
GZ 1/2" – Ø16x2, Ø15, GW 1/2"	Antracit	199	TGERANT01
GZ 1/2" – Ø16x2, Ø15, GW 1/2"	Bronz kartáčovaný	209	TGERANT03
GZ 1/2" – Ø16x2, Ø15, GW 1/2"	V barvě radiátoru (vzorník speciálních barev pro litinové radiátory a vzorník RAL)	210	WRZRRAW01...

Sada rohová regulační „Minimalist”

MOŽNOSTI BAREVNÝCH ÚPRAV:



PŘIPOJENÍ:

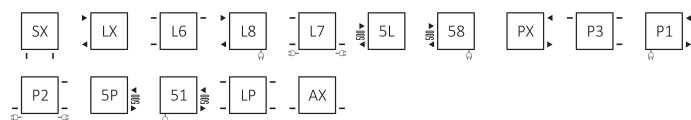

Velikost	Barva	Cena bez DPH [EUR]	Kód produktu ...Kód konfigurace s. 390
GZ 1/2" – Ø16x2, Ø15	Antracit	228	TGERAN002
GZ 1/2" – Ø16x2, Ø15	Bronz kartáčovaný	228	TGERBR002
GZ 1/2" – Ø16x2, Ø15	Měď kartáčovaná	228	TGERME003
GZ 1/2" – Ø16x2, Ø15	Nikl satén	228	TGERST005
GZ 1/2" – Ø16x2, Ø15	Chrom	228	TGZR017
GZ 1/2" – Ø16x2, Ø15	V barvě radiátoru (vzorník speciálních barev pro litinové radiátory a vzorník RAL)	228	WRZRRAW03...

Sada rohová termostatická „Artistic”

MOŽNOSTI BAREVNÝCH ÚPRAV:



PŘIPOJENÍ:

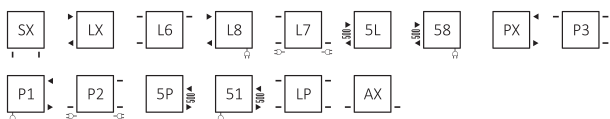

Velikost	Barva	Cena bez DPH [EUR]	Kód produktu <small>... Kód konfigurace s. 390</small>
GZ 1/2" – Ø16x2, Ø15	Antracit	190	TGETAN002
GZ 1/2" – Ø16x2, Ø15	Bronz kartáčovaný	190	TGETBR003
GZ 1/2" – Ø16x2, Ø15	V barvě radiátoru (vzorník speciálních barev pro litinové radiátory a vzorník RAL)	190	WRZTKAR01 ...

Sada rohová termostatická „Wood”

MOŽNOSTI BAREVNÝCH ÚPRAV:



PŘIPOJENÍ:

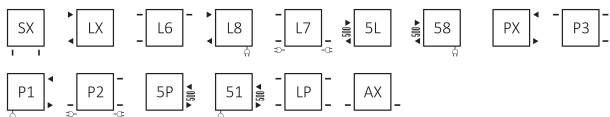

Velikost	Barva	Cena bez DPH [EUR]	Kód produktu
GZ 1/2" – Ø16x2, Ø15	Bronz kartáčovaný	209	TGETBR002
GZ 1/2" – Ø16x2, Ø15	Nikl satén	209	TGETST005
GZ 1/2" – Ø16x2, Ø15	Měď kartáčovaná	209	TGETME001

Sada krycí dvojitá „Artistic”

MOŽNOSTI BAREVNÝCH ÚPRAV:



Velikost	Barva	Cena bez DPH [EUR]	Kód produktu ... Kód konfigurace s. 390
Ø18/Ø50/L160	Antracit	64	TGPAN001
Ø18/Ø50/L160	Bronz kartáčovaný	52	TGPBR001
Ø18/Ø50/L160	V barvě radiátoru (vzorník speciálních barev pro litinové radiátory a vzorník RAL)	66	WRMRAW01...

Sada krycí dvojitá

MOŽNOSTI BAREVNÝCH ÚPRAV:

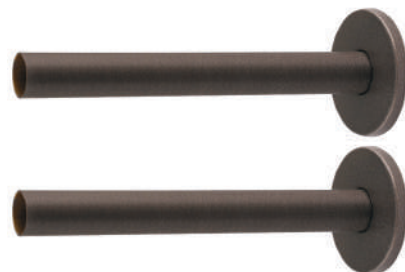
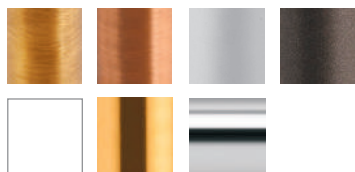

Velikost	Barva	Cena bez DPH [EUR]	Kód produktu ... Kód konfigurace s. 390
Ø18/Ø50/L160	Bronz kartáčovaný	44	TGPBR002
Ø18/Ø50/L160	Měď kartáčovaná	44	TGPME001
Ø18/Ø50/L160	Nikl satén	44	TGPNI001
Ø18/Ø50/L160	Antracit	41	TGPAN002
Ø18/Ø50/L160	Bílá	35	TGPBI001
Ø18/Ø50/L160	Mosaz	31	TGPMS001
Ø18/Ø50/L160	Chrom	33	TGPCR004
Ø18/Ø50/L160	Černá	35	TGPCZ001
Ø18/Ø50/L160	Černá Mat	34	TGPCM001
Ø18/Ø50/L160	Zlatá	50	TGPZL002
Ø18/Ø50/L160	V barvě radiátoru (vzorník speciálních barev pro litinové radiátory a vzorník RAL)	49	WRMRAW02...

Adaptér AL-PEX – 24 × 19

MOŽNOSTI BAREVNÝCH ÚPRAV:



Velikost	Barva	Cena bez DPH [EUR]	Kód produktu <small>... Kód konfigurace s. 390</small>
GW 24-19 – Ø16x2	Nikl satén	14	TGAST019
GW 24-19 – Ø16x2	Bronz kartáčovaný	14	TGABS006
GW 24-19 – Ø16x2	Antracit	14	TGAAN001
GW 24-19 – Ø16x2	Měď kartáčovaná	14	TGAME001
GW 24-19 – Ø16x2	Mosaz	14	TGAMS001
GW 24-19 – Ø16x2	V barvě radiátoru (vzorník speciálních barev pro litinové radiátory a vzorník RAL)	15	WRAADAP01...

Adaptér na ocel – 24 × 19

MOŽNOSTI BAREVNÝCH ÚPRAV:



Velikost	Barva	Cena bez DPH [EUR]	Kód produktu <small>... Kód konfigurace s. 390</small>
GW 24-19-GW 1/2"	Nikl satén	16	TGAST020
GW 24-19-GW 1/2"	Bronz kartáčovaný	16	TGABS005
GW 24-19-GW 1/2"	Antracit	16	TGAAN003
GW 24-19-GW 1/2"	Měď kartáčovaná	16	TGAME003
GW 24-19-GW 1/2"	Mosaz	16	TGAMS003
GW 24-19-GW 1/2"	V barvě radiátoru (vzorník speciálních barev pro litinové radiátory a vzorník RAL)	17	WRAADAP02...

Adaptér na měď – 24 × 19

MOŽNOSTI BAREVNÝCH ÚPRAV:



Velikost	Barva	Cena bez DPH [EUR]	Kód produktu <small>... Kód konfigurace s. 390</small>
GW 24-19 – Ø15	Nikl satén	14	TGAST018
GW 24-19 – Ø15	Bronz kartáčovaný	14	TGABS003
GW 24-19 – Ø15	Antracit	14	TGAAN002
GW 24-19 – Ø15	Měď kartáčovaná	14	TGAME002
GW 24-19 – Ø15	Mosaz	14	TGAMS002
GW 24-19 – Ø15	V barvě radiátoru (vzorník speciálních barev pro litinové radiátory a vzorník RAL)	15	WRAADAP03...

Odvzdušňovací ventil

MOŽNOSTI BAREVNÝCH ÚPRAV:



Velikost	Barva	Cena bez DPH [EUR]	Kód produktu <small>... Kód konfigurace s. 390</small>
1/2"	Chrom	9	TGIOCR002...
1/2"	V barvě radiátoru (vzorník speciálních barev pro litinové radiátory a vzorník RAL)	10	PLVODP01...

Redukce 5/4" x 1/2"

V barvě vybraného radiátoru.



Velikost	Orientace	Cena bez DPH [EUR]	Kód produktu ...Kód konfigurace s. 390
5/4"	levá	4	PLVKOR-Z01...
5/4"	pravá	4	PLVKOR-Z02...

Zátka EUro 5/4"

V barvě vybraného radiátoru.



Velikost	Orientace	Cena bez DPH [EUR]	Kód produktu ...Kód konfigurace s. 390
5/4"	levá	4	PLVKOR-Z03...
5/4"	pravá	4	PLVKOR-Z04...

Vsuvka pro spojení článků 5/4"



Materiál	Cena bez DPH [EUR]	Kód produktu
Litina	2	MMECSGZ0011
Ocel	1	MMECSGZ0018

Těsnění pro litinový radiátor



Velikost	Cena bez DPH [EUR]	Kód produktu
5/4"; tl. 1,5 mm	1	MTSININ0053

Montážní klíč na spojování článků



Velikost	Cena bez DPH [EUR]	Kód produktu
800 mm (10 článků po 80 mm)	143	WRNGZ600

Hák



Radiátor	Barva	Cena bez DPH [EUR]	Kód produktu <small>Kód konfigurace s. 390</small>
Oxford i Plain 3K	V barvě radiátoru (vzorník speciálních barev pro litinové radiátory a vzorník RAL)	11	PLV-HAK-220...
Plain i Kaszub	V barvě radiátoru (vzorník speciálních barev pro litinové radiátory a vzorník RAL)	11	PLV-HAK-180...
Bart	V barvě radiátoru (vzorník speciálních barev pro litinové radiátory a vzorník RAL)	11	PLV-HAK-070...

Ventily a příslušenství

Komplexní integrovaný termostatický ventil s ponornou trubicí

VENTIL ROHOVÝ - 90°

DOSTUPNÉ VERZE:



Levá



Pravá

NEZAPOMEŇTE KOUPIIT:

Adaptéry
Termostatická hlavice
Sada krycí



MOŽNOSTI BAREVNÝCH ÚPRAV:



Orientace	Velikost	Barva	Cena bez DPH [EUR]	Kód produktu
Levá	GZ 1/2" – GZ 3/4"	Bílá	99	TGZTBI008
Pravá	GZ 1/2" – GZ 3/4"	Bílá	99	TGZTBI009
Levá	GZ 1/2" – GZ 3/4"	Chrom	97	TGZTCR019
Pravá	GZ 1/2" – GZ 3/4"	Chrom	97	TGZTCR018
Levá	GZ 1/2" – GZ 3/4"	Satén	129	TGZTST017
Pravá	GZ 1/2" – GZ 3/4"	Satén	129	TGZTST016
Levá	GZ 1/2" – GZ 3/4"	Černá	99	TGZTCZ006
Pravá	GZ 1/2" – GZ 3/4"	Černá	99	TGZTCZ007
Levá	GZ 1/2" – GZ 3/4"	Černá Mat	129	TGZTCM006
Pravá	GZ 1/2" – GZ 3/4"	Černá Mat	129	TGZTCM007
Levá	GZ 1/2" – GZ 3/4"	Zlatá	177	TGZTZL001
Pravá	GZ 1/2" – GZ 3/4"	Zlatá	177	TGZTZL002

Komplexní integrovaný termostatický ventil přímý s ponornou trubicí

DOSTUPNÉ VERZE:

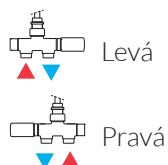

NEZAPOMEŇTE KOUPIT:

Adaptéry
Termostatická hlavice
Sada krycí



MOŽNOSTI BAREVNÝCH ÚPRAV:



Orientace	Velikost	Barva	Cena bez DPH [EUR]	Kód produktu
—	GZ 1/2" – GZ 3/4"	Bílá	100	TGZTBI010
—	GZ 1/2" – GZ 3/4"	Chrom	93	TGZTCR18
—	GZ 1/2" – GZ 3/4"	Satén	117	TGZTST018
—	GZ 1/2" – GZ 3/4"	Černá Mat	117	TGZTCM010

Komplexní integrovaný termostatický ventil

VENTIL ROHOVÝ - 90°

DOSTUPNÉ VERZE:



Levá



Pravá

NEZAPOMEŇTE KOUPIIT:

Adaptéry

Termostatická hlavice

Sada krycí



MOŽNOSTI BAREVNÝCH ÚPRAV:



Orientace	Velikost	Barva	Cena bez DPH [EUR]	Kód produktu
Levá	GZ 1/2" – GZ 24x19	Bílá	92	TGZTBI011
Pravá	GZ 1/2" – GZ 24x19	Bílá	92	TGZTBI012
Levá	GZ 1/2" – GZ 24x19	Chrom	90	TGZTCR005
Pravá	GZ 1/2" – GZ 24x19	Chrom	90	TGZTCR006
Levá	GZ 1/2" – GZ 24x19	Satén	112	TGZTST005
Pravá	GZ 1/2" – GZ 24x19	Satén	112	TGZTST006
Levá	GZ 1/2" – GZ 24x19	Černá	105	TGZTCZ001
Pravá	GZ 1/2" – GZ 24x19	Černá	105	TGZTCZ002
Levá	GZ 1/2" – GZ 24x19	Černá Mat	112	TGZTCM001
Pravá	GZ 1/2" – GZ 24x19	Černá Mat	112	TGZTCM002
Levá	GZ 1/2" – GZ 24x19	Zlatá	170	TGZTZL004
Pravá	GZ 1/2" – GZ 24x19	Zlatá	170	TGZTZL006

Komplexní integrovaný termostatický ventil přímý

DOSTUPNÉ VERZE:



Levá



Pravá

NEZAPOMEŇTE KOUPIIT:

Adaptéry
Termostatická hlavice
Sada krycí



MOŽNOSTI BAREVNÝCH ÚPRAV:



Orientace	Velikost	Barva	Cena bez DPH [EUR]	Kód produktu
Levá	GZ 1/2" – GZ 24x19	Bílá	94	TGZTBI019
Pravá	GZ 1/2" – GZ 24x19	Bílá	94	TGZTBI018
Levá	GZ 1/2" – GZ 24x19	Chrom	93	TGZTCR013
Pravá	GZ 1/2" – GZ 24x19	Chrom	93	TGZTCR014
Levá	GZ 1/2" – GZ 24x19	Satén	112	TGZTST012
Pravá	GZ 1/2" – GZ 24x19	Satén	112	TGZTST013
Levá	GZ 1/2" – GZ 24x19	Černá	108	TGZTCZ011
Pravá	GZ 1/2" – GZ 24x19	Černá	108	TGZTCZ010
Levá	GZ 1/2" – GZ 24x19	Černá Mat	112	TGZTCM011
Pravá	GZ 1/2" – GZ 24x19	Černá Mat	112	TGZTCM008

Komplexní integrovaný ventil s T- kusem s možností připojení topné tyče skrze ventil

VENTIL ROHOVÝ – 90°

DOSTUPNÉ VERZE (TOPNÁ TYČ SE MONTUJE NA VÝSTUPU):

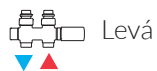

Levá



Pravá

NEZAPOMEŇTE KOUPIIT:

Adaptéry
Termostatická hlavice
Sada krycí



MOŽNOSTI BAREVNÝCH ÚPRAV:



Orientace	Velikost	Barva	Cena bez DPH [EUR]	Kód produktu
Levá	GZ 1/2" – GW 1/2" – GZ 24-19	Bílá	134	TGZTBI013
Pravá	GZ 1/2" – GW 1/2" – GZ 24-19	Bílá	134	TGZTBI014
Levá	GZ 1/2" – GW 1/2" – GZ 24-19	Chrom	128	TGZTCR022
Pravá	GZ 1/2" – GW 1/2" – GZ 24-19	Chrom	128	TGZTCR021
Levá	GZ 1/2" – GW 1/2" – GZ 24-19	Satén	162	TGZTST020
Pravá	GZ 1/2" – GW 1/2" – GZ 24-19	Satén	162	TGZTST021
Levá	GZ 1/2" – GW 1/2" – GZ 24-19	Černá	154	TGZTCZ008
Pravá	GZ 1/2" – GW 1/2" – GZ 24-19	Černá	154	TGZTCZ009
Levá	GZ 1/2" – GW 1/2" – GZ 24-19	Černá Mat	162	TGZTCM013
Pravá	GZ 1/2" – GW 1/2" – GZ 24-19	Černá Mat	162	TGZTCM009

Ventil tříosý uzavírací integrovaný s T- kusem pro připojení topné tyče skrze ventil

DOSTUPNÉ VERZE:

 Levá  Pravá

MOŽNOSTI BAREVNÝCH ÚPRAV:



NEZAPOMEŇTE KOUPIT:

Adaptéry
Sada krycí
Ventil tříosý termostatický
nebo regulační



Orientace	Velikost	Barva	Cena bez DPH [EUR]	Kód produktu
Levá	GZ 1/2" – GW 1/2" – GZ 24x19	Bílá	60	TGZOBI009
Pravá	GZ 1/2" – GW 1/2" – GZ 24x19	Bílá	60	TGZOBI010
Levá	GZ 1/2" – GW 1/2" – GZ 24x19	Chrom	56	TGZO CR010
Pravá	GZ 1/2" – GW 1/2" – GZ 24x19	Chrom	56	TGZO CR012
Levá	GZ 1/2" – GW 1/2" – GZ 24x19	Satén	68	TGZO ST008
Pravá	GZ 1/2" – GW 1/2" – GZ 24x19	Satén	68	TGZO ST010
Levá	GZ 1/2" – GW 1/2" – GZ 24x19	Černá	73	TGZO CZ004
Pravá	GZ 1/2" – GW 1/2" – GZ 24x19	Černá	73	TGZO CZ005
Levá	GZ 1/2" – GW 1/2" – GZ 24x19	Černá Mat	68	TGZO CM004
Pravá	GZ 1/2" – GW 1/2" – GZ 24x19	Černá Mat	68	TGZO CM005

Ventil integrovaný uzavírací (VK)

VENTIL ROHOVÝ - 90°

MOŽNOSTI BAREVNÝCH ÚPRAV:



NEZAPOMEŇTE
KOUPIŤ:

Adaptéry
Termostatická hlavice
Sada krycí



Velikost	Barva	Cena bez DPH [EUR]	Kód produktu
GW 3/4" (GZ 1/2") – GZ M22x1,5	Chrom	56	TGEOCR001
GW 3/4" (GZ 1/2") – GZ M22x1,5	Satén	69	TGEOST001
GW 3/4" (GZ 1/2") – GZ M22x1,5	Černá Mat	76	TGEOCM001

VENTIL PŘÍMÝ

MOŽNOSTI BAREVNÝCH ÚPRAV:



Velikost	Barva	Cena bez DPH [EUR]	Kód produktu
GW 3/4" (GZ 1/2") – GZ M22x1,5	Chrom	56	TGEOCR002
GW 3/4" (GZ 1/2") – GZ M22x1,5	Satén	69	TGEOST002
GW 3/4" (GZ 1/2") – GZ M22x1,5	Černá Mat	76	TGEOCM002

Ventil tříosý termostatický

DOSTUPNÉ VERZE:



MOŽNOSTI BAREVNÝCH ÚPRAV:



NEZAPOMEŇTE KOUPIIT:

Adaptéry
Termostatická hlavice
Sada krycí
Ventil tříosý uzavírací



Orientace	Velikost	Barva	Cena bez DPH [EUR]	Kód produktu
Levá	GZ 1/2" – GZ 24x19	Bílá	52	TGZTBI002
Prává	GZ 1/2" – GZ 24x19	Bílá	52	TGZTBI003
Levá	GZ 1/2" – GZ 24x19	Chrom	52	TGZTCR002
Prává	GZ 1/2" – GZ 24x19	Chrom	52	TGZTCR004
Levá	GZ 1/2" – GZ 24x19	Satén	66	TGZTST002
Prává	GZ 1/2" – GZ 24x19	Satén	66	TGZTST004
Levá	GZ 1/2" – GZ 24x19	Černá	66	TGZTCZ003
Prává	GZ 1/2" – GZ 24x19	Černá	66	TGZTCZ004
Levá	GZ 1/2" – GZ 24x19	Černá Mat	66	TGZTCM003
Prává	GZ 1/2" – GZ 24x19	Černá Mat	66	TGZTCM004
Levá	GZ 1/2" – GZ 24x19	Zlatá	89	TGZTZL003
Prává	GZ 1/2" – GZ 24x19	Zlatá	89	TGZTZL005

Ventil tříosý regulační

DOSTUPNÉ VERZE:



NEZAPOMEŇTE KOUPIIT:

Adaptéry
Sada krycí
Ventil tříosý uzavírací



MOŽNOSTI BAREVNÝCH ÚPRAV:



Orientace	Velikost	Barva	Cena bez DPH [EUR]	Kód produktu
Levá	GZ 1/2" – GZ 24x19	Bílá	51	TGZRBI002
Prává	GZ 1/2" – GZ 24x19	Bílá	51	TGZRBI004
Levá	GZ 1/2" – GZ 24x19	Chrom	46	TGZRRC002
Prává	GZ 1/2" – GZ 24x19	Chrom	46	TGZRRC004
Levá	GZ 1/2" – GZ 24x19	Satén	54	TGZRST002
Prává	GZ 1/2" – GZ 24x19	Satén	54	TGZRST004
Levá	GZ 1/2" – GZ 24x19	Černá	58	TGZRZC002
Prává	GZ 1/2" – GZ 24x19	Černá	58	TGZRZC003
Levá	GZ 1/2" – GZ 24x19	Černá Mat	54	TGZRZCM002
Prává	GZ 1/2" – GZ 24x19	Černá Mat	54	TGZRZCM003
Levá	GZ 1/2" – GZ 24x19	Zlatá	77	TGZRZL003
Prává	GZ 1/2" – GZ 24x19	Zlatá	77	TGZRZL004

Ventil tříosý uzavírací

DOSTUPNÉ VERZE:



Levá Pravá

MOŽNOSTI BAREVNÝCH ÚPRAV:



NEZAPOMEŇTE KOUPIT:

Adaptéry
Sada krycí
Ventil tříosý termostatický
nebo regulační



Orientace	Velikost	Barva	Cena bez DPH [EUR]	Kód produktu
Levá	GZ 1/2" – GZ 24x19	Bílá	51	TGZOBI002
Pravá	GZ 1/2" – GZ 24x19	Bílá	51	TGZOBI004
Levá	GZ 1/2" – GZ 24x19	Chrom	46	TGZO CR002
Pravá	GZ 1/2" – GZ 24x19	Chrom	46	TGZO CR004
Levá	GZ 1/2" – GZ 24x19	Satén	58	TGZO ST002
Pravá	GZ 1/2" – GZ 24x19	Satén	58	TGZO ST004
Levá	GZ 1/2" – GZ 24x19	Černá	58	TGZO CZ002
Pravá	GZ 1/2" – GZ 24x19	Černá	58	TGZO CZ003
Levá	GZ 1/2" – GZ 24x19	Černá Mat	58	TGZO CM002
Pravá	GZ 1/2" – GZ 24x19	Černá Mat	58	TGZO CM003
Levá	GZ 1/2" – GZ 24x19	Zlatá	76	TGZO ZL003
Pravá	GZ 1/2" – GZ 24x19	Zlatá	76	TGZO ZL001

Ventil rohový termostatický

MOŽNOSTI BAREVNÝCH ÚPRAV:



NEZAPOMEŇTE KOUPIT:

Adaptéry
Termostatická hlavice
Sada krycí
Ventil rohový uzavírací



Velikost	Barva	Cena bez DPH [EUR]	Kód produktu
GZ 1/2" – GZ 24x19	Bílá	50	TGZTBI005
GZ 1/2" – GZ 24x19	Chrom	49	TGZTCR009
GZ 1/2" – GZ 24x19	Satén	66	TGZTST009
GZ 1/2" – GZ 24x19	Černá	63	TGZTCZ005
GZ 1/2" – GZ 24x19	Černá Mat	66	TGZTCM005

Ventil rohový regulační

MOŽNOSTI BAREVNÝCH ÚPRAV:



NEZAPOMEŇTE KOUPIIT:

Adaptéry
Sada krycí
Ventil rohový uzavírací



Velikost	Barva	Cena bez DPH [EUR]	Kód produktu
GZ 1/2" – GZ 24x19	Bílá	46	TGZRB1006
GZ 1/2" – GZ 24x19	Chrom	46	TGZR006
GZ 1/2" – GZ 24x19	Satén	52	TGZRST006
GZ 1/2" – GZ 24x19	Černá	56	TGZR001
GZ 1/2" – GZ 24x19	Černá Mat	52	TGZR001
GZ 1/2" – GZ 24x19	Zlatá	70	TGZR001

Ventil rohový uzavírací

MOŽNOSTI BAREVNÝCH ÚPRAV:



NEZAPOMEŇTE KOUPIIT:

Adaptéry
Sada krycí
Ventil rohový termostatický
nebo regulační



Velikost	Barva	Cena bez DPH [EUR]	Kód produktu
GZ 1/2" – GZ 24x19	Bílá	46	TGZOB1006
GZ 1/2" – GZ 24x19	Chrom	46	TGZOCR013
GZ 1/2" – GZ 24x19	Satén	52	TGZOST006
GZ 1/2" – GZ 24x19	Černá	56	TGZOC001
GZ 1/2" – GZ 24x19	Černá Mat	54	TGZOC001
GZ 1/2" – GZ 24x19	Zlatá	70	TGZOZL002

Ventil termostatický přímý

MOŽNOSTI BAREVNÝCH ÚPRAV: NEZAPOMEŇTE KOUPIT:



Adaptéry
Termostatická hlavice
Sada krycí
Ventil uzavírací přímý



Velikost	Barva	Cena bez DPH [EUR]	Kód produktu
GZ 1/2" – GZ 24x19	Bílá	50	TGZTBI006
GZ 1/2" – GZ 24x19	Chrom	49	TGZTCR015
GZ 1/2" – GZ 24x19	Satén	66	TGZTST019

Ventil regulační přímý

MOŽNOSTI BAREVNÝCH ÚPRAV: NEZAPOMEŇTE KOUPIT:



Adaptéry
Sada krycí
Ventil uzavírací přímý



Velikost	Barva	Cena bez DPH [EUR]	Kód produktu
GZ 1/2" – GZ 24x19	Bílá	46	TGZRBI007
GZ 1/2" – GZ 24x19	Chrom	46	TGZRRC009
GZ 1/2" – GZ 24x19	Satén	52	TGZRST007

Ventil uzavírací přímý

MOŽNOSTI BAREVNÝCH ÚPRAV: NEZAPOMEŇTE KOUPIIT:

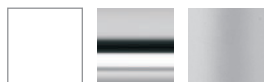

Adaptéry
Sada krycí
Ventil termostatický přímý
nebo regulační přímý



Velikost	Barva	Cena bez DPH [EUR]	Kód produktu
GZ 1/2" – GZ 24x19	Bílá	46	TGZOBI007
GZ 1/2" – GZ 24x19	Chrom	46	TGZOCR008
GZ 1/2" – GZ 24x19	Satén	54	TGZOST012

T- kus

MOŽNOSTI BAREVNÝCH ÚPRAV:



Velikost	Barva	Cena bez DPH [EUR]	Kód produktu
GZ 1/2" – GW 1/2" – GW 1/2"	Bílá	7	WRT1C2 916
GZ 1/2" – GW 1/2" – GW 1/2"	Chrom	8	WRT1C2 CRO
GZ 1/2" – GW 1/2" – GW 1/2"	Satén	7	WRT1C2 SMA
GZ 1/2" – GW 1/2" – GW 1/2"	Černá Polomat	7	WRT1C2 9M5
GZ 1/2" – GW 1/2" – GW 1/2"	Zlatá	16	TGI010

Ventil regulační rohový Minimalist – 24 × 19

NEZAPOMEŇTE KOUPIIT:

Adaptéry
Sada krycí



Velikost	Barva	Cena bez DPH [EUR]	Kód produktu
GZ 1/2" – GZ 24x19	Zlatá	139	TGZRZL010

Ventil regulační rohový Star – 24 × 19

NEZAPOMEŇTE KOUPIIT:

Adaptéry
Sada krycí



Velikost	Barva	Cena bez DPH [EUR]	Kód produktu
GZ 1/2" – GZ 24x19	Zlatá	119	TGZRZL002

Adaptér AL-PEX (šroubení) – 24 × 19

Určený pro ventily se závitem 24x19



MOŽNOSTI BAREVNÝCH ÚPRAV:



Velikost	Barva	Cena bez DPH [EUR]	Kód produktu
GW 24x19 – Ø16x2	Chrom	9	TGACR019
GW 24x19 – Ø16x2	Satén	12	TGAST017
GW 24x19 – Ø16x2	Černá	13	TGACZ001
GW 24x19 – Ø16x2	Černá Mat	12	TGACM001
GW 24x19 – Ø16x2	Bílá	13	TGABI001
GW 24x19 – Ø16x2	Zlatá	27	TGAZL002

Adaptér AL-PEX – 3/4"

Určený pro Komplexní integrovaný termostatický ventil s ponornou trubicí.



MOŽNOSTI BAREVNÝCH ÚPRAV:



Velikost	Barva	Cena bez DPH [EUR]	Kód produktu
GW 3/4" – Ø16x2	Chrom	9	TGACR015
GW 3/4" – Ø16x2	Satén	12	TGAST015
GW 3/4" – Ø16x2	Černá	13	TGACZ005
GW 3/4" – Ø16x2	Černá Mat	12	TGACM002
GW 3/4" – Ø16x2	Bílá	13	TGABI002
GW 3/4" – Ø16x2	Zlatá	27	TGAZL001

Adaptér AL-PEX – M22 × 1,5

Určený pro Ventil integrovaný uzavírací.

MOŽNOSTI BAREVNÝCH ÚPRAV:



Velikost	Barva	Cena bez DPH [EUR]	Kód produktu
GW M22x1,5 – Ø16x2	Chrom	9	TGACR011
GW M22x1,5 – Ø16x2	Satén	12	TGAST011
GW M22x1,5 – Ø16x2	Černá Mat	12	TGACM003

Adaptér (šroubení) na měď – 24 × 19

Určený pro ventily se závitem 24x19.

MOŽNOSTI BAREVNÝCH ÚPRAV:



Velikost	Barva	Cena bez DPH [EUR]	Kód produktu
GW 24x19 – Ø15	Chrom	9	TGACR003
GW 24x19 – Ø15	Satén	12	TGAST003
GW 24x19 – Ø15	Bílá	13	TGABI003
GW 24x19 – Ø15	Zlatá	24	TGAZL003

Pokud potřebujete adaptér na měď v barvě Černá nebo Černá Mat objednejte Adaptér na AL-PEX 24 x 19 v dané barvě obsahující matici v dané barvě + šroubení na měď - Kód produktu TGAZU001 v ceně 2x3 EUR bez DPH.

Adaptér (šroubení) na měď – 3/4"

Určený pro Komplexní integrovaný termostatický ventil s ponornou trubicí.

MOŽNOSTI BAREVNÝCH ÚPRAV:



Velikost	Barva	Cena bez DPH [EUR]	Kód produktu
GW 3/4" – Ø15	Chrom	9	TGACR018
GW 3/4" – Ø15	Satén	12	TGAST014

Pokud potřebujete adaptér na měď v barvě Bílá, Černá, Zlatá nebo Černá Mat objednejte Adaptér na AL-PEX 3/4" v dané barvě obsahující matici v dané barvě + šroubení na měď - Kód produktu TGAZU002 v ceně 2x3 EUR bez DPH.

Adaptér na měď – M22 × 1,5

Určený pro Ventil integrovaný uzavírací.

MOŽNOSTI BAREVNÝCH ÚPRAV:



Velikost	Barva	Cena bez DPH [EUR]	Kód produktu
GW M22x1,5 – Ø15	Chrom	9	TGACR006
GW M22x1,5 – Ø15	Satén	12	TGAST006
GW M22x1,5 – Ø15	Černá Mat	12	TGACM004

Adaptér (šroubení) na ocel – 24 × 19

Určený pro ventily se závitem 24x19.

MOŽNOSTI BAREVNÝCH ÚPRAV:



Velikost	Barva	Cena bez DPH [EUR]	Kód produktu
GW 24x19 – GW 1/2"	Chrom	12	TGACR007
GW 24x19 – GW 1/2"	Satén	14	TGAST007

Adaptér na ocel – M22 × 1,5

Určený pro Ventil integrovaný uzavírací.

MOŽNOSTI BAREVNÝCH ÚPRAV:



Velikost	Barva	Cena bez DPH [EUR]	Kód produktu
GW M22x1,5 – GW 1/2"	Chrom	12	TGACR012
GW M22x1,5 – GW 1/2"	Satén	14	TGAST012

Termostatická hlavice ETNA

MOŽNOSTI BAREVNÝCH ÚPRAV:



Velikost	Barva	Cena bez DPH [EUR]	Kód produktu
M30x1,5	Bílá	22	TGGBI002
M30x1,5	Chrom	34	TGGCR002

Termostatická hlavice NOBLE

MOŽNOSTI BAREVNÝCH ÚPRAV:



Velikost	Barva	Cena bez DPH [EUR]	Kód produktu
M30x1,5	Bílá	27	TGGBI007
M30x1,5	Chrom	34	TGGCR004
M30x1,5	Satén	43	TGGST002
M30x1,5	Černá	37	TGGCZ001
M30x1,5	Černá Mat	43	TGGCM002

Termostatická hlavice SLIM

MOŽNOSTI BAREVNÝCH ÚPRAV:



Velikost	Barva	Cena bez DPH [EUR]	Kód produktu
M30x1,5	Bílá	37	TGGBI001
M30x1,5	Chrom	38	TGGCR001
M30x1,5	Satén	63	TGGST001
M30x1,5	Černá	56	TGGCZ002
M30x1,5	Černá Mat	63	TGGCM001
M30x1,5	Zlatá	73	TGGZL001

Zátka (7mm vystupující z otvoru)

MOŽNOSTI BAREVNÝCH ÚPRAV:



Velikost	Barva	Cena bez DPH [EUR]	Kód produktu
GZ 1/2"	Chrom	5	MMEHYKR0001
GZ 1/2"	Satén	5	TGIKST001

Zátka schovaná v otvoru (jen 3mm vystupující)

MOŽNOSTI BAREVNÝCH ÚPRAV:

vzorník RAL, Speciálních barev, barev Premium, Chrom



Velikost	Barva	Cena bez DPH [EUR]	Kód produktu
GZ 1/2"	Bílá	6	WRZK001-BI
GZ 1/2"	Chrom	6	WRZK001-CR

Distanční matice

MOŽNOSTI BAREVNÝCH ÚPRAV:



Velikost 1/2" Velikost 24x19

Velikost	Barva	Cena bez DPH [EUR]	Kód produktu
GW 1/2" – GZ 1/2"	Chrom	6	TGUCR001
GW 1/2" – GZ 1/2"	Satén	8	TGUST001
GW 24x19 – GZ 24x19	Chrom	6	TGUCR002
GW 24x19 – GZ 24x19	Satén	8	TGUST002

Odvzdušňovací ventil

MOŽNOSTI BAREVNÝCH ÚPRAV:

vzorník RAL, Speciálních barev, barev Premium, Chrom



Velikost 1/4"



Velikost	Barva	Cena bez DPH [EUR]	Kód produktu
GZ 1/2"	Bílá	7	WRZ0001-BI
GZ 1/2"	Chrom	6	WRZ0001-CR
GZ 1/4"	Nikl	9	MMEHYOD0005

Sada krycí dvojité

MOŽNOSTI BAREVNÝCH ÚPRAV:



Velikost	Barva	Cena bez DPH [EUR]	Kód produktu
Ø18/Ø55/L160 mm	Bílá	35	TGPBI001
Ø18/Ø55/L70 mm	Chrom	27	TGPCR001
Ø18/Ø55/L70 mm	Satén	34	TGPST001
Ø18/Ø55/L160 mm	Černá	35	TGPCZ001
Ø18/Ø55/L160 mm	Černá Mat	34	TGPCM001
Ø18/Ø55/L160 mm	Chrom	33	TGPCR004
Ø18/Ø55/L160 mm	Zlatá	50	TGPZL002

Sada krycí integrovaná

MOŽNOSTI BAREVNÝCH ÚPRAV:



Velikost	Barva	Cena bez DPH [EUR]	Kód produktu
Ø18/ rozteč 50 mm; L70mm	Bílá	51	TGPBI005
Ø18/ rozteč 50 mm; L70mm	Chrom	38	TGPCR002
Ø18/ rozteč 50 mm; L70mm	Satén	51	TGPST003
Ø18/ rozteč 50 mm; L70mm	Černá	51	TGPCZ002
Ø18/ rozteč 50 mm; L70mm	Černá Mat	51	TGPCM002
Ø18/ rozteč 50 mm; L70mm	Zlatá	62	TGPZL001

Sada speciálních klíčů TERMA

Klíče pasují pro montáž TERMA příslušenství a topných tyčí.

TYP:

Plochý oboustranný

VELIKOST:

20-22, 22-24, 26-27, 27-28

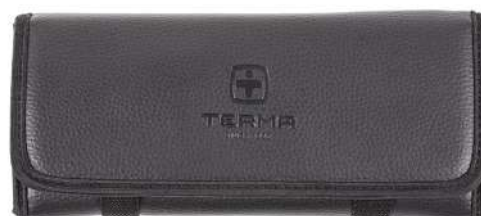

Velikost	Cena bez DPH [EUR]	Kód produktu
20-22, 22-24, 26-27, 27-28	57	WRNKPS0001

Prodlužovací trubice

Pro připojení ventilů k ústřednímu vytápění s výstupem GW 1/2"



Velikost	Barva	Cena bez DPH [EUR]	Kód produktu
GZ 1/2" x Ø15 x 150mm	Chrom	7	TGUMS004

Čistící kartáč dlouhý

Materiál: buk a přírodní žíně.



Velikost	Cena bez DPH [EUR]	Kód produktu
1000 mm	19	TGI007

Čistící kartáč Ribbon

Materiál: buk a přírodní žíně.



Velikost	Cena bez DPH [EUR]	Kód produktu
-	19	TGI009

Sprchové sedátko DIS

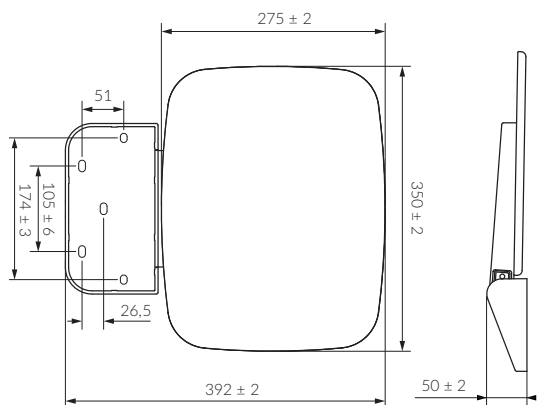

Sprchové sedátko DIS je pohodlné řešení, které vám umožní pohodlně používat sprchu a užít si příjemnou relaxaci po náročném dni.

Je vyrobeno z odolného materiálu Duroplast odolného proti poškrábání, který se používá i při výrobě kvalitních WC sedátek. Díky možnosti sklopení moc místa nezabere - po sklopení má hloubku jen 52 mm od stěny. Použité materiály a jednoduchá konstrukce umožňují udržovat sedátko v čistotě.



Výrobek je dostupný v bílé barvě s chromovaným plastovým krytem montážního držáku nebo v černé barvě. Montážní sada Fischer, která je součástí sady, zajistí vysokou odolnost při zatížení (doporučené maximální zatížení je 130 kg).

Výrobek je ideální pro každý sprchový kout.

Sedačka byla testována v souladu s požadavky EN 12520: 2016 a EN 1728: 2012 v laboratoři Certifikačního orgánu TÜV Rheinland.

Doporučená montážní výška sedáku: cca 40–45 cm od podlahy nebo od úrovně sprchové vaničky

SPECIFIKACE:

Rozměry [mm]	Hloubka [mm]	Hloubka po sklopení [mm]	Barva	Váha  [kg]	Maximální doporučené zatížení  [kg]	Cena bez DPH [EUR]	Kód produktu
350	392	52	bílá s chromem	2,75	130	105	TGSBI001
350	392	52	černá	2,75	130	110	TGSCZ001

Všeobecné obchodní podmínky

Tento dokument stanoví Všeobecné obchodní podmínky mezi společností TERMA Sp. z o. o., dále jen „Výrobce“ a každým podnikatelem, který je zapsán v obchodním rejstříku v souladu s právními předpisy platnými v místě výkonu jeho podnikání, dále jen „Obchodní Partner“. Obchodní Partner učiněním závazné objednávky a uzavřením smlouvy potvrzuje, že akceptuje tyto Všeobecné obchodní podmínky.

1. Pravidla správného používání produktů.

A. Radiátory od tohoto Výrobce jsou určeny k montáži do otopných soustav, které se shodují se současnými polskými a evropskými normami, zejména s normou PN-B-02414 „Vytápění“; ochrana instalací teplovodního vytápění v uzavřených soustavách s membránovou expanzní nádobou a s normou PN-93/C-04607 „Voda v instalacích teplovodního vytápění. Požadavky a výzkum kvality vody“, s pozdějšími změnami.

B. Radiátory mají Prohlášení o Shodě v souladu s nařízením Evropského parlamentu a Rady (EU) č. 305/2011 ze dne 9. března 2011, kterým se stanoví harmonizované podmínky pro uvádění stavebních výrobků na trh a kterým se ruší směrnice Rady 89/106/EHS.

C. Topné tyče od tohoto Výrobce jsou určeny k montáži do radiátorů plněných olejem s viskozitou menší než nebo rovnou 4-5 mm²/s při teplotě 40 ° C, radiátorů plněných vodou s nemrznoucí směsí určenou k přímému kontaktu s topnými prvky, v souladu s návodem k použití přiloženým k výrobku, nebo pro radiátory k ústřednímu topení. Je nepřipustné, aby topné médium v radiátoru zamrzlo.

D. Topné tyče mají prohlášení o shodě a s ním spojené označení CE, jež potvrzují shodu s příslušnými normami a směnicemi Evropské unie, jako jsou:

- směrnice pro nízké napětí (LVD) 2006/95/EC.
- směrnice EMC 2004/108 / EC týkající se elektromagnetické kompatibility.
- směrnice Evropského Parlamentu a Rady EMC 2009/125/WE týkající se ECO designu.

E. Radiátory, topné tyče, vzpěry, sanitární držáky a madla musí být instalovány v souladu s předpoklady instalace a technickou dokumentací Výrobce, která je součástí montážního a provozního návodu dodávaného s tímto produktem.

F. Teplota a tlak topného média, které jsou přípustné pro určitý model radiátoru nebo topné tyče, nesmí být vyšší, než je to uvedeno v technické specifikaci výrobku umístěné v technickém katalogu vedle výrobku a na produktových kartách.

G. Čištění radiátoru, držáků, vzpěr a sanitárních madel by mělo být provedeno měkkou utěrkou za sucha, nebo – navlhčenou – v čisté vodě. Je zakázáno používat jiné chemické prostředky (zvláště prostředky s leptavými účinky) a materiály s abrazivními vlastnostmi.

H. Povrch radiátorů, madel, držáků a vzpěr nesmí být pokryt jakýmkoliv nátěrem nebo lakem, než barvou a lakem Výrobce.

I. Věšení předmětů napuštěných aktivními látkami na výrobcích s chromovaným povlakem je zakázáno, protože to může způsobit změnu barvy nebo jiné poškození povlaku. K údržbě chromovaných radiátorů doporučujeme používat mastné látky (např. přípravek k údržbě chromovaných povrchů), který zajistí optimální a žádanou ochranu před vnějšími faktory. Nelze čistit povrch chromovaného radiátoru prostředky, které obsahují chlor nebo používat k tomu materiály s abrazivními vlastnostmi.

J. Aby nedošlo k poškození tkaniny, dejte pozor na pro ně povolenou teplotu sušení. Zajištění správné teploty rovněž zabrání poškození povrchové úpravy Designového a el. radiátoru. Nezapomínejte na tkaniny, které mají barvicí vlastnosti (nové ručníky, směsi s chemickými vlákny), ale také tkaniny napuštěné chemickými látkami. Může to způsobit zbarvení povrchové úpravy radiátoru. Záruka Výrobce se nevztahuje na vady tohoto typu.

K. Montážní zóny radiátorů a sanitárních madel, držáků a vzpěr. Zóna „X“ znamená zdroj vody (umyvadlo, sprchový kout, vana, záchod, bidet atd.) a nesmí se v ní montovat radiátory pro zachování bezpečnosti a záruky.

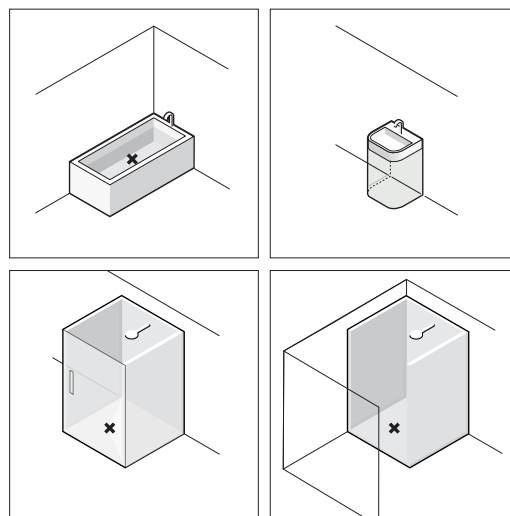

L. Abyste zabránili korozi závitů radiátorů doporučujeme při instalaci využít odborné montážní topeňářské firmy.

2. Objednávka.

A. Jakmile začne spolupráce a vždy po každé změně nebo úpravě údajů, je Obchodní Partner povinen předložit Výrobci ke dni objednávky platné registrační doklady společnosti, které uvádějí formu podnikání a potvrzují daňový status. Zákazníci z území Evropské unie jsou též povinni předložit číslo, jež bylo jim přiděleno za účelem usnadnění obchodu v Evropském společenství. Osoby samostatně výdělečně činné musí kromě toho uvést svou adresu bydliště a rodné číslo.

- B. Výrobce na základě individuální smlouvy s Obchodním Partnerem může stanovit hodnotu maximálního kreditu po a před splatností a platební lhůtu.
- C. Výrobce přijímá objednávky:
- elektronickou cestou (e-mailem),
 - výměnou dat mezi různými kompatibilními systémy s operačním systémem Výrobce.
- D. Objednávka výrobku musí obsahovat produktový kód a konfigurační kód a počet objednaných kusů určitého modelu v souladu s pokyny uvedenými v aktuálním ceníku Výrobce nebo individuálním ceníku Obchodního Partnera, jenž tvoří přílohu smlouvy.
- E. Objednávka nestandardního/ojedinělého zboží vyráběného dle individuálních požadavků musí být doplněna výkresem, nákresem a jasným slovním popisem, jenž umožní správné pochopení konstrukčních předpokladů nabídky.
- F. V případě nekompletních objednávek (chybějící výše uvedené údaje) nebo když je potřeba upřesnit objednávku, Výrobce bude přímo kontaktovat Obchodního Partnera, aby domluvil podrobnosti objednávky. Při objednávání zboží je Obchodní Partner povinen uvést kontaktní údaje osoby určené k realizaci zakázky. Nebudou-li poskytnuty výše uvedené údaje, může to mít za následek prodloužení termínu realizace objednávky. Realizace objednávky tak může být v rozporu s očekáváním Obchodního Partnera nebo objednávka nebude realizována. V takovém případě Výrobce nenese odpovědnost za realizaci, která není v souladu s očekáváním Obchodního partnera.
- G. Objednávka je přijata k realizaci v okamžiku, když Obchodní Partner obdrží od Výrobce zpětnou vazbu ze skladu, či výroby ve formě Proforma dokumentu pro kontrolu správnosti objednaného zboží, kusů, ceny, rabatů a adresy dodání a provedení úhrady nebo Potvrzení objednávky, které bude informovat o předpokládaném termínu dodání. Termín se z výrobních důvodů může měnit, při nedokonalé 100%-ní jakosti se může produkt vyrábět i znovu a dodání se opozdit.
- H. Automaticky se generuje číslo objednávky ZS/..., které je zasláno v Proforma dokumentu nebo Potvrzení, kdy je Obchodní Partner povinen upozornit, pokud nebude v Potvrzení objednávky správně pro výrobu nebo zaslání definováno objednané zboží. Případné reklamace budou posuzovány jen zda bylo dodáno, zboží vyráběné podle Potvrzení objednávky od Výrobce. Číslo ZS/... umožňuje kontrolu objednávky a stavu jejího vyřizování.
- I. Objednávky jsou přijímány v nepřetržitém režimu, takže neexistuje možnost zrušení objednávky po zahájení výrobního procesu. V situacích, které vyžadují změnu konfigurace objednávky, okamžitě kontaktujte Prodejní Tým, který ověří, zda je možné provést změny v objednávce.
- J. Každá změna objednávky může vést k prodloužení doby realizace objednávky a dodávky o dobu nezbytnou pro provedení změn zakázky.

3. Cena.

- A. Prodejní ceny jsou uvedeny v měně EUro. Ceny, jestliže smlouva, obchodní nabídka nebo podmínky pro danou zemi prodeje nestanoví jinak, jsou cenami EXW podle standardu INCOTERMS 2010.

- B. Ceník produktů s cenami bez DPH je zaslán Obchodnímu Partnerovi v elektronické podobě nebo jako příloha ke smlouvě.
- C. Individuální nabídka je platná 30 dní, není-li v nabídce stanoveno jinak.
- D. V případě plánované změny cen je Obchodní Partner informován nejpozději 1 měsíc před touto změnou.
- E. Obchodní Partner je povinen zaplatit za zboží, ve lhůtě stanovené v Proforma dokumentu nebo prodejním dokladu. Nezaplacení ve stanovené lhůtě, může mít za následek výpočet záporných úroků z prodlení za každý den.
- F. Za datum platby se považuje datum připsání finančních prostředků na bankovní účet Výrobce. Veškeré náklady spojené s převodem hradí Kupující.

4. Dodání zboží.

- A. U objednávek přesahujících logistické minimum náklad na dopravu hradí Výrobce. Logistické minimum činí:
- v Polsku – neexistuje žádné logistické minimum,
 - za hranice Polska - logistické minimum a cena dopravy je dohodnuta individuálně s Obchodním Partnerem,
 - v EU a Norsku - doprava zdarma při objednávce v celkové výši přesahující částku 3000 EUR
 - mimo EU a Norsko – logistické minimum a náklady na dodávku jsou individuálně sjednávány s Obchodním Partnerem.
- B. Termíny realizace produktů:
- Výrobce má celou řadu produktů skladem, ale taky vyrábí na zakázku. Informace o produktech skladem najdete v aktuálním ceníku Výrobce, nebo obdržíte na požádání.
 - Produkty na zakázku jsou realizovány do 23 pracovních dnů, pokud není Výrobce nijak výrobně omezen, nebo v závislosti na druhu výrobku.
 - Výše uvedené lhůty se nevztahují na nekatalogové, investiční, atypové objednávky a katalogové objednávky na více než 10 ks jednoho produktu. U tohoto typu objednávek jsou lhůty sjednávány individuálně.
 - Každá objednávka je potvrzena z hlediska obsahu a plánovaného termínu výroby během 2 pracovních dnů od jejího obdržení. Potvrzení objednávky je zasláno e-mailem na adresu nastavenou v systému, uvedenou při zahájení spolupráce.
- C. Doba dodání.
- Standardní doba dodání hotových produktů na území ČR a SR je do 3 pracovních dnů od data vyslání od Výrobce.
 - K dodacím lhůtám mimo území Polska by měla být přidána doba pro přepravu produktů, která se může lišit v závislosti na vzdálenosti nebo postupech celního odbavení.
 - Výrobce nenese odpovědnost vůči Obchodnímu Partnerovi za zpoždění dodávky, ke kterému došlo vinou dopravce.
- D. Výrobce nepřijímá vrácení zboží, ve výjimečných případech po předchozí dohodě s Regionálním Manažerem.
- E. Obchodní Partner je povinen po obdržení objednaného zboží provést okamžitou kontrolu, aby mohl zjistit případné poškození při přepravě. Jakákoli poškození, byť jen poškození balení Kartónu při přepravě by měla být zaznamenána a popsána v přepravních

dokladech dopravce nebo el. záznamu, který si Partner vyžádá a podepsána řidičem. Aby Výrobce uznal nárok Obchodního Partnera z titulu vad zboží, vzniklých při jeho přepravě, je Obchodní Partner povinen sepsat s řidičem přepravní služby protokol o poškození nebo si vyžádat el.záznam ve lhůtě stanovené v přepravních podmínkách a odeslat jej Výrobci nejpozději do 3 pracovních dnů od data jeho sepsání. Nebude-li sepsán protokol o poškození Obchodním partnerem a odeslán Výrobci ve výše uvedených lhůtách, Výrobce bude zbaven odpovědnosti za vady zboží, jež vznikly při přepravě. Použije-li Obchodní Partner vlastní nebo jinou dopravu, odpovědnost Výrobce za poškození při přepravě zaniká okamžikem předání zboží přepravci (Obchodnímu Partnerovi).

F. Produkty dodávané Výrobce jsou určeny k použití v zemi, jež byla označena Obchodním Partnerem jako místo dodání. Další distribuce produktů Obchodním Partnerem – jednotlivě nebo v integrované podobě mimo země dodání - podléhá vývozním ustanovením dané země. Obchodní Partner je povinen získat informace o příslušných předpisech a postupech týkajících se vývozu zboží do třetích zemí.

5. Záruční podmínky.

A. Výrobce dává Obchodnímu partnerovi záruku na produkty, které nabízí a ten ji pak poskytuje koncovému zákazníkovi. Mimo případy, kdy zboží leželo u Obchodního partnera. Poté musí zboží prodat v akci a informovat zákazníka o kratší záruční době, která bude jen do max. záruky Výrobce od data výroby:

- 10 let na těsnost odlévaných hliníkových radiátorů smontovaných v závodě Výrobce
- 8 let na povrchovou úpravu ocelových radiátorů ve všech barvách podle vzorníku RAL a speciálních barvách
- 8 let na povrchovou úpravu litinových radiátorů ve všech barvách podle vzorníku RAL a vybraných speciálních barvách pro litinové radiátory
- 8 let na těsnost ocelových a litinových radiátorů smontovaných v závodě Výrobce
- 4 roky na povrchovou úpravu chromovaných radiátorů
- 3 roky na povrchovou úpravu hliníkových radiátorů
- 2 roky na vybranou povrchovou úpravu litinových radiátorů

Elektrické topné tyče do radiátorů a elektrické komponenty do elektrických radiátorů

- 2 roky

Sanitární držáky, madla a vzpěry:

- 3 roky na povrchovou úpravu produktů ve všech barvách podle vzorníku RAL a speciálních barvách, a také na chrom Příslušenství pro radiátory a topné tyče:
- 2 roky

B. Záruční doba trvá přesně od okamžiku, kdy bylo zákazníkovi předáno zakoupené zboží, za předpokladu, že:

V případě topných tyčí:

- záruční doba je 2 roky od data nákupu, ale ne déle než 3 roky od data výroby.

V případě ocelových radiátorů:

- záruční doba na povrchovou úpravu a těsnost je 8 let, ale ne déle než 9 let od data výroby
- záruční doba na chromovanou povrchovou úpravu je 4 roky, ale ne déle než 5 let od data výroby

V případě litinových radiátorů:

- záruční doba na povrchovou úpravu je 2 roky, ale ne déle než 3 roky od data výroby Na těsnost souprav smontovaných výrobcem: Záruční doba je 8 let, ale ne déle než 9 let od data výroby

V případě sanitárních madel, držáků a vzpěr:

- záruční doba je 3 roky, ale ne déle než 4 roky od data výroby

V případě chromovaného Příslušenství pro radiátory a topné tyče:

- záruční doba je 2 roky, ale ne déle než 3 roky od data výroby

C. V momentě převzetí je Koncový klient povinen zkontrolovat jakost, kompletnost a shodu s jeho objednávkou. V případě zjištění jakýchkoliv vad je Klient povinen do bezodkladného nahlášení vady Obchodnímu Partnerovi, tzn. svému Prodejci před přistoupením k montáži. V případě nenahlášení vad Klientem do 7 kalendářních dnů od převzetí výrobku, přijímá se, že Prodejce předal výrobek bez vad a Klient tak výrobek přebral bez vad.

Klient je povinen po obdržení objednaného zboží provést okamžitou kontrolu, aby mohl zjistit případné poškození při přepravě. Jakákoli poškození, byť jen poškození balení Kartónu při přepravě by měla být zaznamenána a popsána v přepravních dokladech dopravce nebo v obdržném el. záznamu a podepsána řidičem. Aby Výrobce uznal nárok Obchodního Partnera z titulu vad zboží, vzniklých při jeho přepravě, je Klient povinen sepsat s řidičem přepravní služby protokol o poškození ve lhůtě stanovené v přepravních podmínkách a odeslat jej Prodejci nejpozději do 3 pracovních dnů od data jeho sepsání. Nebude-li sepsán protokol o poškození a přes Obchodního partnera odeslán Výrobci ve výše uvedených lhůtách, Výrobce bude zbaven odpovědnosti za vady zboží, jež vznikly při přepravě.

D. Reklamace nahlášená Spotřebitelem se z titulu poskytnuté záruky uplatňuje prostřednictvím Obchodního Partnera vyplněním reklamačního formuláře a dodáním výrobku nebo fotodokumentace (pokud není možná demontáž), stříbrného štítku na zadní části radiátoru a dokladu o koupi. Nebudeli kterýkoli z výše uvedených dokladů předložen, bude Výrobce oprávněn nahlášenou reklamaci nebo stížnost odmítnout.

E. Výrobce projednává reklamaci z titulu poskytnuté záruky v lhůtě 14 kalendářních dnů ode dne jejího přijetí, nebo v době delší, stanovené individuálně, jestliže reklamace vyžaduje odborné posouzení výrobku. Reklamace je projednávána na základě dodaného výrobku nebo fotodokumentace. V případě Uznání reklamace se Výrobce zavazuje opravit nebo dodat nový výrobek. Termín dodání je dohodnut s Klientem individuálně. Garanční oprava nezahrnuje činnosti popsané v Návodu k montáži a obsluze. Ty musí provádět klient sám.

- F. Náklady na výměnu výrobku vyplývající z reklamace, jako jsou náklady na demontáž, dodávku výrobku Spotřebiteli, práce a opětovná montáž a uvedení do provozu, jsou účtovány Obchodnímu Partnerovi (tj. podnikateli, který produkt přímo prodává Spotřebiteli). Případný podíl Výrobce na nákladech spojených s výměnou nebo vrácením nákladů Obchodnímu Partnerovi je stanoven dle individuální dohody mezi Výrobce a Obchodním Partnerem. Náklady na výměnu výrobku za nový včetně jeho dodání Obchodnímu Partnerovi jsou účtovány Výrobci.
- G. Reklamací lze podat prostřednictvím:
- internetového formuláře uvedeného na stránkách Výrobce www.termahat.com,
 - Emailu s příložením všech potřebných příloh, údajů a popisu uvedených na: <https://cz.termahat.com/porady/postup-p%C5%99i-%C5%99e%C5%A1en%C3%AD-reklamac>
- H. Záruka se vztahuje na všechny vady výrobku způsobené zaviněním Výrobce, zjištěné po dodání výrobku nebo v průběhu jeho použití. Záruka se nevztahuje na:
- poškození při přepravě způsobené dopravcem nebo vzniklé během vykládky zboží (vztahuje se pouze na vztah mezi Obchodním Partnerem a Výrobce). Podmínky pro přijetí stížnosti týkající se poškození při přepravě jsou uvedeny v bodě 4E,
 - poškození během skladování (otopné těleso přijaté k uskladnění je považováno za výrobek, který nemá vady.
 - skladování produktů v otevřených prostorách nebo místnostech s vysokou vlhkostí,
 - zásobování radiátorů médii, které se odchyluje od standardu přijatého pro daný typ výrobku (např. pára), použití topného média obsahujícího agresivní sloučeniny, které poškozují materiál, ze kterého je vyrobeno topné těleso, tj. ocel, litina nebo hliník,
 - zásobování radiátorů topným médiem s pracovním tlakem, který přesahuje normativní požadavky uvedené v návodu k použití nebo technické dokumentaci výrobku nebo způsobení zvýšení tlaku v radiátoru během používání namontované topné tyče při uzavřených obou ventilech, nebo když se nechá málo volného prostoru pro roztažnost média v elektrickém radiátoru,
 - mechanického či jiného poškození zaviněného Klientem po převzetí od Prodejce
 - používání výrobků v rozporu s Návodem,
 - poškození elektrických topných tyčí při používání pro jiné než Výrobce předepisované výkony atd.
 - použití v místnostech s přítomností agresivních látek v atmosféře, jako jsou sloučeniny síry, amoniaku a chloru apod. s koncentracemi převyšujícími normální podmínky,
 - montáž ocelových radiátorů v otevřených otopných systémech s přímým připojením na přívod vody a v systémech, ve kterých dochází častěji k vypouštění topného média, než to určují nezbytné provozní požadavky,
 - použití elektrických radiátorů s vystavením topného prvku vodním stříkancům (bez ohledu na stupeň ochrany výrobku),
 - nesprávnou (v rozporu s návodem) montáž, demontáž nebo nesprávné použití
 - použití topného prvku způsobem, který je v rozporu s jeho zamýšleným použitím,
 - zásah do konstrukce zařízení
- I. Záruka se rovněž nevztahuje na poškození způsobená tzv. Vyšší mocí, chápaná jako mimořádná, nepředvídatelná, nezaviněná událost (např. atmosférické události, poruchy elektrických zařízení, válka, přírodní katastrofy)
- J. Doba trvání postupu při vyřizování reklamací, není důvodem k odmítnutí platby za dodané zboží.
- K. Provádění změn a manipulace s výrobkem (pokud jde o strukturu, povrchovou úpravu atd.) Obchodním partnerem nebo Koncovým klientem má za následek ztrátu záruky.
- L. Návod k výrobku je nedílnou součástí záruky. Před zahájením montáže a provozu výrobku je nutné si přečíst jeho obsah.
- 6. Postup při vyřizování reklamací topných tyčí pro zahraniční Obchodní Partnery z EU, kteří nedrží nastavené zásoby skladem:**
- A. Obchodní Partner označí topnou tyč, kterou obdržel od Spotřebitele reklamačním číslem.
- B. Obchodní Partner provede předběžné posouzení např. podle vzhledu na základě materiálů obdržených od Výrobce. V případě zjevných poškození, která vznikla v důsledku nesprávného používání výrobku má Obchodní Partner právo samostatně odmítnout reklamaci.
- C. Veškeré reklamace by měly být doručeny Výrobci ve formě reklamačního formuláře prostřednictvím webového formuláře, spolu s min. 2 fotografiemi (např. přední a boční strany celé topné tyče, vady výrobku a foto namontovaného celého výrobku včetně instalace v okolí).
- D. Výrobce zaeviduje reklamaci do svého systému a po ověření fotografií, Neexistují-li jasné důvody pro zamítnutí reklamace, zahájí předběžné vypořádání reklamace:
- vystaví opravný doklad (dobropis) nebo
 - zašle novou topnou tyč na výměnu na základě dokladu o vydání zboží ze skladu;
 - v případě Obchodního Partnera, který má větší množství výrobků skladem vyřizování reklamace může být zahájeno ihned po ověření vráceného výrobku Výrobci
- E. Prodejní doklad (faktura) a doklad o vydání zboží ze skladu budou označeny reklamačním číslem Obchodního Partnera.
- F. Všechny topné tyče, které byly předmětem reklamace (s výjimkou těch, které byly předem zamítnuty) podléhají povinnému vrácení Výrobci. Osoba zodpovědná za obchod se dohodne s Obchodním Partnerem, jaká bude doba shromažďování topných tyčí, po uplynutí které Výrobce vyzvedne zboží. Vyzvednutí topných tyčí, které byly předmětem reklamace probíhá nejméně jednou za tři měsíce.
- G. V případě, kdy Obchodní Partner nevrací všechny topné tyče z daného období, automaticky hradí cenu zboží (vystavení faktury).

- H. Vracené topné tyče podléhají podrobnému odbornému posudku, v důsledku jeho provedení vznikne seznam topných tyčí, u kterých byla uznána reklamáce (vada produktu) a rovněž těch zamítnutých (použití v rozporu s návodem, jiné vady, které nebyly způsobeny vinou Výrobce).
- I. Na základě shrnutí odborných posudků, jež je správné vyřizování reklamáce probíhá konečné vypořádání s Obchodním Partnerem. V případě topných tyčí, u kterých byla uznána reklamáce se předběžné vypořádání reklamáce nemění.
- J. Obchodní Partner obdrží shrnutí odborných posudků a v případě zamítnutých reklamací měl by předat Spotřebiteli informace o důvodech rozhodnutí o zamítnutí reklamáce, spolu s pokyny k používání produktu.
- K. Každý koncový zákazník, a zejména ten, který nahlásil reklamaci, měl by obdržet od Obchodního Partnera brožuru „Topné tyče - čemu je třeba věnovat pozornost před montáží“.
- L. Výše uvedený postup nevyklučuje schéma činností, které se uplatňuje pro většinu Obchodních Partnerů z území EU, tj. shromažďování v dohodnutém období topných tyčí, které byly předmětem reklamáce, vrácení většího množství zboží na účet Výrobce a obdržení vypořádání teprve po zpracování odborného posudku výrobku.

7. Závěrečná ustanovení.

- A. Vlastnictví prodaného zboží je vyhrazeno Výrobci až do zaplacení celkové ceny Obchodním Partnerem, což znamená, že Obchodní Partner se stává vlastníkem obdrženého zboží okamžikem úhrady všech částek vůči Výrobci.
- B. Obchodní Partner je povinen zachovávat mlčenlivost o údajích, týkajících se veškerých technických, technologických, obchodních a organizačních podrobností (včetně cen, slev, jiných obchodních podmínek) získaných jakýmkoli způsobem, a především tyto informace by neměly být nikdy zveřejněny. Tato povinnost existuje jak během obchodní spolupráce mezi Výrobcem a Obchodním Partnerem, tak i po jejím ukončení. Údaje mohou být zveřejněny třetím stranám pouze s písemným souhlasem Výrobce.
- C. Veškeré spory, neshody, které mohou vzniknout mezi Výrobcem a Obchodním Partnerem ve vztahu k těmto podmínkám, objednávkám, reklamacím a uzavřeným dohodám, budou řešeny nejprve smírně. Nebude-li smírného řešení dosaženo, budou spory řešeny v soudním řízení příslušným soudem pro sídlo Výrobce. Rozhodným právem pro řešení sporů je právo Polské republiky. V případě rozdílu v překladech těchto podmínek spolupráce, rozhodující význam má verze v polštině.
- D. Tyto podmínky platí od 3.1.2024.
- E. Ostatní podmínky, změny a dodatky, které nejsou obsaženy v tomto dokladu, ke své platnosti vyžadují v každém případě výslovné písemné potvrzení ze strany Výrobce.

Tabulka přepočtu pro jiné než nejčastější parametry instalace

T1 [°C]	T2 [°C]	Ti [°C]					
		5	8	12	16	20	24
95	85	0.50	0.52	0.56	0.60	0.64	0.70
	80	0.52	0.55	0.59	0.63	0.68	0.73
	75	0.54	0.57	0.61	0.66	0.72	0.78
	70	0.57	0.60	0.65	0.70	0.76	0.83
90	80	0.54	0.57	0.61	0.66	0.71	0.77
	75	0.57	0.60	0.64	0.69	0.75	0.82
	70	0.59	0.63	0.67	0.73	0.80	0.87
	65	0.62	0.66	0.71	0.78	0.85	0.94
85	75	0.59	0.62	0.67	0.72	0.79	0.86
	70	0.62	0.65	0.71	0.77	0.84	0.92
	65	0.65	0.69	0.75	0.81	0.89	0.99
	60	0.69	0.73	0.79	0.87	0.96	1.07
80	70	0.64	0.68	0.74	0.81	0.88	0.97
	65	0.68	0.72	0.78	0.86	0.94	1.05
	60	0.72	0.76	0.83	0.92	1.02	1.14
	55	0.76	0.81	0.89	0.99	1.10	1.24
75	65	0.71	0.75	0.82	0.90	1.00	1.12
	60	0.75	0.80	0.88	0.97	1.08	1.21
	55	0.80	0.85	0.94	1.04	1.17	1.33
	50	0.85	0.91	1.01	1.13	1.29	1.48
70	60	0.79	0.84	0.93	1.03	1.15	1.30
	55	0.84	0.90	0.99	1.11	1.25	1.42
	50	0.89	0.96	1.07	1.21	1.37	1.59
	45	0.96	1.04	1.17	1.33	1.53	1.80
65	60	0.83	0.89	0.98	1.10	1.23	1.40
	55	0.88	0.95	1.05	1.18	1.34	1.54
	50	0.94	1.02	1.14	1.29	1.48	1.72
60	55	0.93	1.01	1.13	1.27	1.45	1.68
	50	1.00	1.08	1.22	1.39	1.60	1.88
	45	1.08	1.17	1.33	1.53	1.79	2.14
55	50	1.07	1.16	1.31	1.50	1.75	2.07
	45	1.15	1.26	1.43	1.66	1.96	2.37
	40	1.25	1.38	1.59	1.87	2.25	2.80
50	45	1.23	1.35	1.56	1.82	2.17	2.67
	40	1.34	1.49	1.73	2.05	2.50	3.16
	35	1.48	1.65	1.95	2.37	2.98	3.96
45	40	1.45	1.62	1.90	2.28	2.83	3.66
	35	1.60	1.80	2.15	2.64	3.38	4.61

T1 – teplota vstupu topné vody

T2 – teplota výstupu(vratky)

Ti – požadovaná teplota v místnosti

Legenda



Radiátor ve verzi vodní, ÚT



Radiátor připraven pro kombinaci vodně – el., se zapojenou topnou tyčí



Radiátor ve verzi elektrické, suchý s topným kabelem nebo naplněný olejem s topnou tyčí. Výrobek je továrně testován a připraven po zapojení do zásuvky k okamžitému užívání.



Radiátor dostupný i v chromovaném povrchu.



Výběr ze všech RAL v lesku a Speciálních barev je za stejnou cenu.



Výběr z nabízených připojení v ceně radiátoru



Základní možnost připojení radiátoru. Ikona označuje způsob vstupu topné vody a zpátečky v daném připojení a umístění termostatické hlavice a topné tyče, pokud je možné je namontovat.



Výkon elektrického radiátoru nebo předepsaný výkon topné tyče pro radiátor vodní ÚT.



Váha





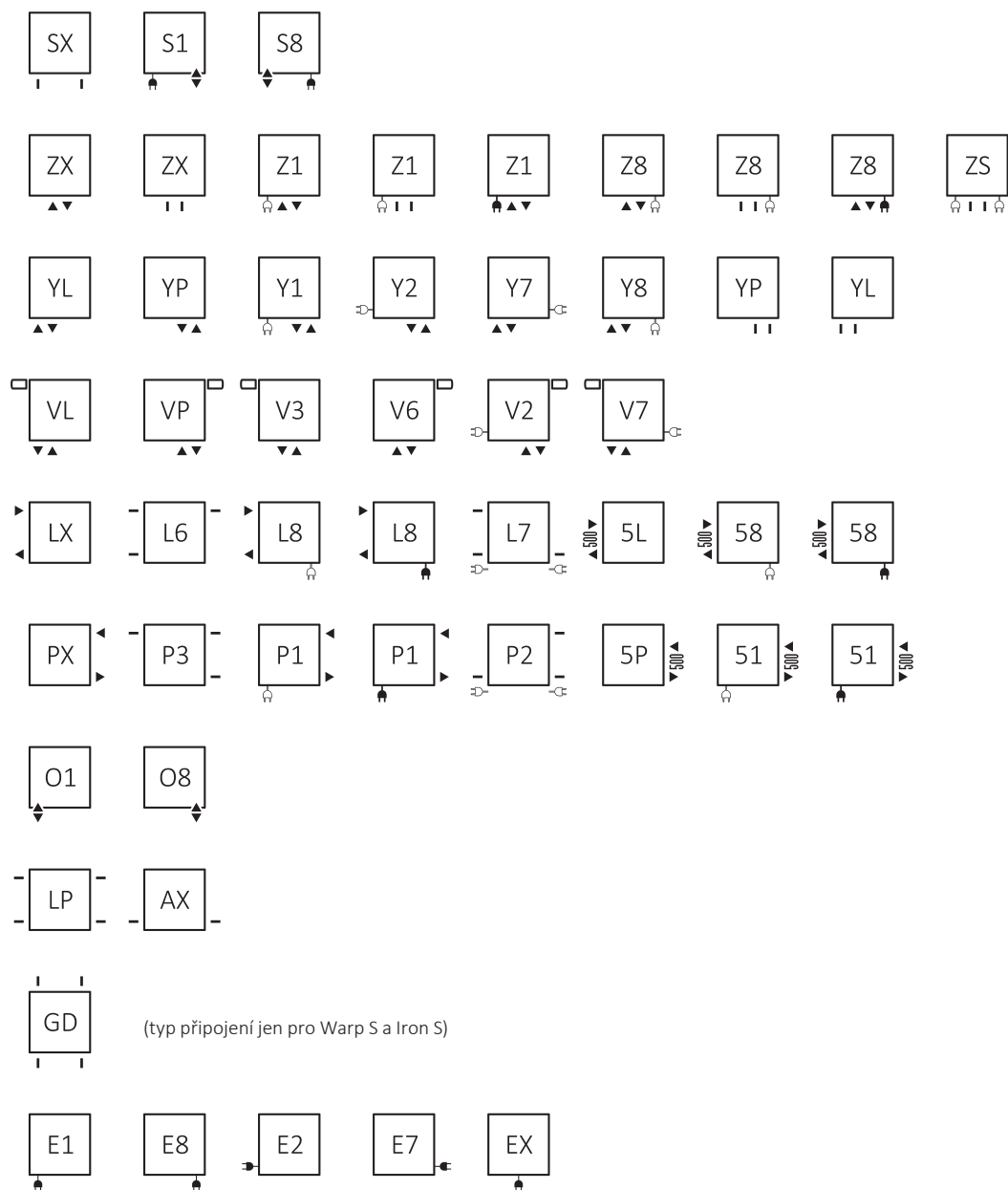

Objem

Výběr připravení otvorů pro připojení



(typ připojení jen pro Warp S a Iron S)

Vysvětlivky

- 
 čárky označují jen připravení připojovacích otvorů s 1/2" vnitřním závitem, kdy vnitřní konstrukce radiátoru umožňuje libovolný vstup a výstup topné vody. POZOR - záleží však na konstrukci ventilu a kudy udává vstup a výstup topné vody. (u SX ventil s ponornou trubicí umožňuje využít jeden otvor pro vstup i výstup a druhý otvor pro topnou tyč)
- 
 označují povinné připravení vstupu a výstupu topné vody topenářskou firmou, kvůli vnitřní konstrukci v radiátoru
- 
 označení místa otvoru možného připojení libovolné TERMA topné tyče
- 
 označení místa zabudované topné tyče ONE

Konstrukce kódu konfigurace Vodního radiátoru ÚT (kód začíná „WG“)

Kódy produktů najdete v tabulkách výrobků v katalogu nebo ceníku a poskytují informace o verzi, názvu a rozměru. Pro další specifikaci produktu jako barva, typ připojení, topná tyč a druh kabelu je třeba kódy produktů doplnit o Vámi vyspecifikovaný KONFIGURAČNÍ KÓD. Konfigurační kód by měl být umístěn v řetězci znaků po kódu produktu, jak uvádí příklad níže:

KONSTRUKCE KÓDU



WG – Radiátor vodní zapojený do systému ústředního topení ÚT. Při objednání samostatné další položky topné tyče z něj lze udělat kombinovaný vodně-elektrický radiátor.

Konstrukce kódu konfigurace Kombinovaného radiátoru vodně-elektrického se zabudovanou topnou tyčí ONE (kód začíná „WZ“)

Kódy produktů najdete v tabulkách výrobků v katalogu nebo ceníku a poskytují informace o verzi, názvu a rozměru. Pro další specifikaci produktu jako barva, typ připojení, topná tyč a druh kabelu je třeba kódy produktů doplnit o Vámi vyspecifikovaný KONFIGURAČNÍ KÓD. Konfigurační kód by měl být umístěn v řetězci znaků po kódu produktu, jak uvádí příklad níže:

KONSTRUKCE KÓDU

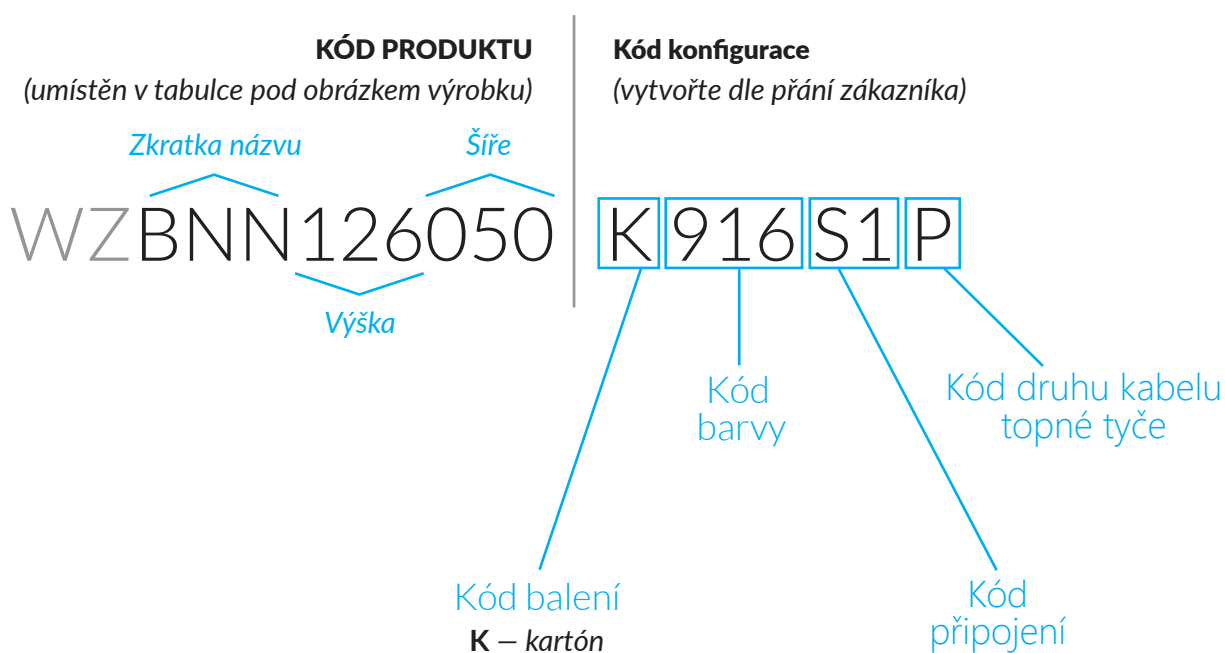

WZ – Kombinovaný radiátor vodně-elektrický se zabudovanou topnou tyčí ONE

Konstrukce kódu konfigurace Elektrického radiátoru uzavřeného, naplněného olejem a zabudovanou topnou tyčí ONE (kód začíná „WW“)

Kódy produktů najdete v tabulkách výrobků v katalogu nebo ceníku a poskytují informace o verzi, názvu a rozměru. Pro další specifikaci produktu jako barva, typ připojení, topná tyč a druh kabelu je třeba kódy produktů doplnit o Vámi vyspecifikovaný KONFIGURAČNÍ KÓD. Konfigurační kód by měl být umístěn v řetězci znaků po kódu produktu, jak uvádí příklad níže:

KONSTRUKCE KÓDU

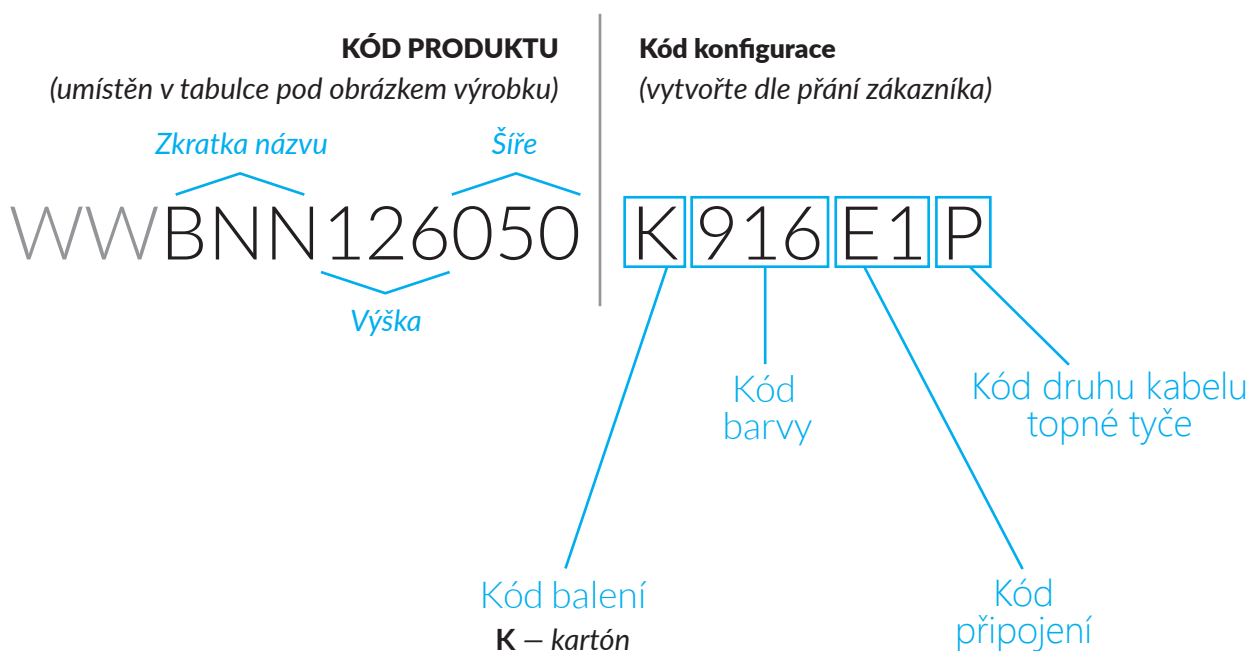

WW – Elektrický radiátor uzavřený naplněný olejem a zabudovanou topnou tyčí ONE

Konstrukce kódu konfigurace Elektrického radiátoru uzavřeného naplněného olejem a zvolenou topnou tyčí - např. KTX, MOA, REG i ONE v 8cm profilu (kód začíná „WL“)

Kódy produktů najdete v tabulkách výrobků v katalogu nebo ceníku a poskytují informace o verzi, názvu a rozměru. Pro další specifikaci produktu jako barva, typ připojení, topná tyč a druh kabelu je třeba kódy produktů doplnit o Vámi vyspecifikovaný KONFIGURAČNÍ KÓD. Konfigurační kód by měl být umístěn v řetězci znaků po kódu produktu, jak uvádí příklad níže:

KONSTRUKCE KÓDU

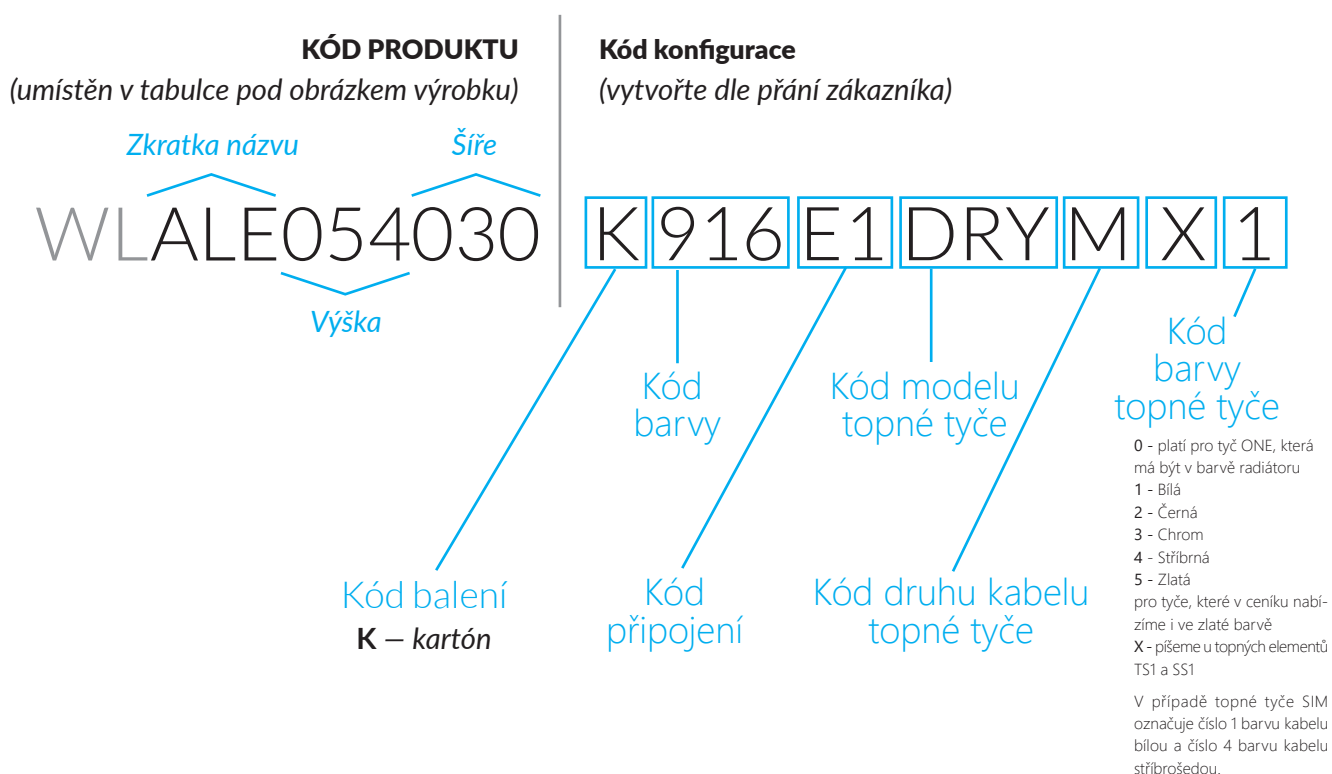

Pro topné tyče ze 2 částí (řada KTX a VEO) pište do kódu modelu a druhu kabelu kód TS1D (topný element, který uzavře naplněný radiátor) a samostatně jako další položku objednejte vybraný regulátor z řady KTX, nebo SS1D a samostatně objednejte regulátor VEO.

WL – Elektrický radiátor uzavřený naplněný olejem s nainstalovanou zvolenou topnou tyčí (např. TS1 - topný element, MOA, REG i ONE v 8cm profilu)

Konstrukce konfiguračního kódu pouze pro 2 typy Elektrických suchých radiátorů Perla E a Spiro - suché s topným kabelem v celém těle (kód začíná „WS“)

Kódy produktů najdete v tabulkách výrobků v katalogu nebo ceníku a poskytují informace o verzi, názvu a rozměru. Pro další specifikaci produktu jako barva, typ připojení, topná tyč a druh kabelu je třeba kódy produktů doplnit o Vámi vyspecifikovaný KONFIGURAČNÍ KÓD. Konfigurační kód by měl být umístěn v řetězci znaků po kódu produktu, jak uvádí příklad níže:

KONSTRUKCE KÓDU

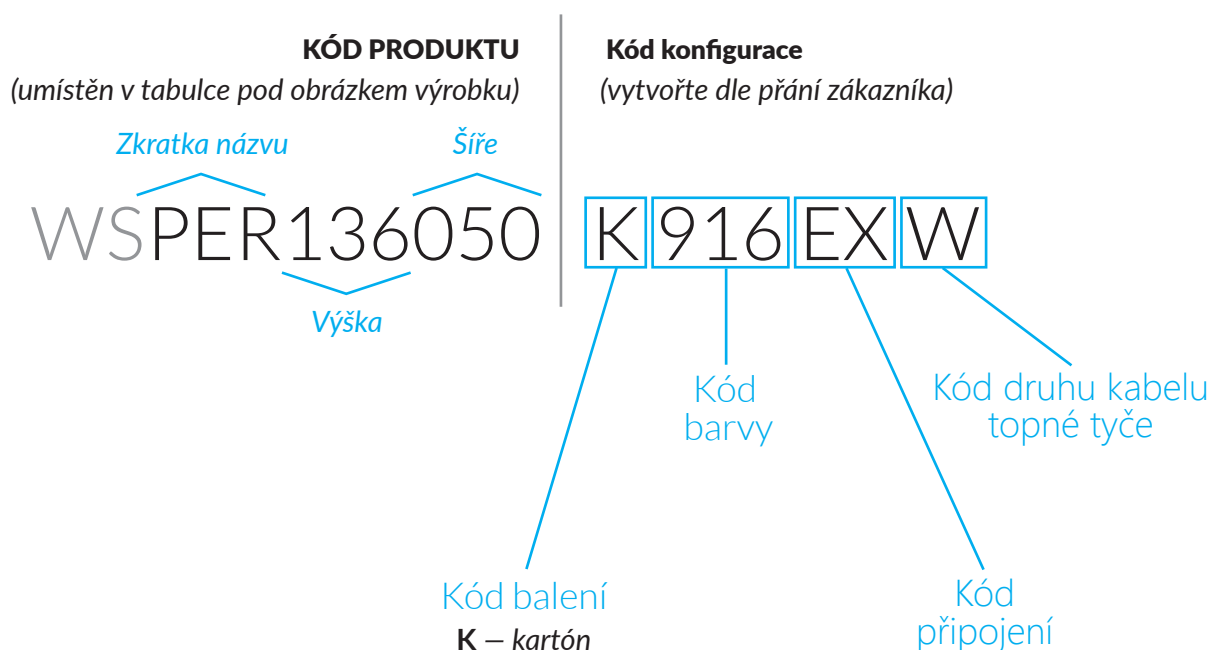

WS – Elektrický radiátor suchý s topným kabelem

Konstrukce konfiguračního kódu konfigurovatelného Příslušenství (kód začíná „WR“)

Kódy produktů najdete v tabulkách výrobků v katalogu nebo ceníku a poskytují informace o verzi, názvu a rozměru. Pro další specifikaci produktu jako barva, typ připojení, topná tyč a druh kabelu je třeba kódy produktů doplnit o Vámi vyspecifikovaný KONFIGURAČNÍ KÓD. Konfigurační kód by měl být umístěn v řetězci znaků po kódu produktu, jak uvádí příklad níže:

KONSTRUKCE KÓDU



WR – Příslušenství konfigurovatelné, např. háčky, držáky ručníků, vše kde se upřesňuje už jen barva Produktu.

Konstrukce konfiguračního kódu Opláštění CASE SLIM s barevným sklem, zrcadlem nebo sklem s potiskem (kód začíná „WR“)

Kódy produktů najdete v tabulkách výrobků v katalogu nebo ceníku a poskytují informace o verzi, názvu a rozměru. Pro další specifikaci produktu jako barva, typ připojení, topná tyč a druh kabelu je třeba kódy produktů doplnit o Vámi vyspecifikovaný KONFIGURAČNÍ KÓD. Konfigurační kód by měl být umístěn v řetězci znaků po kódu produktu, jak uvádí příklad níže:

KONSTRUKCE KÓDU



WR – Příslušenství konfigurovatelné

Konstrukce konfiguračního kódu elektrického přímotopu SMART Wi-Fi VOLTAN (kód začíná „WK”)

Kódy produktů najdete v tabulkách výrobků v katalogu nebo ceníku a poskytují informace o verzi, názvu a rozměru. Pro další specifikaci produktu jako barva, typ připojení, topná tyč a druh kabelu je třeba kódy produktů doplnit o Vámi vyspecifikovaný KONFIGURAČNÍ KÓD. Konfigurační kód by měl být umístěn v řetězci znaků po kódu produktu, jak uvádí příklad níže:

KONSTRUKCE KÓDU

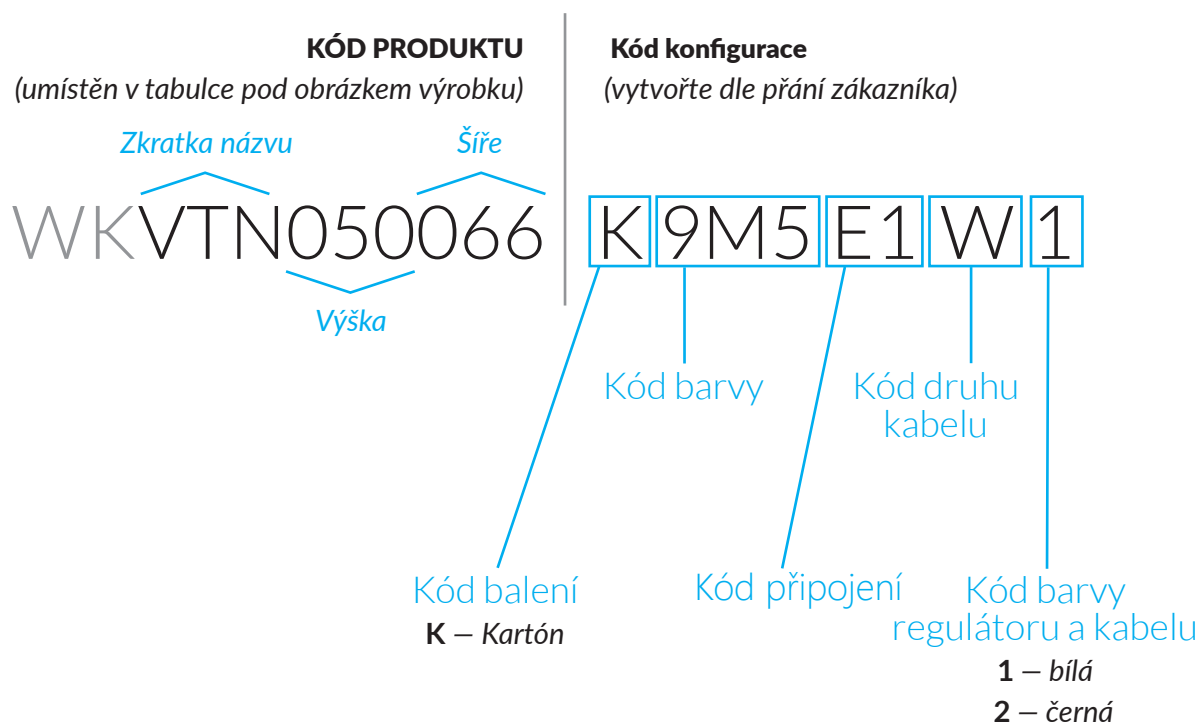

WK – elektrický přímotop Voltan

Konstrukce konfiguračního kódu příslušenství SMART Wi-Fi VAZ, VOS, VTS (kód začíná „WI“)

Kódy produktů najdete v tabulkách výrobků v katalogu nebo ceníku a poskytují informace o verzi, názvu a rozměru. Pro další specifikaci produktu jako barva, typ připojení, topná tyč a druh kabelu je třeba kódy produktů doplnit o Vámi vyspecifikovaný KONFIGURAČNÍ KÓD. Konfigurační kód by měl být umístěn v řetězci znaků po kódu produktu, jak uvádí příklad níže:

KONSTRUKCE KÓDU

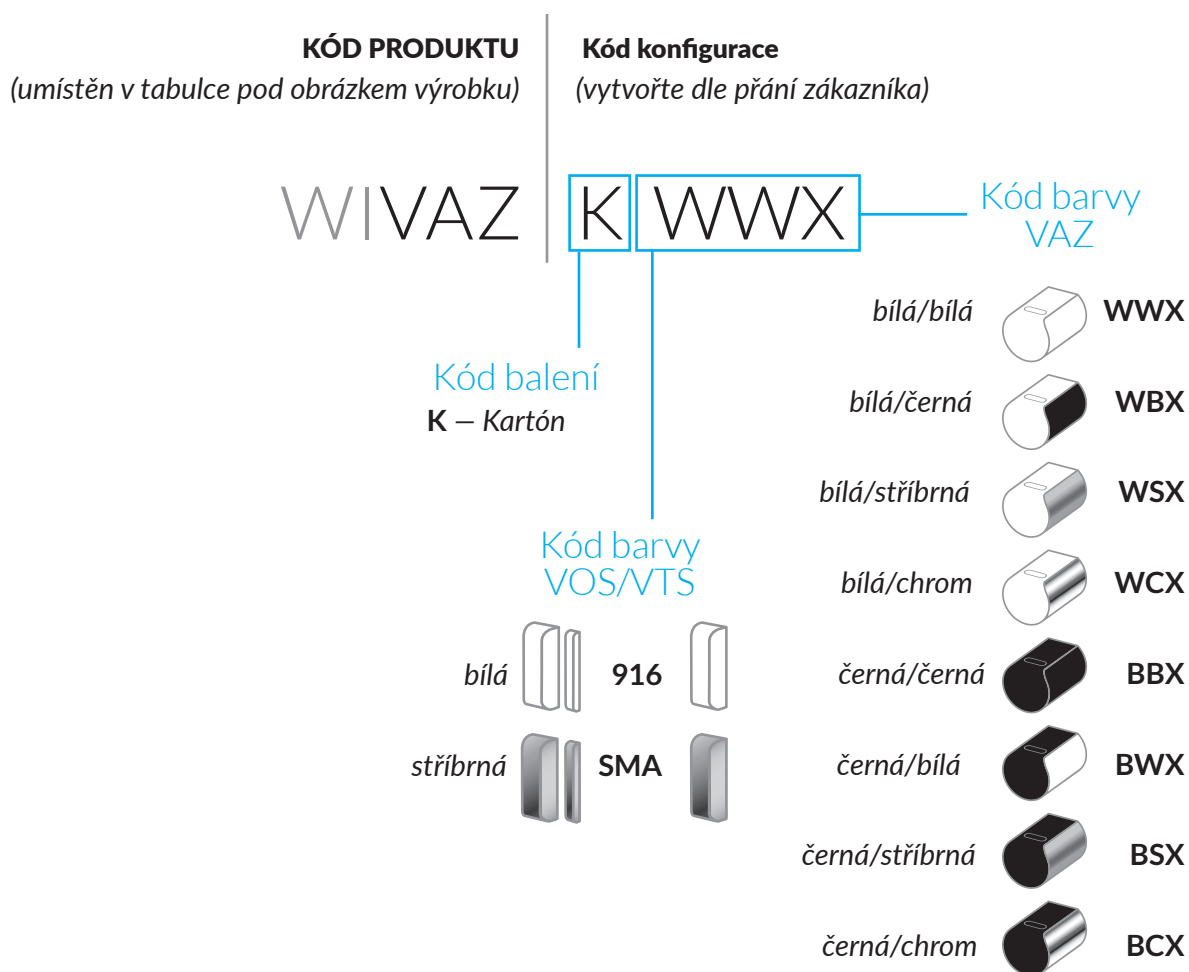

Otázky pro specifikaci radiátoru a tvoření Objednacího kódu

Kódy výrobků najdete v tabulkách výrobků v katalogu nebo ceníku a poskytují informace o verzi, názvu a rozměru.

Pro další specifikaci produktu jako barva, typ připojení, topná tyč a druh kabelu je třeba kódy produktů doplnit o Vámi vyspecifikovaný KONFIGURAČNÍ KÓD.

Konfigurační kód by měl být umístěn v řetězci znaků po kódu produktu:

Každopádně pro vytvoření obou kódů je potřeba si s klientem zodpovědět těchto 8 otázek:

1. Potřebuje zákazník radiátor vodní, vodně-elektrický nebo čistě elektrický?
2. Jaký model (název radiátoru) si zákazník vybral?
3. Jaký rozměr z nabídky TERMA daného modelu si zákazník vybral?
4. Jakou barvu ze vzorníku TERMA RAL, TERMA Speciální barvy nebo TERMA barvy PREMIUM si klient vybral?
5. Jaký typ připojení (na střed, do krajů atd.) si klient po konzultaci s prodejcem nebo svým topenářem vybral (viz možné typy připojení označeny zkratkou a symbolem u všech radiátorů)?
6. Pokud si přál zákazník vodně-elektrický nebo elektrický radiátor, tak jaký typ topné tyče si dle vzhledu, barvy, funkcí, ovládání vybral?
7. Jaký druh kabelu si zákazník vybral od topné tyče (přímý do zdi bez zástrčky, kroucený nebo přímý se zástrčkou, přímý do zdi s krytkou kabelu)?
8. Jakýkoliv nadstandard, developerské větší množství radiátorů nebo atyp požadavek na rozměr, vzhled, uspořádání, barvu, připojení, délku kabelu (pište slovně do závorek za konec kódů a s objednávkou posílejte vždy i obdrženou cenovou nabídku Regionálního manažera na developerské nebo atyp řešení).

Kontakt

Terma Sp. z o.o.

Czaple 100
80-298 Gdańsk
NIP: 583-10-18-844
www.termaheat.com
M: +48 607 451 076

Regionální Manager

Jiří Lakosil
M: +420 774 924 084
Jiri.Lakosil@termagroup.pl

Objednávky zasílejte na:

orders-heating@termagroup.pl

Kontrola a dotazy na stav objednávek:

Agnieszka.Blizniewska@termagroup.pl

Řecko, Slovensko, Česká Republika, Kypr

+420 774 924 084

Německo (Region Jih)

+ 49 171 528 1085

Německo (Region Sever)

+ 49 171 528 1082

Německo (Region Západ)

+ 49 171 528 1090

Rakousko, Německo, Švýcarsko

+ 48 607 451 306
+ 48 887 022 427

Nizozemí, Lucembursko

+ 48 607 451 947

Velká Británie, Irsko, Austrálie, Nový Zéland

+ 44 (0)1942 272 172 (UK Office)
+ 44 (0)7375 519 211
+ 48 607 451 960

Francie

+ 33 6 99 91 01 01
+ 48 607 451 035

Belgie, Portugalsko, Španělsko

+ 48 607 451 035

Itálie

+ 39 347 786 386 0
+ 48 607 451 035

Dánsko, Finsko, Švédsko, Island, Norsko, Turecko

+ 48 607 451 984

Litva, Lotyšsko, Estonsko

+ 48 607 779 066

Bělorusko, Moldávie, Ukrajina, Kazachstán

+ 48 607 451 202

Rusko

МО, Ленинский район, ГП Видное, д. Апаринки,
стр.1, корпус 2, 2 этаж
+7 963 644 34 36
+7 963 644 34 37
+7 963 644 34 38
+7 963 644 34 39

Bosna a Hercegovina, Chorvatsko, Severní Makedonie, Srbsko, Slovinsko, Maďarsko

+420 774 924 084

Uvedené informace byly aktuální v době zveřejnění. Základním principem firmy Terma je neustálé zlepšování kvality výrobku, a proto tyto informace nejsou závazné a mohou se měnit bez předchozího oznámení. Společnost Terma si vyhrazuje právo provést změny ve verzích prezentovaných produktů. Obrázky použité v tomto ceníku mají pouze ilustrativní charakter a nejsou předmětem nabídky.



Terma Sp. z o.o.
Czaple 100
80-298 Gdańsk
NIP: 583-10-18-844
www.termaheat.com